

WARNING

- * Switch off the main electrical supply from the main fuse box / circuit breaker before installation.
- * Inspect item carefully before attempting to install.
- * If there is any damages or obvious defects, do not install.
- * Item may not be returned once it has been installed.

CARE AND MAINTENANCE

- * To clean the outside of the fixture, use a dry or slightly dampened clean cloth (use clean water, never a solvent) to wipe the surface of the fixture.
- * To clean the inside of the fixture, first disconnect power to the fixture by turning off the circuit breaker or by removing the fuse at the fuse box. Next, use a dry or slightly dampened clean cloth (use clean water, never a solvent) to wipe the interior surface of the fixture.
- * Do not use any cleaners with chemical, solvents or harsh abrasives. Use only a dry soft cloth to dust or wipe carefully.







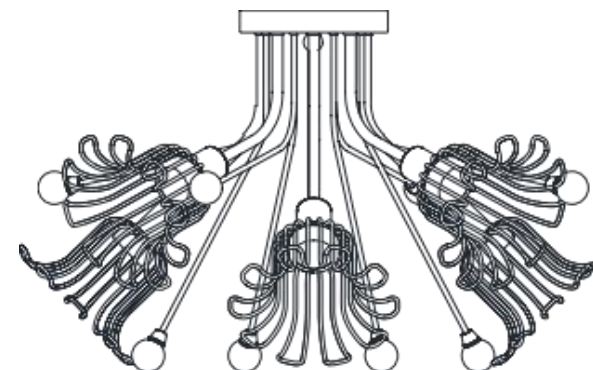





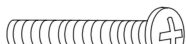

NOTICE& IMPORTANT SAFETY INSTRUCTIONS

- ** WE RECOMMEND INSTALLATION OF THIS LIGHTING FIXTURE BE DONE BY A LICENSED ELECTRICIAN **
- * Please make sure that you have all parts indicated before you begin assembly of this item
- * This item should be assembled on a soft surface to prevent scratching the finish during assembly
- * To reduce the risk of fire, electrical shock or injury to persons or property, please follow the guideline below for safe use and installation
- *The external flexible cable or cord of this lamp cannot be replaced
If the cord is damaged, the lamp shall be destroyed

Product Dimensions: 19"L X 19"W X12.75"H



Part List and Hardware List

PIECE	DESCRIPTION	PICTURE	QUANTITY	PIECE	DESCRIPTION	PICTURE	QUANTITY
A	Mounting bracket		1X	H	Fixture body		1X
B	Support screw		2X	I	Frame		8X
C	Outlet box screw		2X	J	Socket ring		8X
D	Green ground screw		1X	K	Arm (long)		4X
E	Wire connector		3X	L	Arm (short)		4X
F	Wrench		1X	M	Hex nut		8X
G	Bulb		8X	N	Washer		8X

PREPARATION

- * Before beginning assembly of product, make sure all parts are present. Compare parts with package contents list and hardware contents list.
- * If any part is missing or damaged, do not attempt to assemble the product.
- * Estimated Assembly Time: 15 minutes.
- * Tools Required for Assembly (not included): Screwdriver, Junction box
- * If you are having difficulty, our friendly Customer Care team is always here to help.

NOTE: PLEASE USE TYPE "B" BULB MAX 25-WATT OR LED BULB MAX 5-WATT, THERE IS LED 4-WATT BULB IN THE BOX

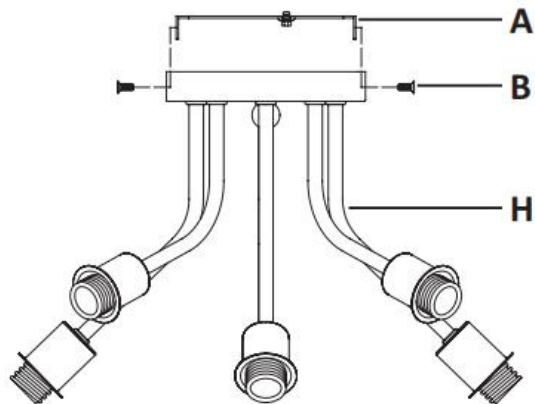

Step 1: Unscrew the two support screws (B) from the mounting bracket (A). Remove the mounting bracket (A) from the canopy of the fixture body (H) and keep the mounting bracket (A) and two support screws (B) for later use.

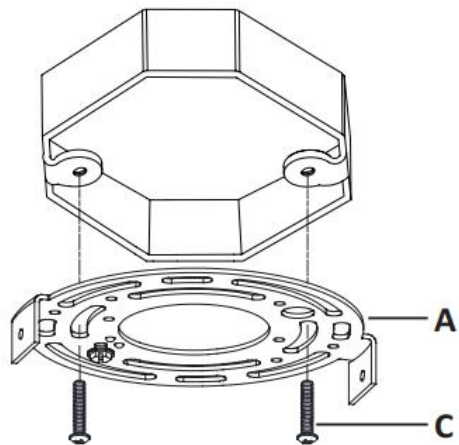

Step 2: Fasten the mounting bracket (A) onto the outlet box using two outlet box screws (C).

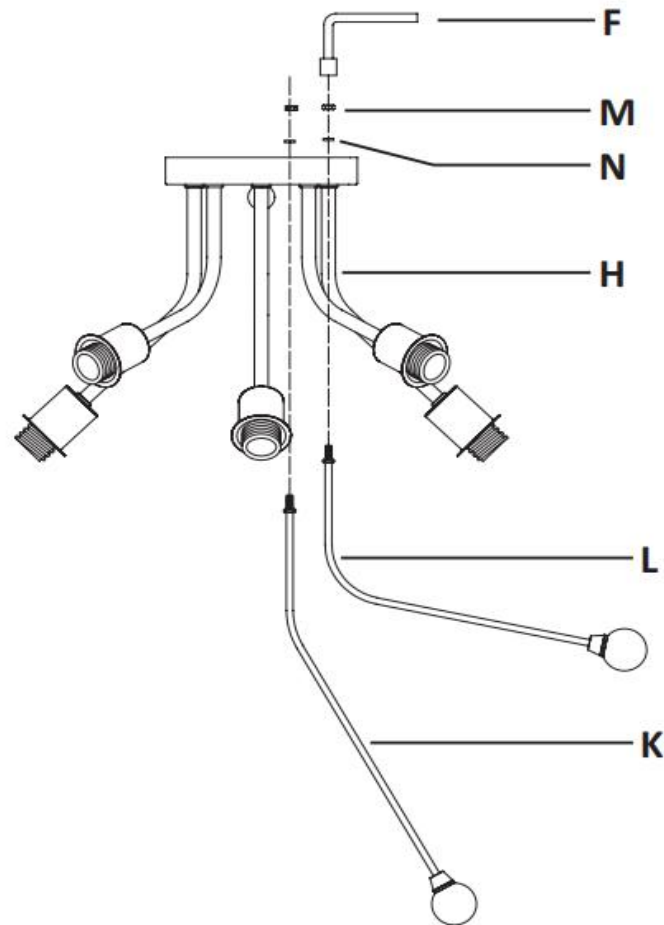

Step 3: Insert the screw of the arm (long) (K) and the arm (short) (L) to the hole of the canopy of the fixture body (H) adjacent to each other, then secure with the hex nut (M) and washer (N) by the wrench (F). Adjust the arms (long) (K) and the arms (short) (L) to make an equal distance between them.

PREPARATION

- * Before beginning assembly of product, make sure all parts are present. Compare parts with package contents list and hardware contents list.
- * If any part is missing or damaged, do not attempt to assemble the product.
- * Estimated Assembly Time: 15 minutes.
- * Tools Required for Assembly (not included): Screwdriver, Junction box
- * If you are having difficulty, our friendly Customer Care team is always here to help.

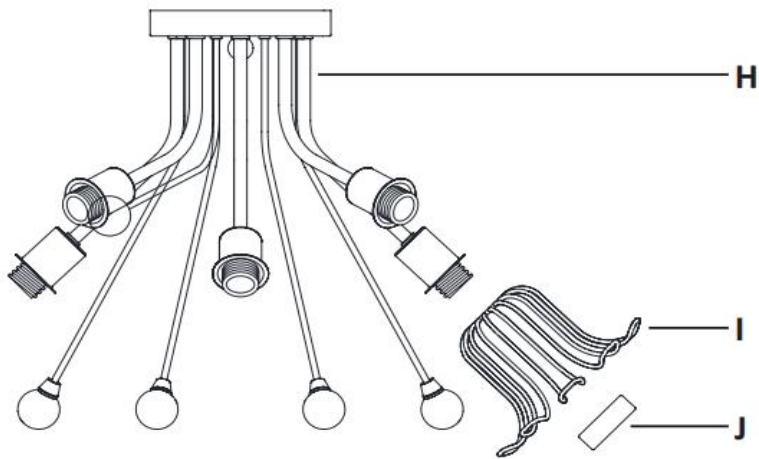

Step 4: Unscrew the socket ring (J) from the socket, place the frame (I) over the socket and secure with the socket ring (J).



Step 5: Wire connection.

Connect fixture neutral wire (ribbed) to the outlet box neutral wire (usually white) using a wire nut. Connect fixture hot wire (smooth with markings) to the outlet box hot wire (usually black) using a wire nut. CAUTION: Do not reverse the hot and neutral connections.

Grounding Instructions: Wrap ground wire from outlet box around ground screw on mounting plate, no less than 2" from wire end. Tighten ground screw. If fixture is supplied with a ground wire, connect to outlet ground wire with a wire nut.

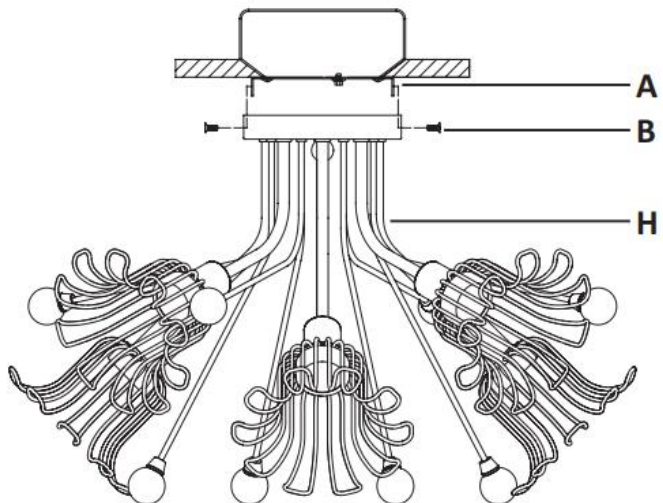

Step 6: Place the canopy of the fixture body (H) over the outlet box, align the two holes of the mounting bracket (A) and the canopy of the fixture body (H), then tighten the support screws (B).

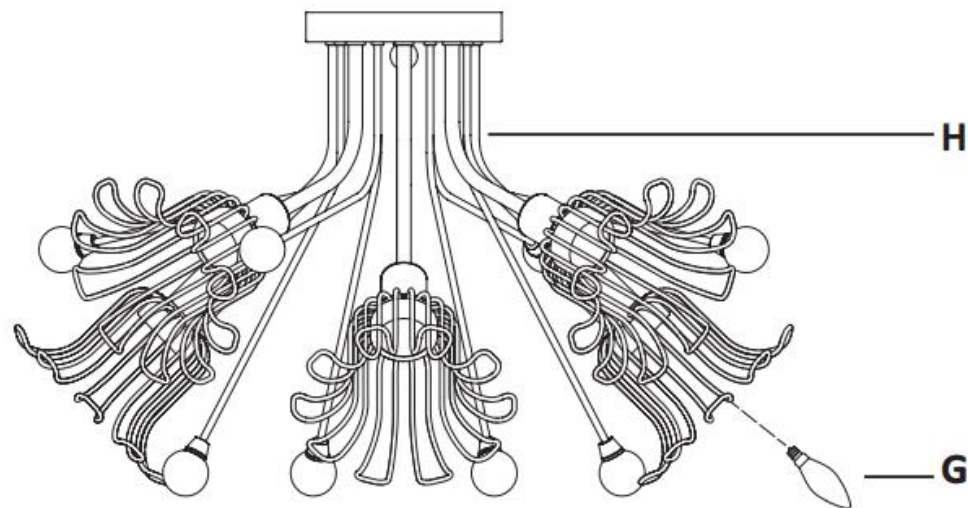

Step 7: Install the light bulbs (G) into the socket of the fixture body (H).