

**OWNER'S MANUAL & INSTALLATION INSTRUCTIONS**  
**(For 5ft, 6ft, 7ft, and 8ft Widths)**



# Table of Contents

## Contents

ATTENTION: Warning Requirements .....	2
Hardware for Different Surface Applications .....	3
Parts List.....	4
Parts Included: .....	4
Parts Not Provided:.....	5
Assembly for 5ft, 6ft, 7ft, and 8ft Width Houstonian Awnings .....	6
Step 1: Count every part to make sure you have the proper amount for your specific awning width size (ft). .....	6
Step 2: Frame Assembly for 5ft, 6ft, 7ft, and 8ft Houstonians: .....	6
Step 3:Insert the Spines onto the Full Top Bar and Front Bar .....	9
Step 4: Laying out the Right, Middle, and Left Panels onto the Assembled Frame .....	10
Step 5: Input the Sheet Screws for the Panels.....	11
Step 6: Attaching the Back Bars to the Full top Bar.....	13
Step 7: Attaching the Projection Bars to the Back Bars.....	13
Step 8: Installing Middle Support to the Front Bar .....	14
Step 9: Installing the Shroud (Hood Cover) to the Surface.....	14
Step 10: Mounting the Back Bars and Middle Support of the Assembled Awning to the Surface.....	16
Step 11:Your Houstonian is complete! .....	17
WARRANTY .....	18
RETURNS & DAMAGES.....	20

## ATTENTION: Warning Requirements

- ⚠ **WARNING:** Adult Assembly Required
- ⚠ **WARNING:** Assembly Kit Contains Parts with Sharp Points, Sharp Edges, and Small Parts That Can Present Choking Hazards to Children.
- ⚠ **WARNING:** Components Are Packed in Plastic Bags That are a Suffocation Hazard.

**NOTE:** Please inspect the parts for damage during shipping and/or for any missing items. If you suspect that there may be damage or a shortage, contact us and we will send replacement parts if needed. At this time, visualize how the components fit together and make sure that you have identified the various parts.













## Hardware for Different Surface Applications











Before you begin the assembly, there is a variety of building wall surfaces; Awntech does not supply the hardware to install your awning. You will need to purchase installation hardware at your local hardware store. We have advised you on **different surface applications below**:

Concrete Block Walls	<ul style="list-style-type: none"> <li>• (1) 1/2" masonry bit with a 3/8" shank</li> <li>• (4-5) 5/16" X 3" Masonry anchor bolts             <ul style="list-style-type: none"> <li>• 9/16" socket</li> </ul> </li> </ul>
Metal Buildings	<ul style="list-style-type: none"> <li>• 2X6X8 #2YP Cut into 12" blocks for the back side of the metal             <ul style="list-style-type: none"> <li>• (4-5) 5/16"x4" lag bolts</li> <li>• (4-5) 5/16" washer and 3/8" drill bit</li> </ul> </li> <li>• Bolt through the washer, the bracket and the metal into wood blocks behind the metal.</li> </ul>
Any Type of Siding	<ul style="list-style-type: none"> <li>• (4-5) 1/4"x4" toggle bolts             <ul style="list-style-type: none"> <li>• (4-5) 1/4" washers</li> <li>• Flat head screwdriver</li> </ul> </li> <li>• 1/2" drill bit (or if you hit a stud)             <ul style="list-style-type: none"> <li>• (5-8) 5/16" X 4" lag bolts</li> <li>• (4-5) 5/16" washers</li> </ul> </li> <li>• (1) 3/16" drill bit and a 9/16" socket</li> </ul>
Concrete, Brick, or Stone	<ul style="list-style-type: none"> <li>• 1/2" Masonry bit with a 3/8" shank</li> <li>• (4-5) 5/16"x3" masonry anchor bolts             <ul style="list-style-type: none"> <li>• (4) 5/16" X 4" bushings</li> <li>• 9/16" sockets</li> </ul> </li> <li>• You will also need a roll of weather stripping.</li> </ul>
Stucco	<ul style="list-style-type: none"> <li>• (4-5) 1/4" X 4" toggle bolts             <ul style="list-style-type: none"> <li>• (4-5) 1/4" washers</li> <li>• flat head screwdriver</li> </ul> </li> <li>• 1/2" drill bit (or if you hit a stud)             <ul style="list-style-type: none"> <li>• (4) 5/16" X 4" lag bolts</li> <li>• (4-5) 5/16" washers                 <ul style="list-style-type: none"> <li>• 3/16" drill bit</li> <li>• 9/16" socket</li> </ul> </li> </ul> </li> </ul>

## Parts List

### Parts Included:

Part Image	Part Name	Part #	5ft	6ft	7ft	8ft
	Black Nylon "L" Connectors	<b>a</b>	4	4	4	4
	Left Top Bar for 5ft, 6ft, 7ft, & 8ft	<b>b1</b>	1	1	1	1
	Right Top Bar for 5ft, 6ft, 7ft, & 8ft	<b>b2</b>	1	1	1	1
	Left Front Bar (with hooks) for 5ft, 6ft, 7ft, 8ft	<b>c1</b>	1	1	1	1
	Right Front Bar (with hooks) for 5ft, 6ft, 7ft, 8ft	<b>c2</b>	1	1	1	1
	Left Frame	<b>d1</b>	1	1	1	1
	RightFrame	<b>d2</b>	1	1	1	1
	Spines	<b>e</b>	5	6	7	8
	Sheet Screws	<b>f</b>	44	48	52	58
	Left Panel	<b>g</b>	1	1	1	1
	Middle Panel	<b>h</b>	4	5	6	7
	Right Panel	<b>i</b>	1	1	1	1

	Left Back Bars	<b>j1</b>	1	1	1	1
	Right Back Bars	<b>j2</b>	1	1	1	1
	Left Projection Bars	<b>k1</b>	1	1	1	1
	Right Projection Bars	<b>k2</b>	1	1	1	1
	Bolt for Projection and Back Bars	<b>l</b>	7	7	7	7
	Nut for Projection and Back Bars	<b>m</b>	7	7	7	7
	Left Shroud (Hood Cover) for 5ft, 6ft, 7ft, & 8ft	<b>n1</b>	1	1	1	1
	Right Shroud (Hood Cover) for 5ft, 6ft, 7ft, & 8ft	<b>n2</b>	1	1	1	1
	Aluminum Insert for Awnings Sizes 5ft, 6ft, 7ft, & 8ft	<b>p</b>	2	2	2	2
	Middle Support for Awnings Sizes 5ft, 6ft, 7ft, & 8ft	<b>q</b>	1	1	1	1

**Parts Not Provided:**

Part Image	Part Name	Part #	5ft	6ft	7ft	8ft
	M8 Anchor or M6 Anchor (Depending on surface)	<b>o</b>	6	6	7	8

## Assembly for 5ft, 6ft, 7ft, and 8ft Width Houstonian Awnings

**Step 1: Count every part to make sure you have the proper amount for your specific awning width size (ft).**

**Step 2: Frame Assembly for 5ft, 6ft, 7ft, and 8ft Houstonians:**

**Parts you will need:** 4-(a) Black Nylon “L” Connectors, 1-(b1) Left Top Bar, 1-(b2) Right Top Bar, 1 -(c1) Left Front Bar (with Hook Extenders), 1-(c2) Right Front Bar (with Hook Extenders), 2-(p) Aluminum Inserts, 12-(f) Sheet Screws, 1- Rubber Mallet/Hammer, 1- Power Drill

- a) Lay out the frame parts to where the (b1) Left Top Bar, 1-(p) Aluminum Insert, and (b2) Right Top Bar are parallel to the (c1) Left Front Bar (with Hook Extenders), 1-(p) Aluminum Insert, and (c2) Right Front Bar (with Hook Extenders). **Refer to the figure A1.**

**Figure A1: Frame Layout for widths 5ft, 6ft, 7ft, and 8ft**

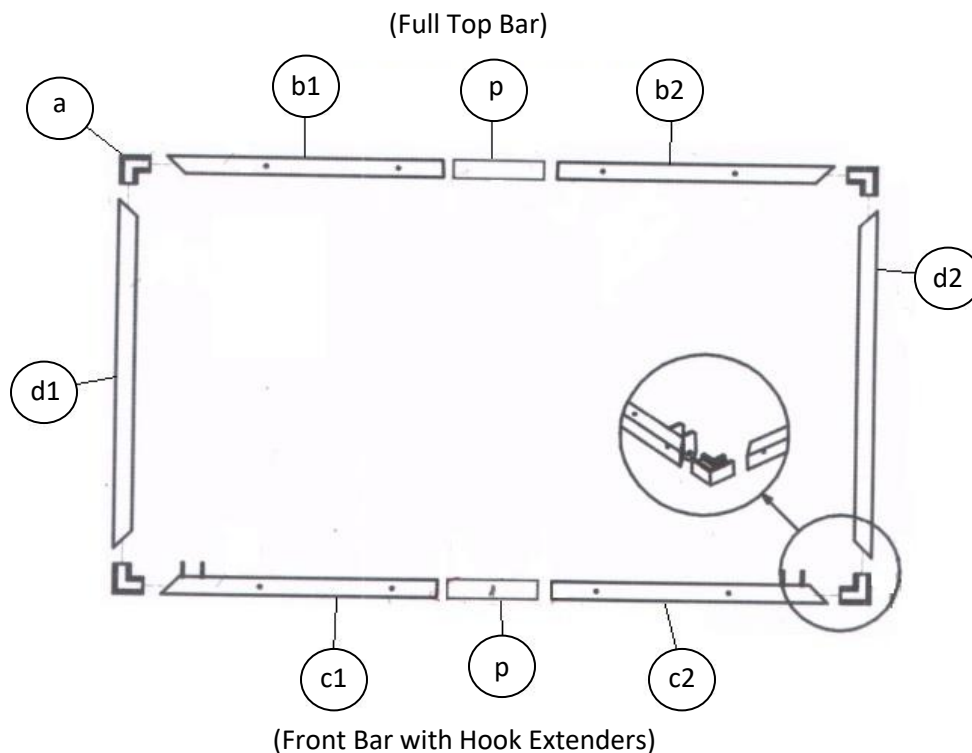

- b) Make sure the curves of the hooks on the (c1) Left Front Bar (With Hook) and (c2) Right Front Bar (With Hook) facing downwards. Make sure the extenders of the (b1) Left Top Bar and (b2) Right Top Bar are facing downwards. **Refer to the figure A2.**

**Figure A2: (b1) and (b2) Assembled Together Full Top Bar Facing Downwards**



- c) Connect the (b1) Right Top Bar and (b2) Left Top Bar together by inserting one of the (p) Aluminum Inserts in with a Rubber Mallet/hammer. Hammer the (p) Aluminum insert in the flat hollow opening of the (b1) Right Top Bar up until the black line marker in the middle of the (p) Aluminum Insert reaches the edge of the hollow opening of the (b1) Right Top Bar. Connect the flat hollow opening of the (b2) Left Top Bar to the other half of the same (p) Aluminum Insert.
- Refer to the figure A3.**

**Figure A3: Connecting the Right and Left Top Bar**

**Step 1:**

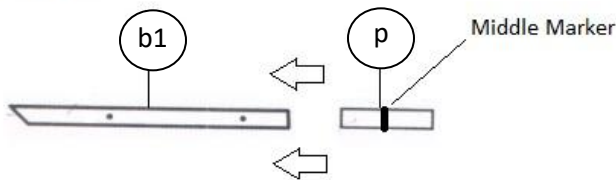

**Step 2:**

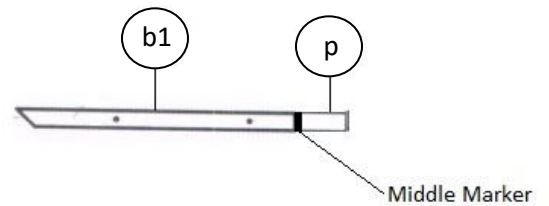

**Step 3:**

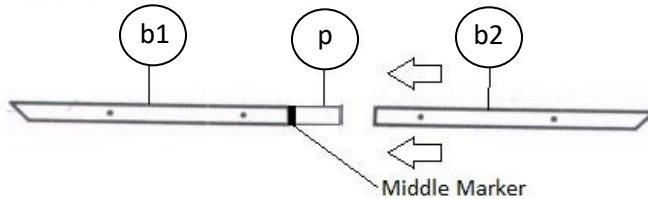

**Step 4:**

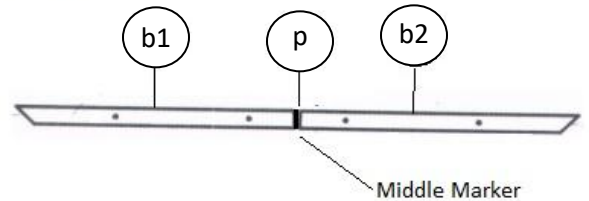

- d) Connect the (d1) Left Front Bar and (d2) Right Front Bar together by inserting one of the (p) Aluminum Inserts in with a Rubber Mallet/hammer. Hammer the (p) Aluminum insert in the flat hollow opening of the (d1) Left Front Bar up until the black line marker in the middle of the (p) Aluminum Insert reaches the edge of the hollow opening of the (d1) Left Front Bar. Connect the flat hollow opening of the (d2) Right Front Bar to the other half of the same (p) Aluminum Insert.
- Refer to the figure A4.**

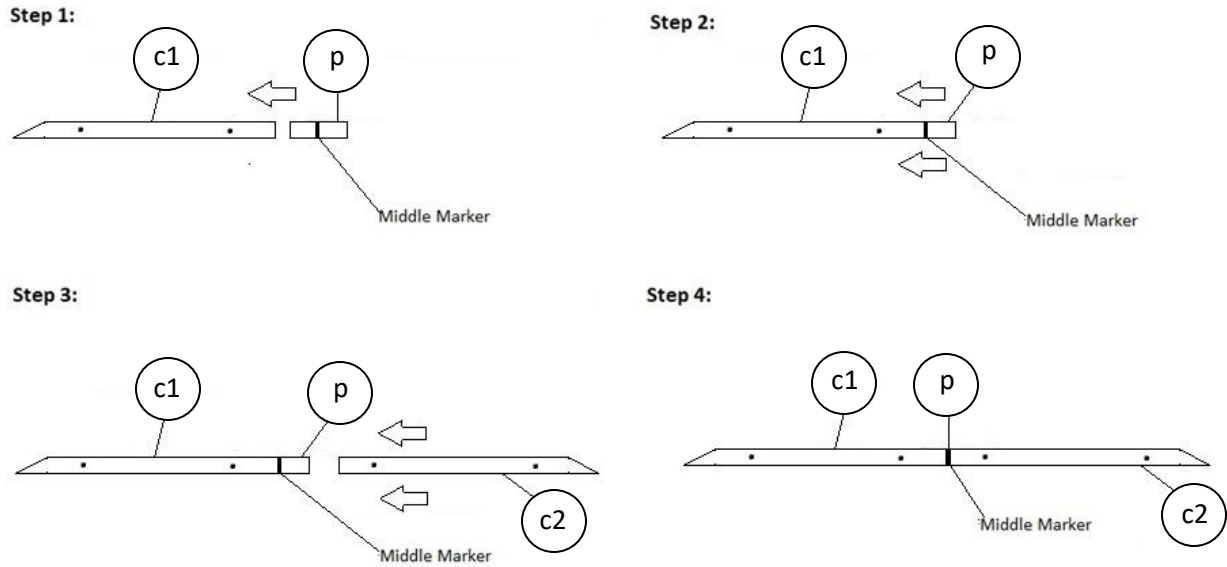

e) Connect the (a) Black Nylon “L” Connectors with a rubber mallet/hammer to each frame part. **Refer to the figure A5.**

**Figure A5: Connecting the Top Bar, Front Bar, and Frames with Black Nylon “L” Connectors**

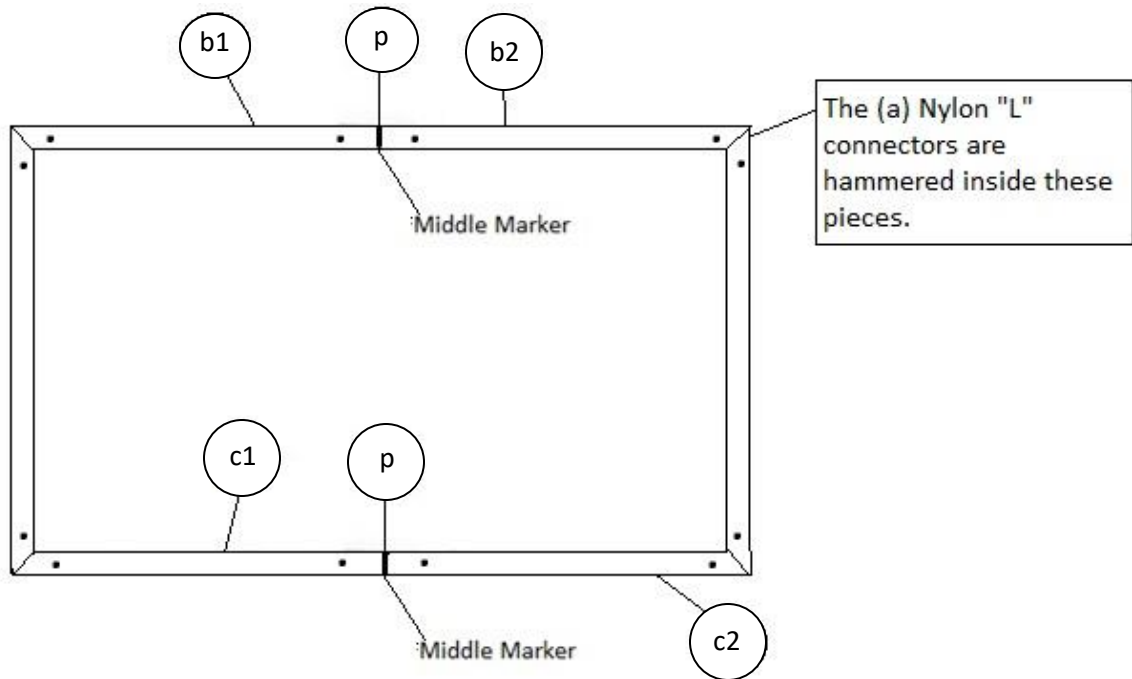

a) Use the Power Drill to input the (f) Sheet Screws into each hole. **Refer to the figure A6.**

**Parts you will need for a 5ft, 6ft, 7FT, 8FT:** 24-(f) Sheet Screws, 1 Drill

**Figure A6: Drill in the Sheet Screws (All of these holes are facing outward)**

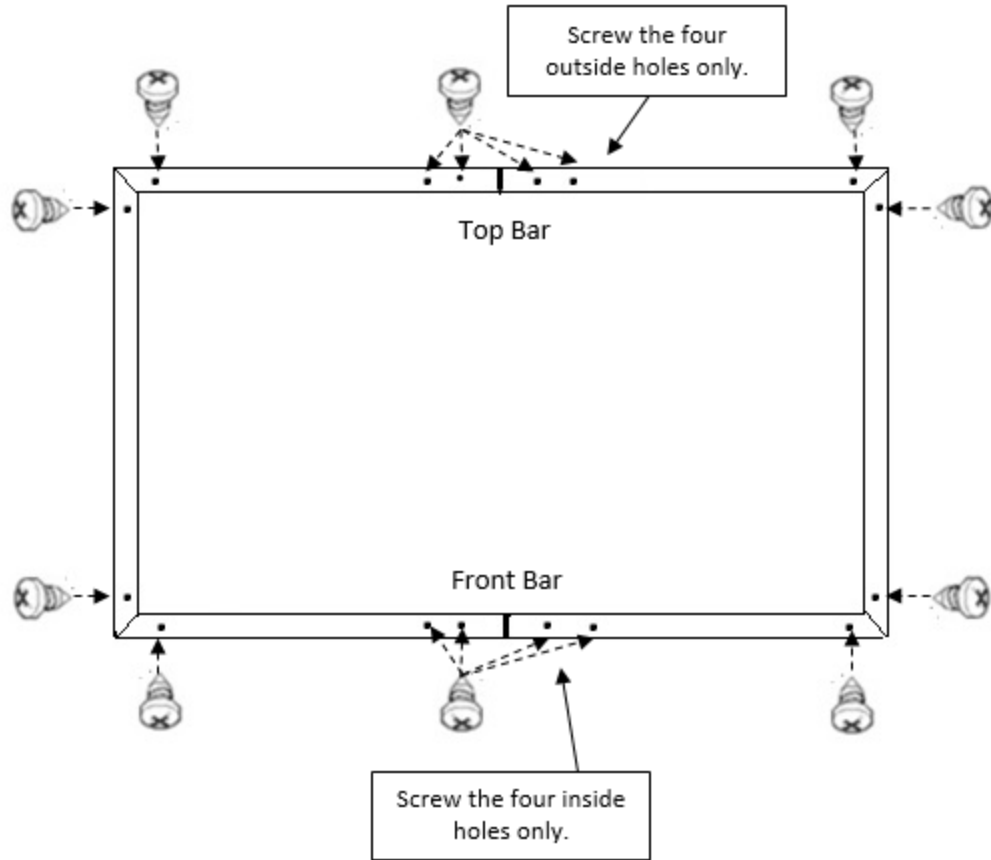

### Step 3: Insert the Spines onto the Full Top Bar and Front Bar

**Parts you will need for a 5ft:** 5-(e) Spines, 10-(f) Sheet Screws, 1 Drill

**Parts you will need for a 6ft:** 6-(e) Spines, 12-(f) Sheet Screws, 1 Drill

**Parts you will need for a 7ft:** 7-(e) Spines, 14-(f) Sheet Screws, 1 Drill

**Parts you will need for an 8ft:** 8-(e) Spines, 16-(f) Sheet Screws, 1 Drill

- a) Using a drill and (f) sheet screws, connect the ends of each (e) Spine to the pre drilled holes on the attached (b1) Left Top Bar and (b2) Right Top Bar and the attached (c1) Left Front Bar and (d2) Right Front Bar (with hook extenders). The larger holes on the (e) Spines will connect to the attached (c1) Left Front Bar (with Hook Extenders) and (c2) Right Front Bar (with hook extenders). Refer to the two figures below.

**Figure B1:** Inserting Spines (Houstonian 5ft Example)

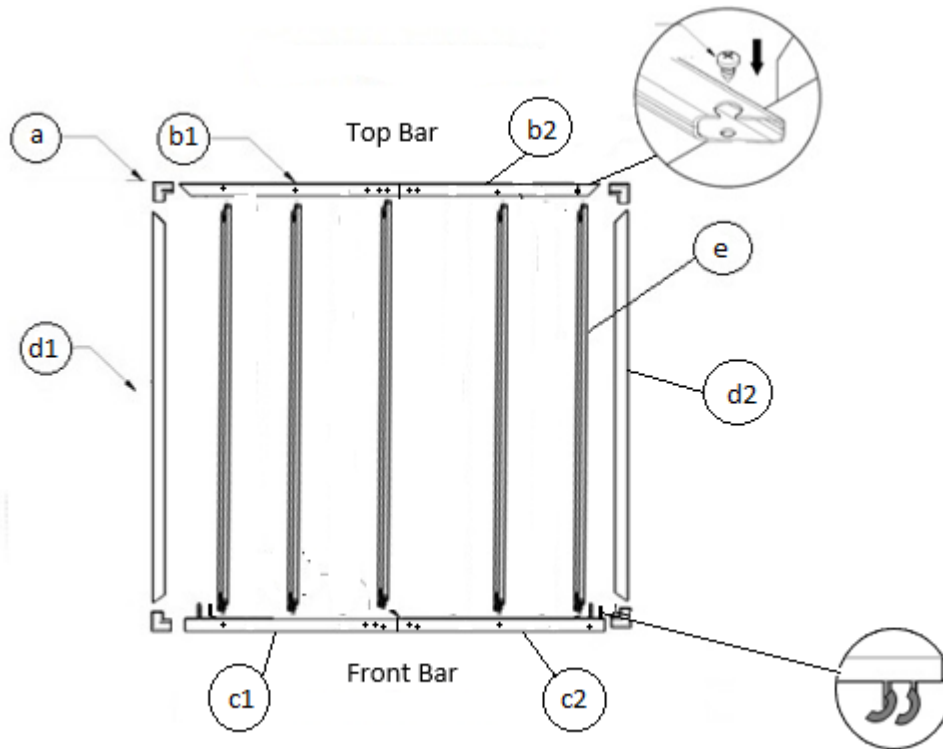

#### Step 4: Laying out the Right, Middle, and Left Panels onto the Assembled Frame

**Parts you will need for a 5ft:** 1-(g) Left Panel, 4-(h) Middle Panels, 1-(i) Right Panel, 18 (f) Sheet Screws, 1- Drill

**Parts you will need for a 6ft:** 1-(g) Left Panel, 5-(h) Middle Panels, 1-(i) Right Panel, 20-(f) Sheet Screws, 1-Drill

**Parts you will need for a 7ft:** 1-(g) Left Panel, 6-(h) Middle Panels, 1-(i) Right Panel, 22-(f) Sheet Screws, 1-Drill

**Parts you will need for an 8ft:** 1-(g) Left Panel, 7-(h) Middle Panels, 1-(i) Right Panel, 24-(f) Sheet Screws, 1-Drill

- a) When assembling the panels, start with the assembled (c1) and (c2) Front Bars closest to you. You will lay the panels down vertically so that the bottom of the panel lies on top of the (c1) and (c2) Front Bars and the top of the panel lies on top of the (b1) and (b2) Full Top Bars.
- b) Begin with the (g) Left Panel; the starting panel. Make sure the left side of the (g) panel is the side/lip hanging down over the (d1) Left Side Frame. This will cover the left side of the awning frame when staring at the awning face forward. *Refer to the figures C1 and C2 below.*
- c) Apply the (h) Middle Panels as shown in the figures below. The panel's seams, located on the left side of each (h) Middle Panel will be set on top of the right side of the panel that was set before it and interlock with each other.

- d) Finish assembling the panels with the (i) Right Panel. Make sure the right side of the (i) panel is the side/lip hanging down over the (d2) Right Side Frame. This will cover the right side of the awning frame when staring at the awning face forward.

**Figure C1:**Layout of Panels for Houstonian 4ft Example

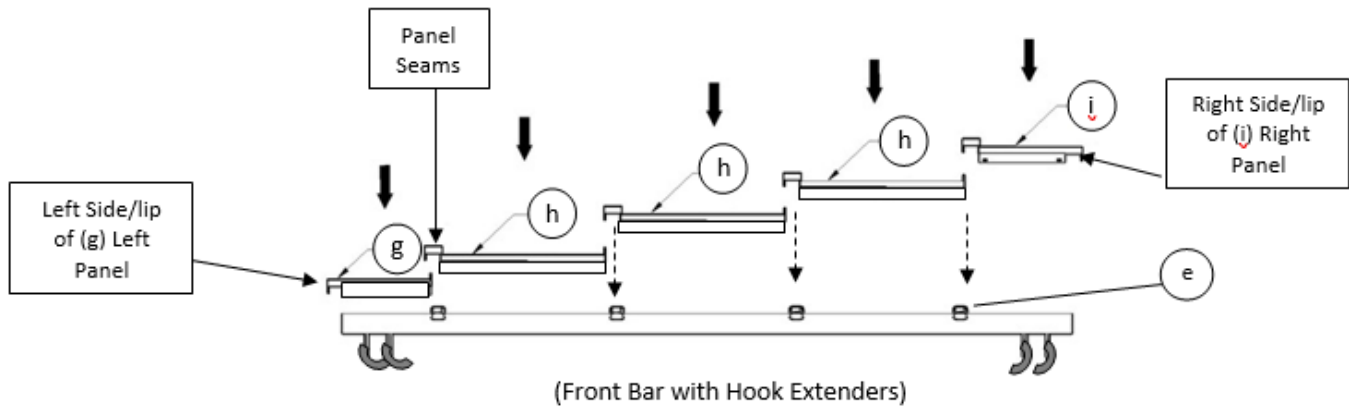

### Step 5: Input the Sheet Screws for the Panels

**Parts you will need for a 5ft:** 18-(f) Sheet Screws, 1- Drill

**Parts you will need for a 6ft:** 20-(f) Sheet Screws, 1- Drill

**Parts you will need for a 7ft:** 22-(f) Sheet Screws, 1- Drill

**Parts you will need for an 8ft:** 24-(f) Sheet Screws, 1- Drill

- Now that the panels are in place, you will need to insert the (f) Sheet Screws into the holes and drill them in. The holes are available on the tops and bottoms of the panel's edges.
- First, insert and drill the (f) Sheet Screws into the attached (c1) and (c2) Front Bars first. **Refer to figure D1 below.**
- Second, insert and drill the (f) Sheet Screws into the attached (b1) and (b2) Full Top Bars. **Refer to figure D2 below.**
- Third, insert and drill the (f) Sheet Screws into the (d1) Left and (d2) Right Frames

**Figure D1:** Input (f) Sheet Screws into the (c1) and (c2) Front Bars

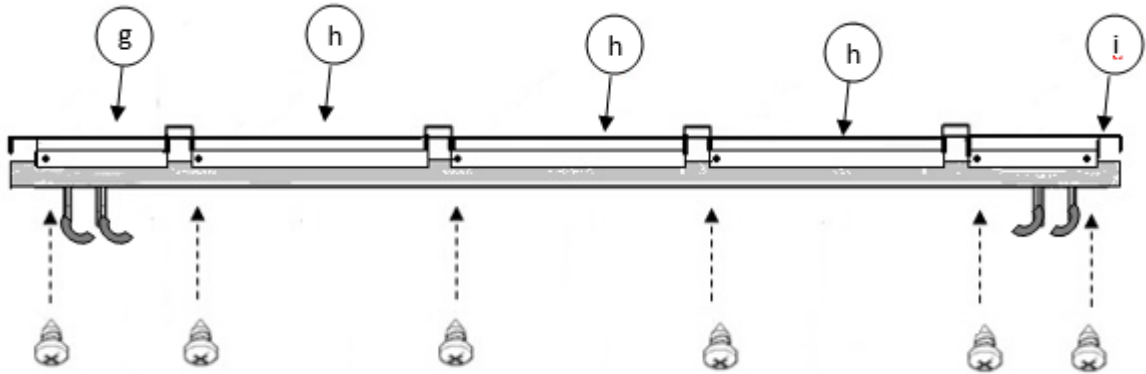

**Figure D2:** Input (f) Sheet Screws into the (b1) and (b2) Full Top Bar

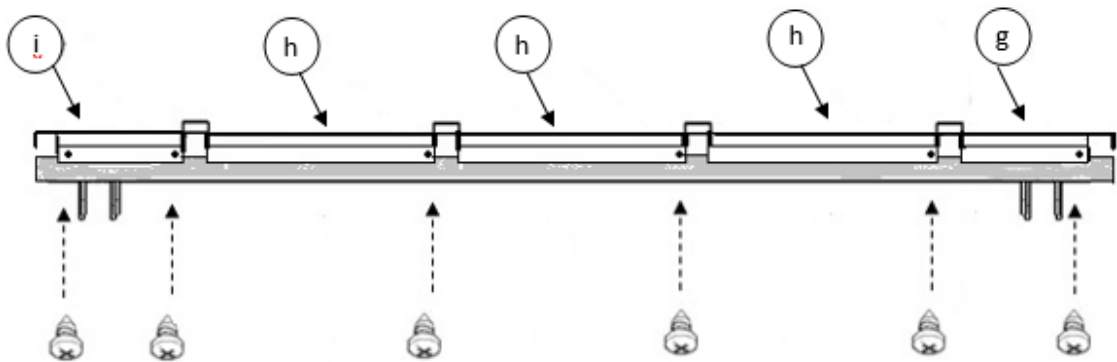

**Figure D3:** Input Sheet Screws into the Left Frame and Right Frame

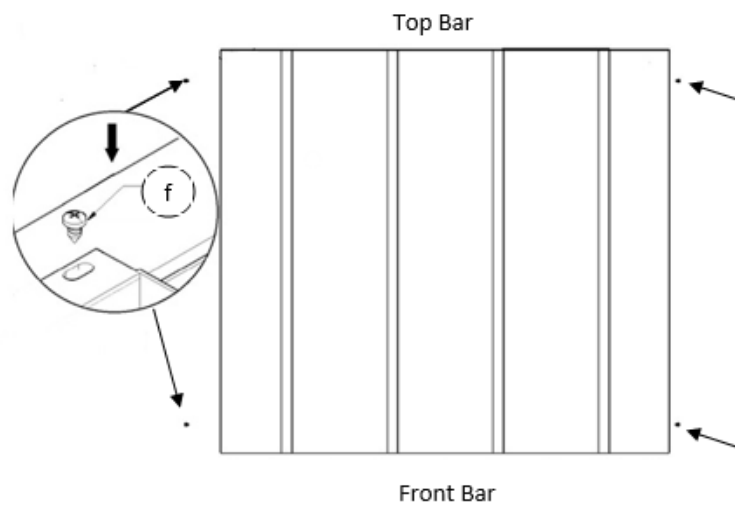

## Step 6: Attaching the Back Bars to the Full top Bar

**Parts you will need for a 5ft:** 1 Set of-(j1) Left and (j2) Right Back Bars, 2-(p) Bolts, 2-(q) Nuts

**Parts you will need for a 6ft:** 1 Set of-(j1) Left and (j2) Right Back Bars, 2-(p) Bolts, 2-(q) Nuts

**Parts you will need for a 7ft:** 1 Set of-(j1) Left and (j2) Right Back Bars, 2-(p) Bolts, 2-(q) Nuts

**Parts you will need for a 8ft:** 1 Set of-(j1) Left and (j2) Right Back Bars, 2-(p) Bolts, 2-(q) Nuts

Be sure that the tabs on the (j1) Left Back Bar and (j2) Right Back Bar are facing inward. **Refer to figure E1.**

**Figure E1:** Attaching the (j1) Left Back Bar and (j2) Right Back Bar

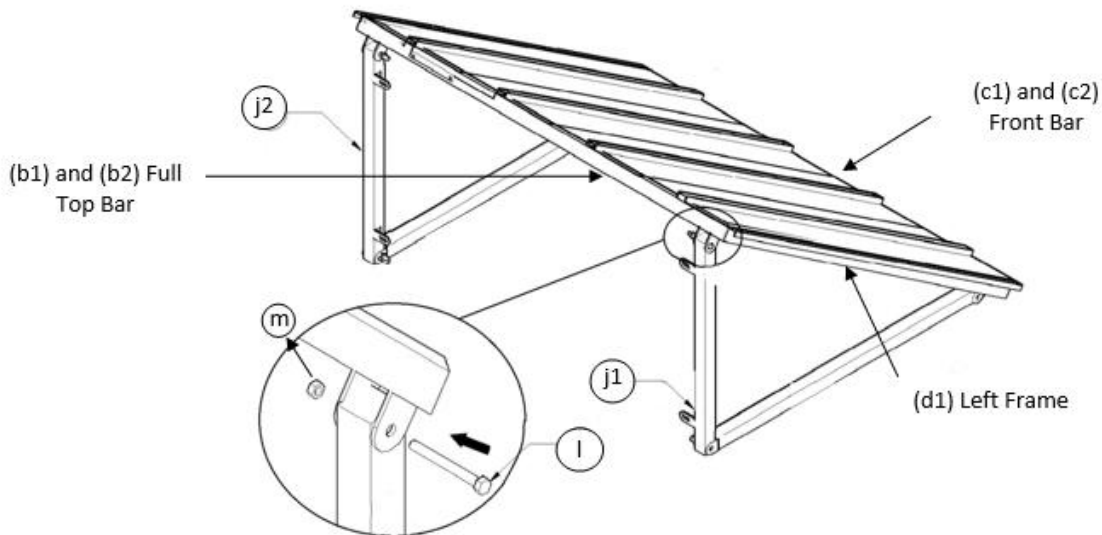

## Step 7: Attaching the Projection Bars to the Back Bars

**Parts you will need for a 5ft:** 1-(k1) Left Projection Bar and 1-(k2) Right Projection Bar, 4-(l) Bolts, 4-(m) Nuts

**Parts you will need for a 6ft:** 1-(k1) Left Projection Bar and 1-(k2) Right Projection Bar, 4-(l) Bolts, 4-(m) Nuts

**Parts you will need for a 7ft:** 1-(k1) Left Projection Bar and 1-(k2) Right Projection Bar, 4-(l) Bolts, 4-(m) Nuts

**Parts you will need for a 8ft:** 1-(k1) Left Projection Bar and 1-(k2) Right Projection Bar, 4-(l) Bolts, 4-(m) Nuts

**Figure F1:** Attaching the (k1) Left Projection Bar and (k2) Right Projection Bar to the (j1) Left Back Bar and (j2) Right Back Bar

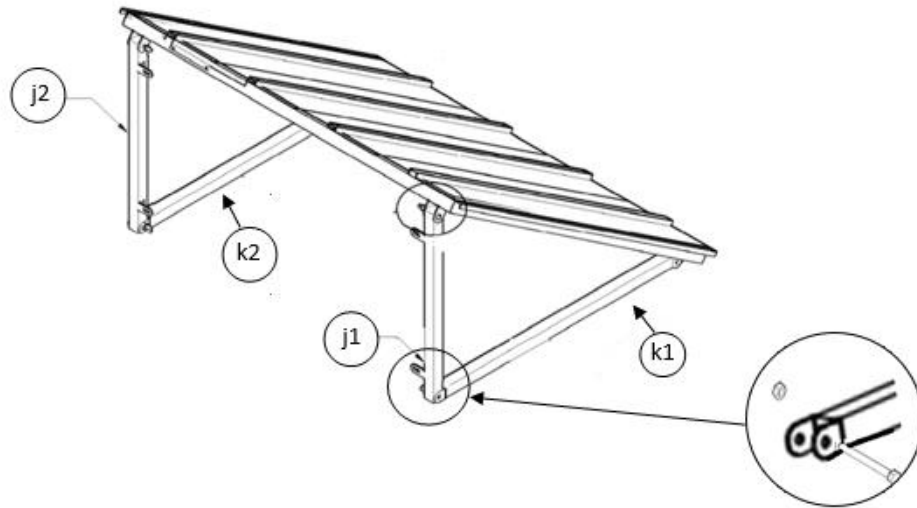

**Figure F2:** Attaching the Projection Bars to Front Bar

### Step 8: Installing Middle Support to the Front Bar

**Parts you will need for a 5ft:** 1-(q) Middle Support, 4-(f) Sheet Screws, Drill

**Parts you will need for a 6ft:** 1-(q) Middle Support, 4-(f) Sheet Screws, Drill

**Parts you will need for a 7ft:** 1-(q) Middle Support, 4-(f) Sheet Screws, Drill

**Parts you will need for an 8ft:** 1-(q) Middle Support, 4-(f) Sheet Screws, Drill

- Take the adjustable end of the (q) middle support and align the holes with the holes in the middle of the back side of the assembled (c1) and (c2) front bar.
- Apply 4 (f) sheet screws to the holes

### Step 9: Installing the Shroud (Hood Cover) to the Surface

**Parts you will need for a 5ft:** 1 -(n1) Left Shroud (Hood Cover), 1 -(n2) Right Shroud (Hood Cover), 4-(o) M8 or M6 Anchors, 4-(m) Nuts, Drill, Level, Measuring Tape

**Parts you will need for a 6ft:** 1 -(n1) Left Shroud (Hood Cover), 1 -(n2) Right Shroud (Hood Cover), 4-(o) M8 or M6 Anchors, 4-(m) Nuts, Drill, Level, Measuring Tape

**Parts you will need for a 7ft:** 1 -(n1) Left Shroud (Hood Cover), 1 -(n2) Right Shroud (Hood Cover), 4-(o) M8 or M6 Anchors, 4-(m) Nuts, Drill, Level, Measuring Tape

**Parts you will need for an 8ft:** 1 -(n1) Left Shroud (Hood Cover), 1 -(n2) Right Shroud (Hood Cover), 4-(o) M8 or M6 Anchors, 4-(m) Nuts, Drill, Level, Measuring Tape

- a) Carefully measure the distance between each mounting opening on the (n) Shroud (Hood Cover) with measuring tape. The (n1) Left Shroud (Hood Cover) should have an extension added to it. Make sure when you are installing the (n1) and (n2) shrouds, that the one shroud with the extension overlaps the other shroud.
- b) Still using the measuring tape, mark the same measurements of the mounting holes you gathered from the combined (n1) and (n2) Shroud (Hood Cover) onto on the desired mounting surface with chalk. Use a level as needed.
- c) Drill pilot holes onto the specific markers. **Refer to figure G1.**
- d) Line up the mounting holes with the holes on the (n1) and (n2) Shroud (Hood Cover). Put the (o) anchors through each hole of the (n1) and (n2) Shroud (Hood Cover) and into the wall and make sure they are snug.

**Figure G1:** *Drill Pilot Holes into the Mounting Surface*

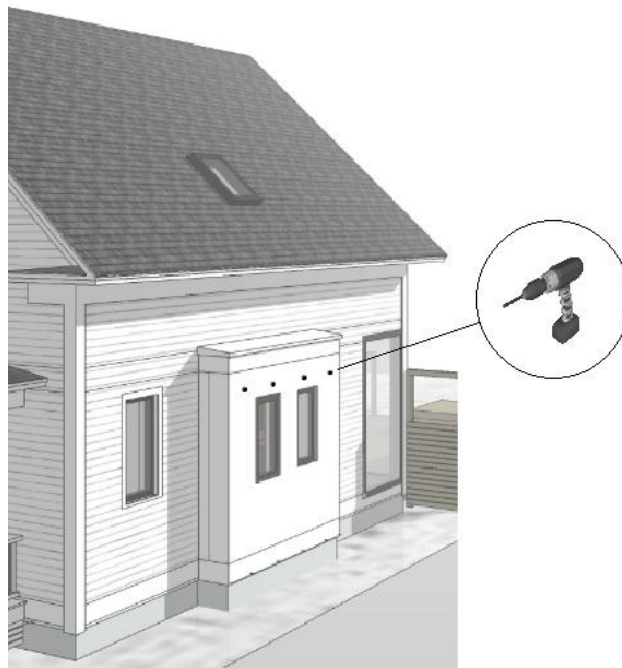

**Figure G2:** *Installing (n1) and (n2) Shroud (Hood Cover) to the Pilot Holes*

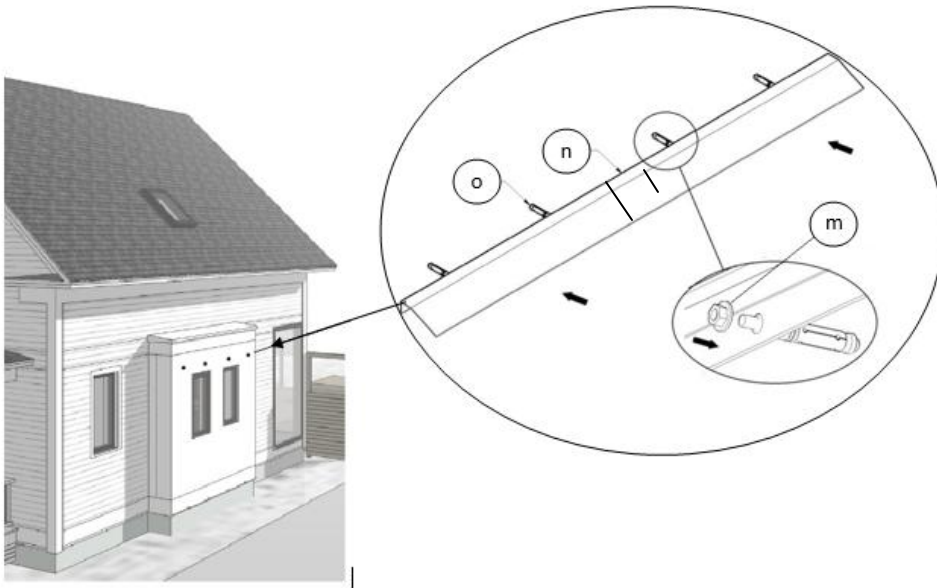

## Step 10: Mounting the Back Bars and Middle Support of the Assembled Awning to the Surface

**Parts you will need for a 5ft:** 6-(o) M8 or M6 Anchors, 6-(m) nuts, Drill

**Parts you will need for a 6ft:** 6-(o) M8 or M6 Anchors, 6-(m) nuts, Drill

**Parts you will need for a 7ft:** 6-(o) M8 or M6 Anchors, 6-(m) nuts, Drill

**Parts you will need for an 8ft:** 6-(o) M8 or M6 Anchors, 6-(m) nuts, Drill

- Drill the pilot holes into the desired surface. Put the (o) anchors into the wall and make sure they are snug.
- Mount the tabs of the (j1) Left Back Bar and the (j2) Right Back Bar onto each (o) anchor. Make sure the anchor is in between the back bar mounting opening.
- The awning should fit under the combined and assembled (n1) and (n2) Shroud (Hood Cover)
- Place each (m) Nut on the tip of each (o) anchor and tighten accordingly. **Please refer to Figures H1.**
- Once the back bars are in place, install the flat end of the (q) middle support to the surface by inserting the anchors.

**Figure H1:** Mounting the Awning onto the wall

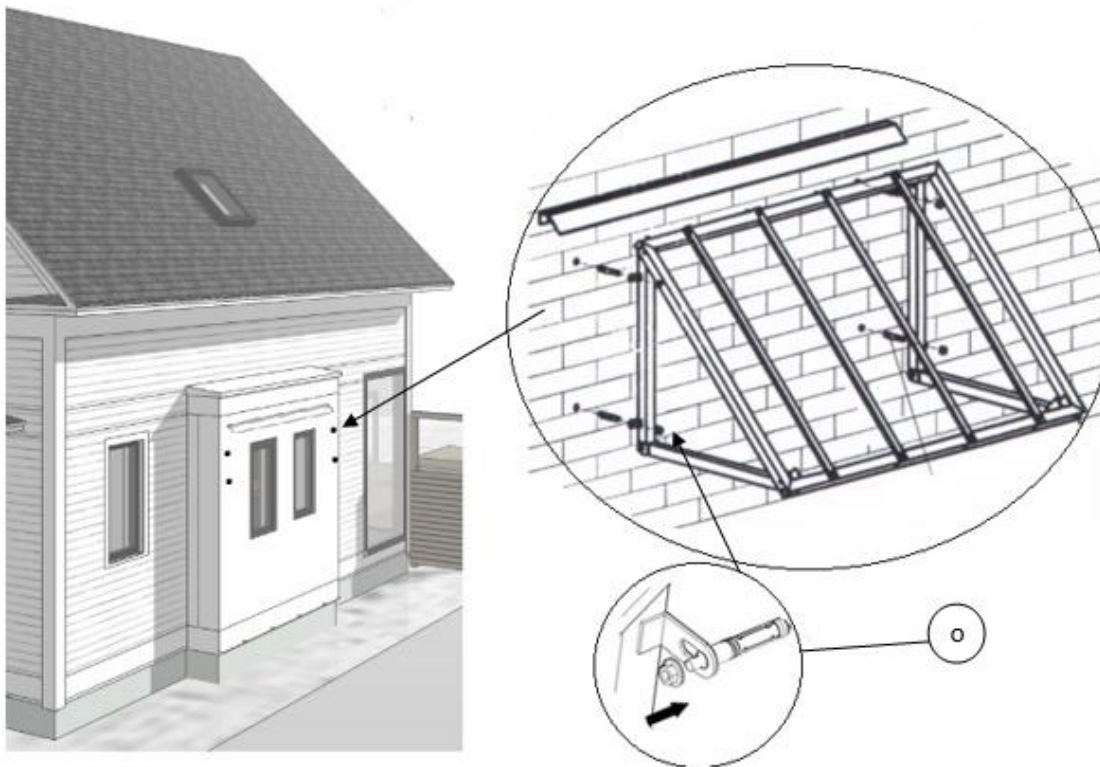

**Step 11: Your Houstonian is complete!**

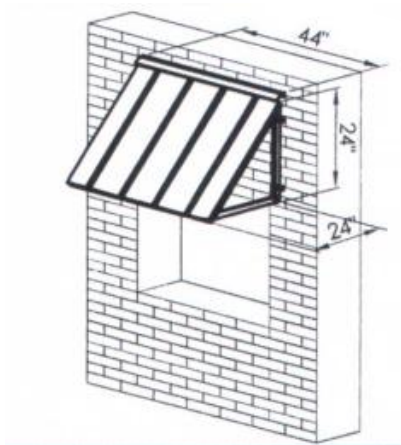

## WARRANTY

### 5-Year Manufacturer's Limited Warranty

Obtaining necessary permits is the sole responsibility of the purchaser.

Purchaser/customer agrees he/she/company will NOT hold Awntech liable for improper installation, maintenance and repairs.

**A. WARRANTY:** 5 Year Limited Manufacturer's Warranty (Prorated by the month)

### **B. WHO GIVES THIS WARRANTY**

### **C. WHO IS ENTITLED TO THIS WARRANTY?**

This Warranty applies only to the original purchaser who paid for the product and may not be assigned or transferred to subsequent owners. This Warranty applies only to products purchased and installed in the United States.

### **D. WHAT ARE THE RESPONSIBILITIES OF AWNTECH UNDER THIS WARRANTY?**

Subject to the terms and conditions set forth herein, Awntech Corporation will furnish replacements for parts found by Awntech Corporation to be defective in design, manufacture or assembly, under each specific component or product warranty as set forth below.

### **E. WHAT ARE THE RESPONSIBILITIES OF THE ORIGINAL PURCHASER UNDER THE WARRANTY?**

- Before any claims may be made under this Warranty, the original purchaser must have paid in full for the product covered under the Warranty, according to the terms and conditions of the pay-plan defined in the original order. IF THE PURCHASER HAS FAILED TO MAKE FULL PAYMENT, THIS WARRANTY SHALL BE NULLIFIED AND AWNTECH CORPORATION SHALL BE RELIEVED FROM ANY RESPONSIBILITY OR LIABILITY UNDER THIS WARRANTY. The purchaser agrees and acknowledges that this Warranty agreement constitutes an executor contract.
- The purchaser must use care in installation, maintenance, operation, use, and storage of the product in accordance with the instructions contained in the owner's manual. ANY FAILURE TO INSTALL, MAINTAIN, OPERATE, USE AND STORE THE PRODUCT IN ACCORDANCE WITH THE INSTRUCTIONS CONTAINED IN THE OWNER'S MANUAL WILL NULLIFY THIS WARRANTY AND RELIEVE AWNTECH CORPORATION FROM ANY RESPONSIBILITY OR LIABILITY UNDER THIS WARRANTY.
- Promptly notify Awntech Corporation of any claims.
- At Awntech's request the purchaser may be required to provide a photographs or videos (if necessary) of any defective parts. The purchaser may also be required to pay a deposit until the defective parts are returned to Awntech Corporation for inspection. The purchaser must obtain a return authorization form from Awntech Corporation's customer service department prior to the return of any merchandise and after having received such authorization, return the part or product, freight prepaid, to Awntech Corporation.

### **F. WHAT IS COVERED UNDER THIS WARRANTY?**

The following components of Awntech Beauty-Mark® models and their accessories (defined as accessories attached to the awning) are covered under this Warranty, subject to the limitations set forth below. These components have a five (5) year limited (prorated) warranty, against manufacturer's defects as outlined below:

(a) Should the purchaser promptly notify Awntech Corporation of such defects within one year (12 months) from the date of the original purchase, the defective component will be replaced at no charge to the purchaser. Awntech reserves the right to ask for the defective part to be returned and/or photos/videos of the defective part.

(b) After one year but within five years (60 months) from the date of the original purchase, a defective component will be replaced upon the purchaser's payment of 1/60th of the full retail cost of the component for each month of use prior to the claim.

### **FIXED AWNINGS – COVERED COMPONENTS**

Structural supports - all supporting components are warranted not to fail for five (5) years prorated.

Acrylic fabric - warranted for five (5) years prorated against:

- Excessive fading under normal conditions if maintained, operated, used, and stored in accordance with the instructions contained in the owner's manual.
- Mildew on acrylic fabric. Mildew will not form on the fabric itself, but may form on dirt and dust that have not been removed from it. Please see maintenance instructions for proper cleaning—outlined in owner's manual.

### **G. WHAT IS NOT COVERED UNDER THIS WARRANTY?**

- Any failure or damage of the components that results from any intentional or negligent actions by the purchaser or by any other person is not covered by this Warranty.
- It is the responsibility of the purchaser to securely fasten the awning to studs, joists, headers or other structural members. Any failure or damage that results from the awning falling from its installed position is not covered by this Warranty.
- Labor charges connected with installation of replacement parts are not covered by this Warranty.
- Freight expenses to and from Awntech Corporation are not covered by this Warranty and must be paid by the purchaser.
- Stretching of fabric or damage to any structural component caused by wind or water pooling on the fabric or any other weather is not covered by this Warranty, except for the limited warranty of the acrylic fabric as specifically set forth herein.

• **H. GENERAL PROVISIONS AND LIMITATIONS**

- The warranty granted herein is the exclusive remedy for the purchaser. Awntech Corporation makes no other warranties to the purchaser, express, statutory, implied or otherwise and all implied warranties, including without limitations, implied warranties of merchantability and fitness for a particular purpose, are hereby disclaimed.
- To the extent permitted by law, Awntech Corporation shall have no liability to the purchaser or any other person for incidental, special, consequential, indirect or similar damages of any kind or nature whatsoever, whether arising out of breach of warranty or other breach of contract, negligence or other tort, or otherwise, even if Awntech Corporation shall have been advised of the possibility or likelihood of such potential loss or damage. In no event shall Awntech Corporation be liable for loss of profits and/or wages.
- Some states do not allow limitations on how long an implied warranty lasts, or do not allow the exclusion or limitation of incidental or consequential damages, so the above limitations may not apply to you.

## RETURNS & DAMAGES

**RETURN QUALIFICATION:** You can only return a product if it is defective upon arrival. If you simply do not like the product or if you did not measure correctly, you will only be qualified for a merchandise credit and you will be required to pay for shipping the product back to Awntech in re-stockable condition. There will be a 25% restock fee applicable.

**SIZES 10' and LARGER or CUSTOM AWNINGS:** Any awnings 10' or larger or customized at Purchaser's request are considered non-returnable for either refund or exchange.

**DAMAGED MATERIAL:** Damage occasionally occurs during shipping. Scrapes dents and rips in the outer packaging that could indicate possible damage should be described to the carrier at the time of delivery. If damage to the product seems apparent, the shipment should be refused.

**FABRIC DYE-LOT AND LIGHTING VARIATION:** Fabric dyes may carry slightly from run to run. This is a normal and unavoidable. Different lighting types and lighting direction may cause the fabric you choose on the website to appear slightly different than the actual fabric does in full sunlight.