

Platform Bed



Thank you for your purchase.
If you have difficulty with assembly or find a part is missing or damaged,
please don't hesitate to contact us for solution.
Please attach your Order ID so we can assist you better.

Introduction

● Guide of Manual

Please read the following instruction carefully and use the product properly.

Please keep this manual and hand it over when you transfer the product.

This summary may not include every detailed information of all variations and considered steps. Please contact us when further information and help needed.

● Before Starting

Recommend no. of people needed for assembly: 4-5

Read each section carefully before starting. It is very important that each step is performed in the correct order. If these steps are not followed in sequence, assembly difficulties will occur.

Make sure all parts are included. Most board parts are labeled or stamped on the raw edge.

Please assemble the product according to the steps on the diagram strictly. Do not fully tighten the screws until all pieces are situated in place.

For continued use, it's suggested you regularly check the tightness of bolts and connections to ensure safety.

Work in spacious area, preferably on a carpet, near the place the unit will be

● Warning

Keep all accessories and packaging of this product away from babies, children and pets as they potentially

The units contains small parts which could be a choking hazard for small children. Children should be under adult supervision at all times or serious injury could occur.

Do not put the product in a humid environment for a long time to prevent mildew.

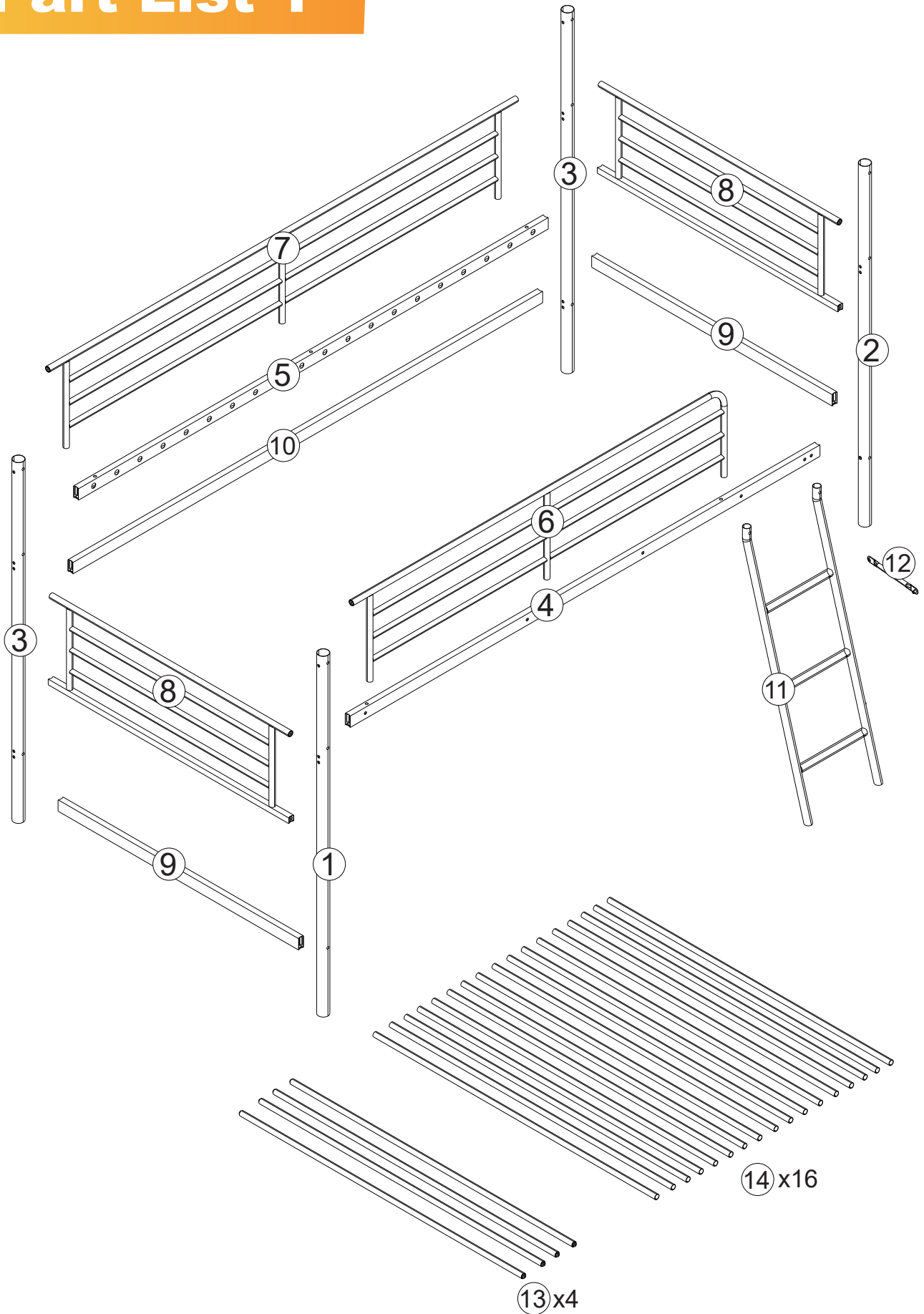

Keep the product away from sharp objects and corrosive chemicals to avoid damage.

Part List 1





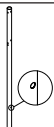
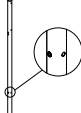
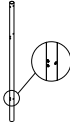
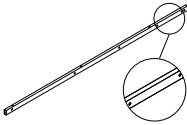
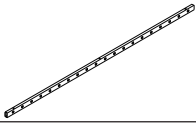
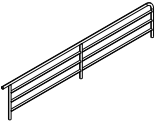
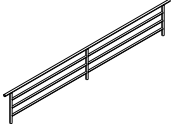
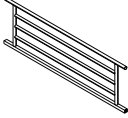
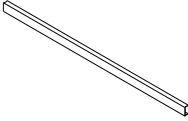
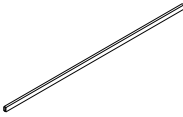
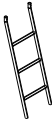



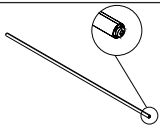
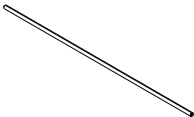

Part List 1

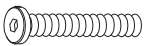
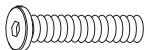

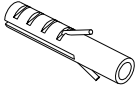
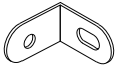
COMPONENTS

NO.	DESCRIPTION		DIMENSION	QTY
1	Post		Φ38x1270	1pcs
2	Post		Φ38x1270	1pcs
3	Post		Φ38x1270	2pcs
4	Front Rail		20x40x1910	1pcs
5	Rear Rail		20x40x1910	1pcs
6	Front Rail Guard		320x19x1524	1pcs
7	Rear Rail Guard		320x19x1904	1pcs
8	Side Rail		320x20x972	2pcs
9	Side Rail		40x20x978	2pcs
10	Rear Rail		40x20x1910	1pcs
11	Stair		310x25x961	1pcs
12	Connecting Strip		13x20x225	1pcs

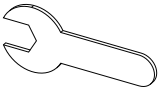
COMPONENTS

NO.	DESCRIPTION		DIMENSION	QTY
13	Bed Slat with Nut		Φ16x1028	4pcs
14	Bed Slat		Φ16x1028	16pcs
A	Screw		M6x12	10pcs+1
B	Screw		M6x60	34pcs+2
C	Screw		M8x55	1pcs
D	Washer		M8x13	27pcs+2
E1	Plastic Anchor		M6x35	2pcs
E2	Anti-tipping Kit		45x45x20	2pcs
E3	Screw		M6x35	2pcs
G	Nut		M6	2pcs
H	Allen Wrench		S4	1pcs
I	Wrench		10	1pcs

Assembly Steps



CODE	HARDWARE	QTY
B	 M6x60	6
D		6
H		1

STEP 1

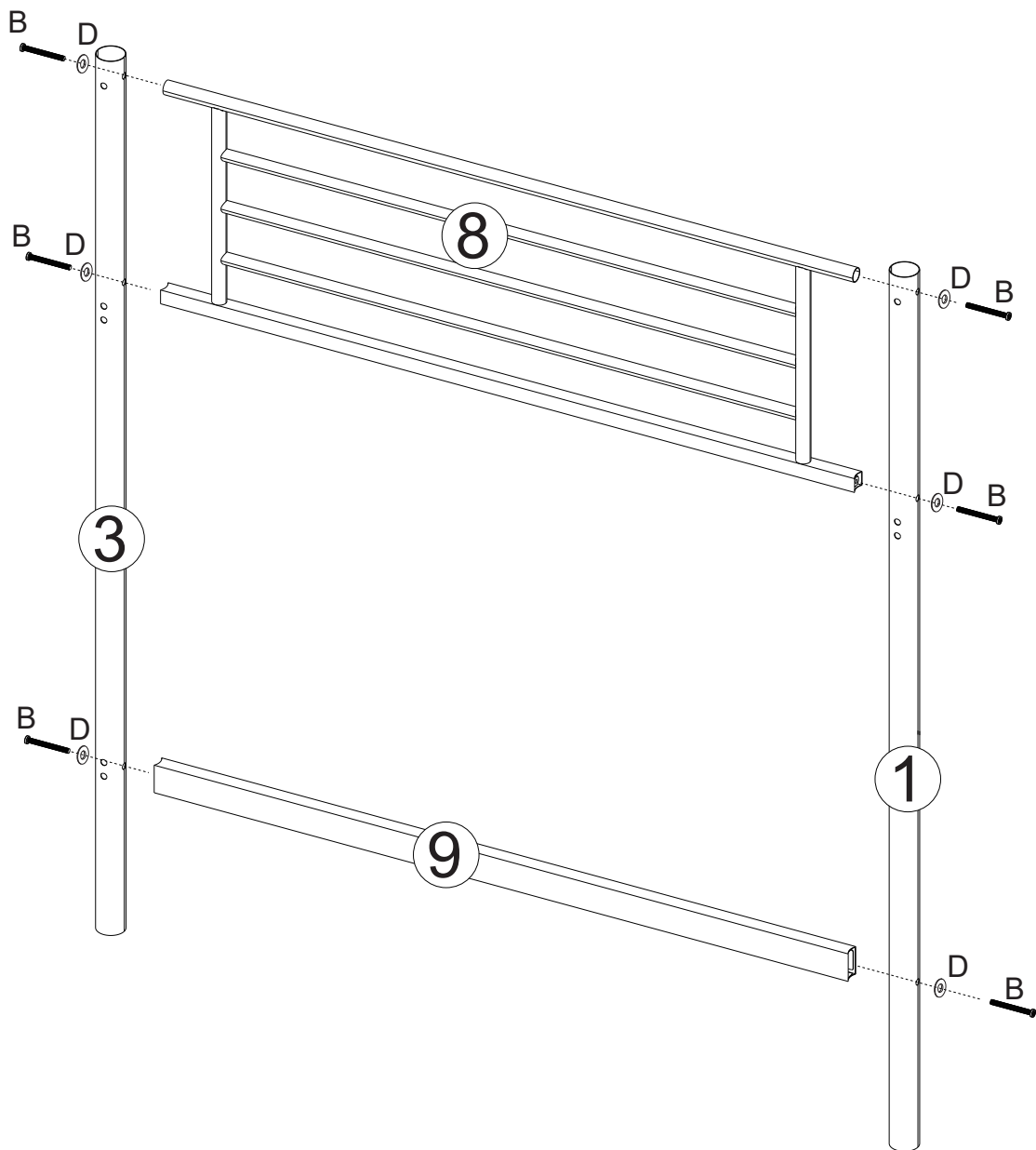
Attach side rail (8),(9) to post (1) and (3) with screw (B) and washer (D).





STEP 2

CODE	HARDWARE	QTY
B	 M6x60	6
D		6
H		1

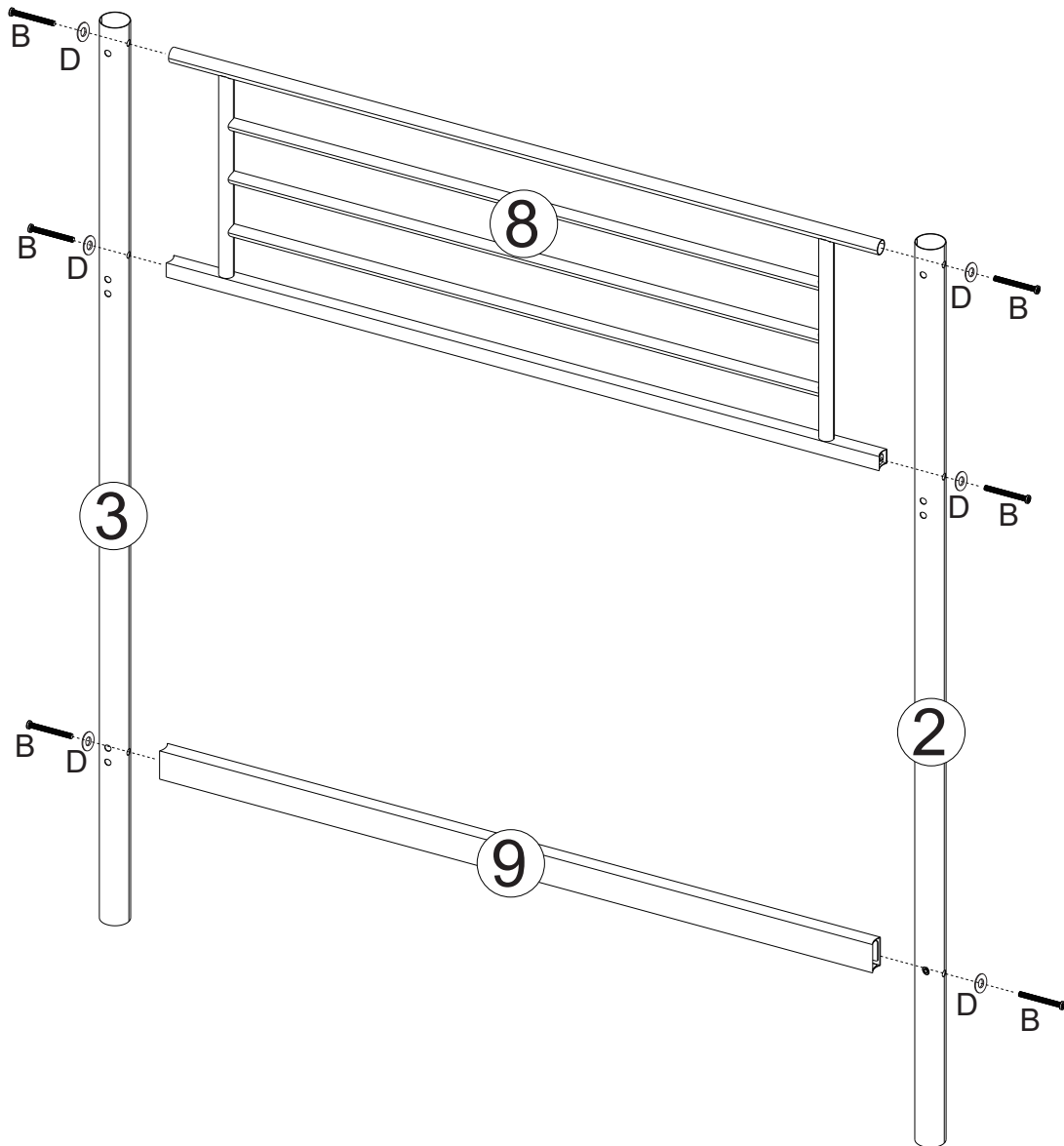
Attach side rail(8),(9) to post (2) and (3) with screw (B) and washer (D).



STEP 3



CODE	HARDWARE	QTY
A	 M6x12	8
H		1

Attach the slat (13), (14) to the top front rail(4) and rear rail (5) with screw (A).

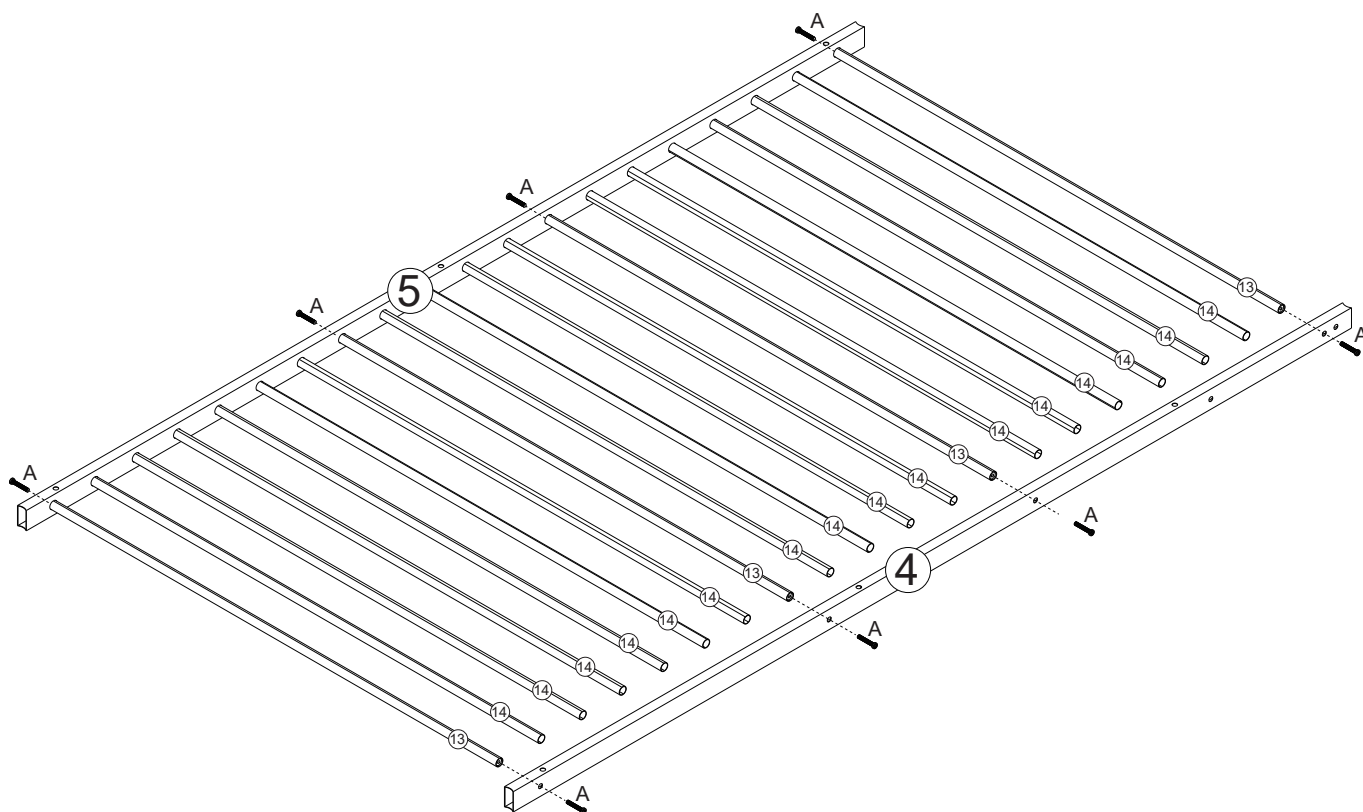
*Pay attention to install slat with nut (13) at the positions with holes.





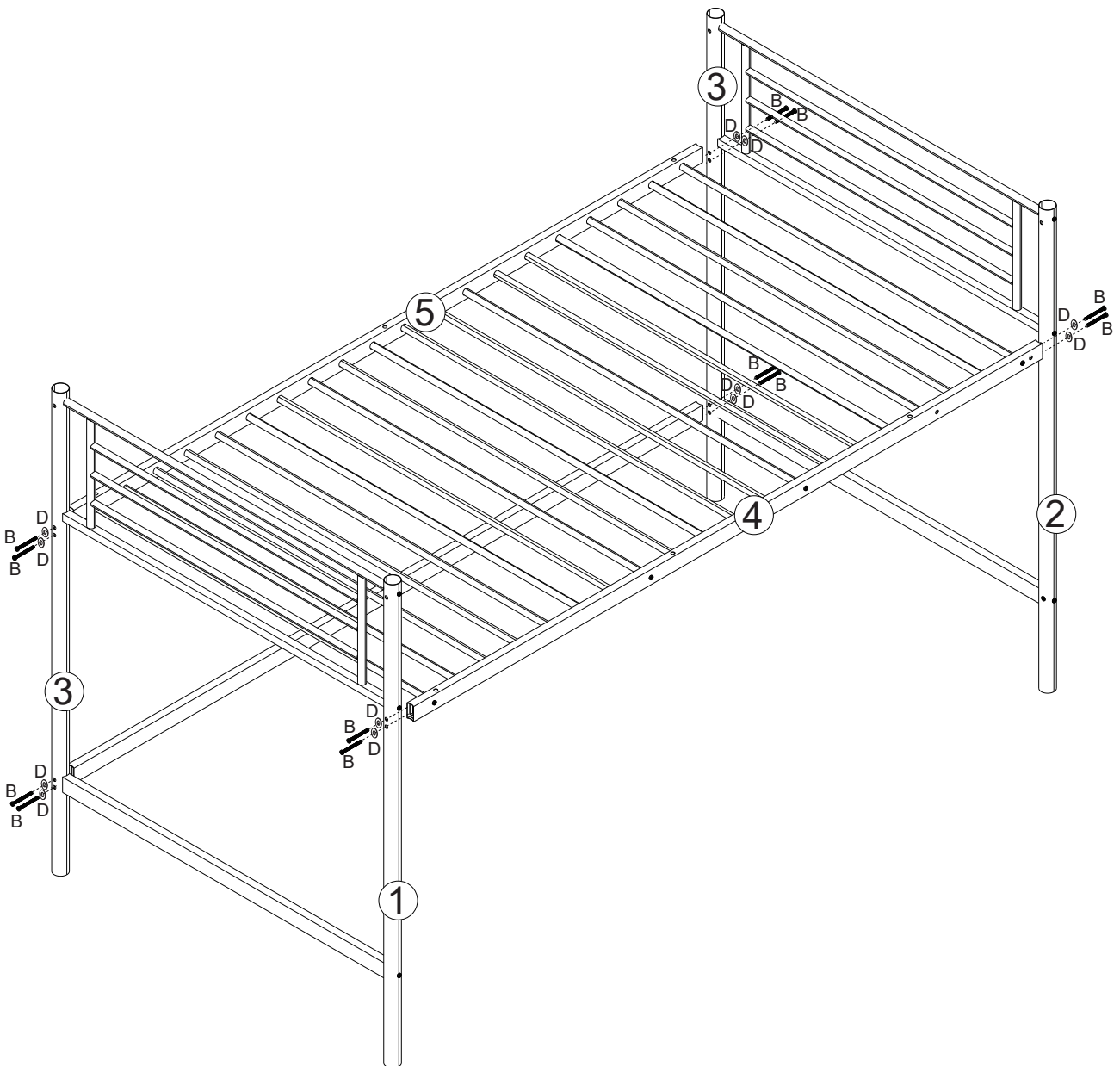

STEP 4

CODE	HARDWARE	QTY
B	 M6x60	12
D		12
H		1

1. Attach front rail (4) to assembled frames (step1),(step2) with screw (B) and washer (D).
2. Attach back rail (5) to assembled frames (step1),(step2) with screw (B) and washer (D).





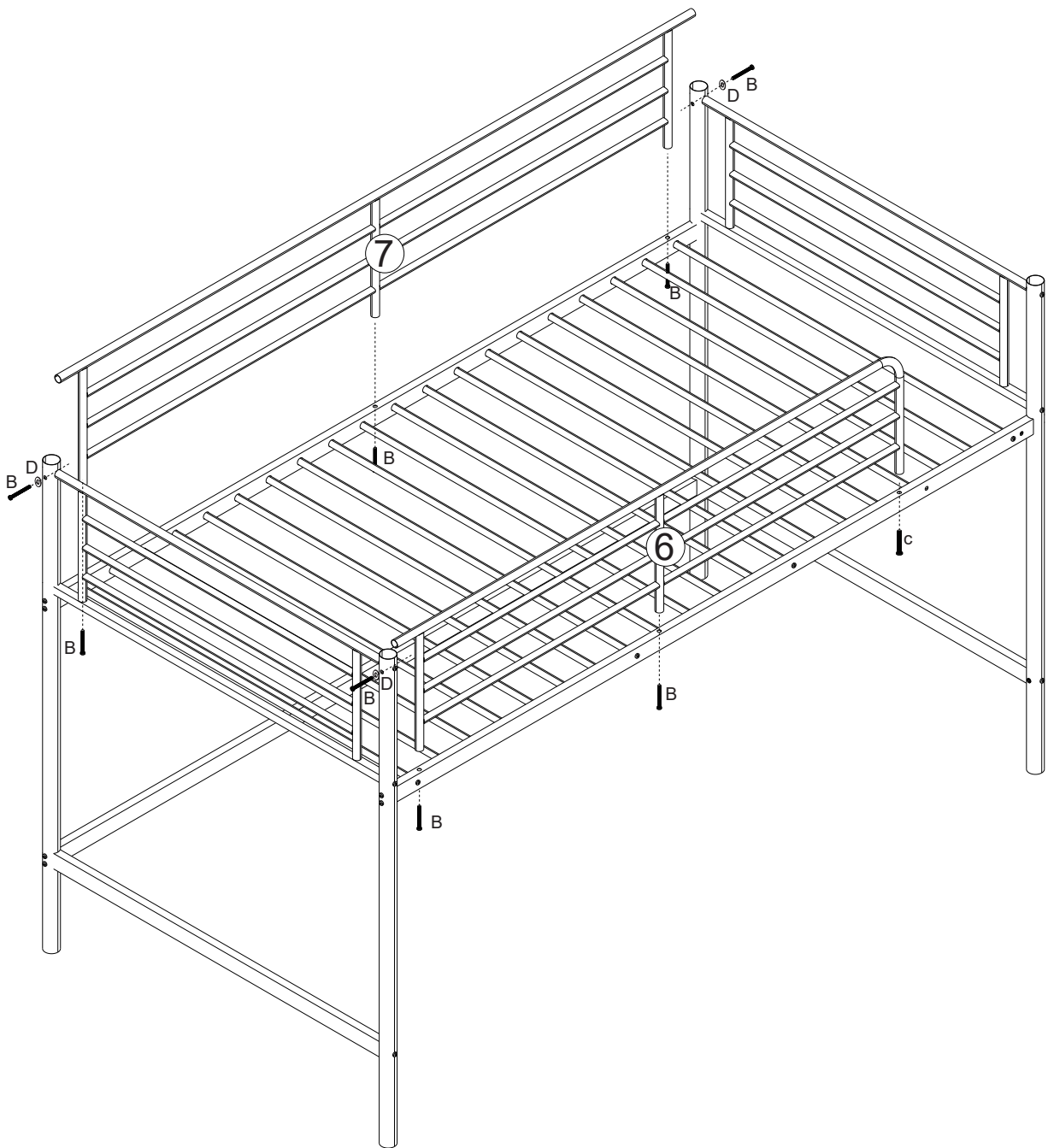

STEP 5

CODE	HARDWARE	QTY
B	 M6x60	8
C	 M8x55	1
D		3
H		1

1. Attach front guard rail (6) to assembled frames (step4) with screw (B) , washer (D) and screw (C).
2. Attach rear guard rail (7) to assembled frames (step4) with screw (B) and washer (D).





STEP 6

CODE	HARDWARE	QTY
A	 M6x12	2
B	 M6x60	2
G		2
H		1
I		1

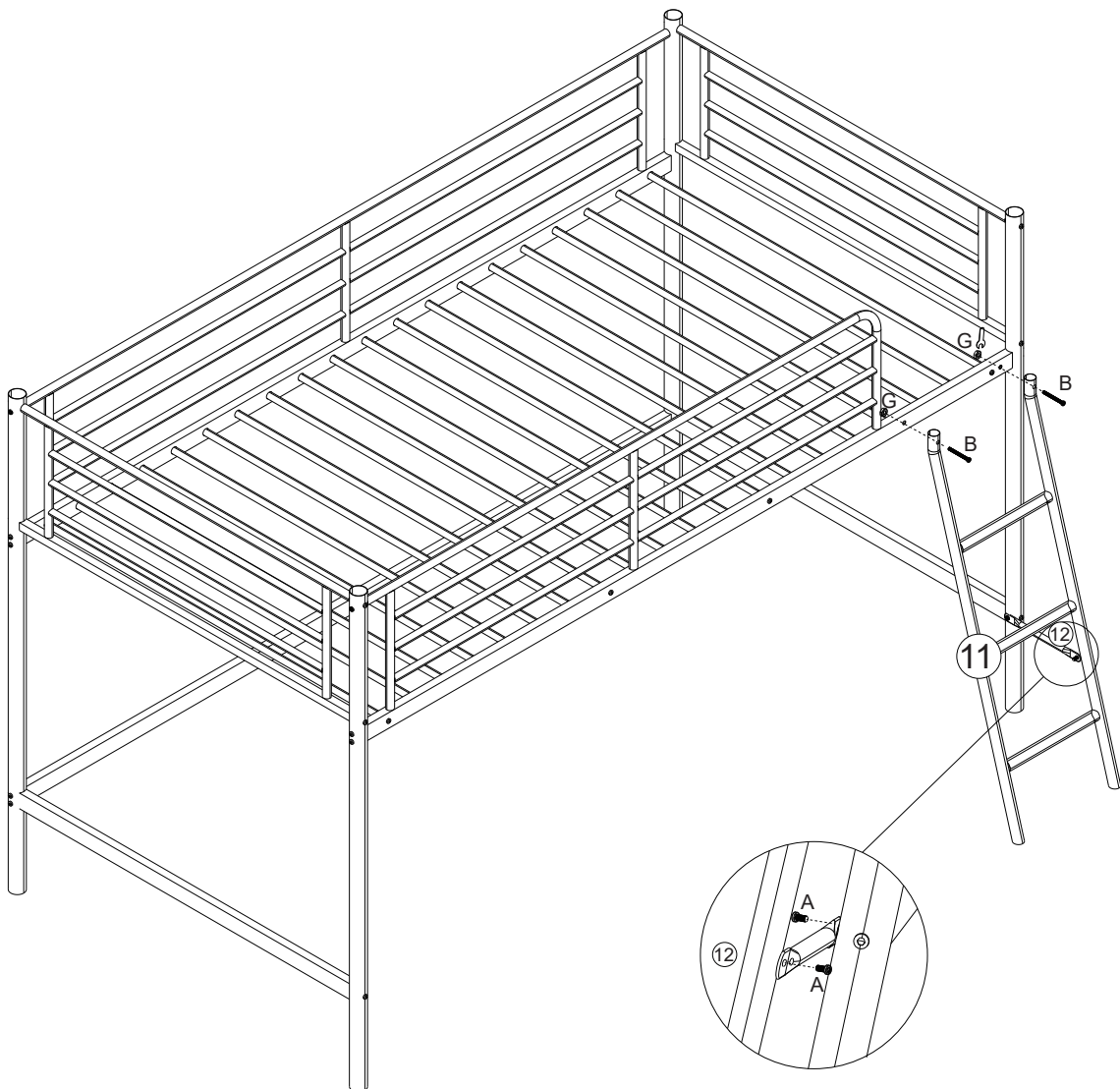
1. Connect the stair (11) to the assembled frame (STEP5) with screw (B) and nut (G).
2. Connect the stair (11) and the assembled frame (STEP5) with connecting strip (12), and then tighten and fasten them with screw (A).



STEP 7

CODE	HARDWARE	QTY
E1		2
E2		2
E3		2

1. First, drill two holes in the wall and embed the plastic anchor (E1) into the holes.
2. Then, use the screw (E3) to pass through the anti-tipping kit (E2) to fix it onto the wall

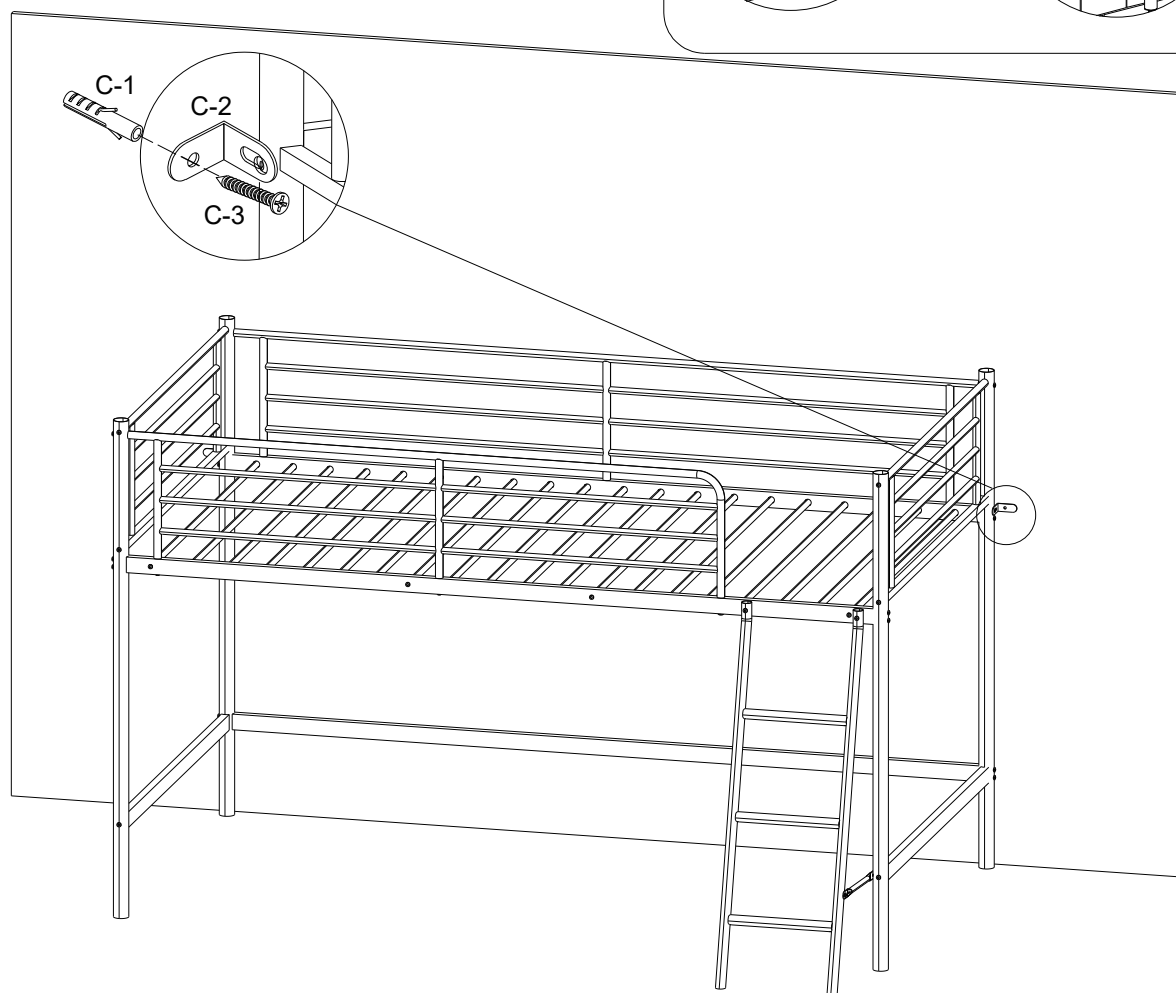
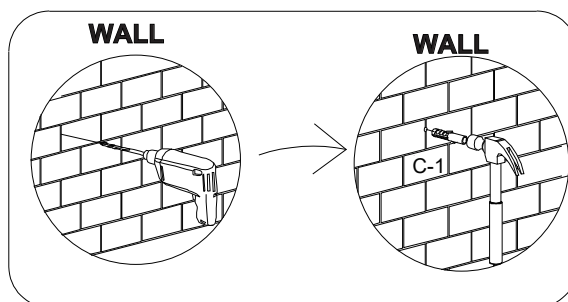

STEP 8

You can enjoy your new bed frame Now ~

Note: Do not step directly on the bed frame before you place the mattress on.

