

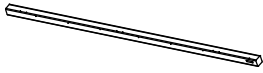









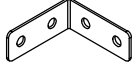

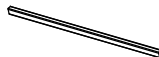
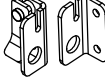

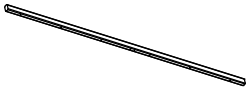
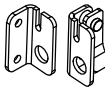
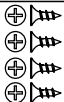
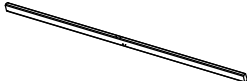
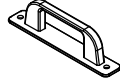

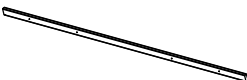

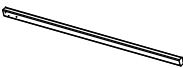

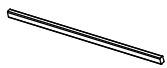
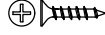

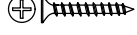

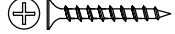

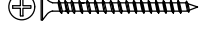
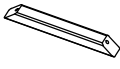
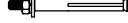

| | | | | | |
|----|---|----|----|---|-----|
| A |  | 4 | Q1 |  | 5 |
| B1 |  | 6 | Q2 |  | 24 |
| B2 |  | 9 | S |  | 8 |
| B3 |  | 3 | T1 |   | 1 |
| C |  | 6 | T2 |   | 1 |
| D1 |  | 2 | U |   | 2 |
| D2 |  | 2 | V |  | 3 |
| E1 |  | 2 | H1 |  M4x15 | 5 |
| E2 |  | 1 | H2 |  M4x25 | 145 |
| E3 |  | 2 | H3 |  M4x35 | 51 |
| E4 |  | 1 | H4 |  M4x45 | 112 |
| F |  | 4 | H5 |  M4x60 | 5 |
| G1 |  | 8 | H6 |  M6x50 | 9 |
| G2 |  | 2 | H7 |  M6-10 | 1 |
| G3 |  | 4 | H8 |  | 2 |
| J |  | 2 | | | |
| K |  | 1 | | | |
| P |  | 12 | | | |

1

| | | | | | |
|----|--|----|----|---|----|
| C |  | 6 | B1 |  | 6 |
| B3 |  | 3 | Q2 |  | 18 |
| H2 |  M4x25 | 72 | | | |

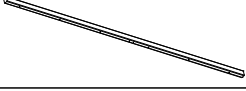
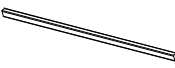
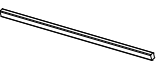
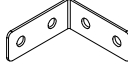

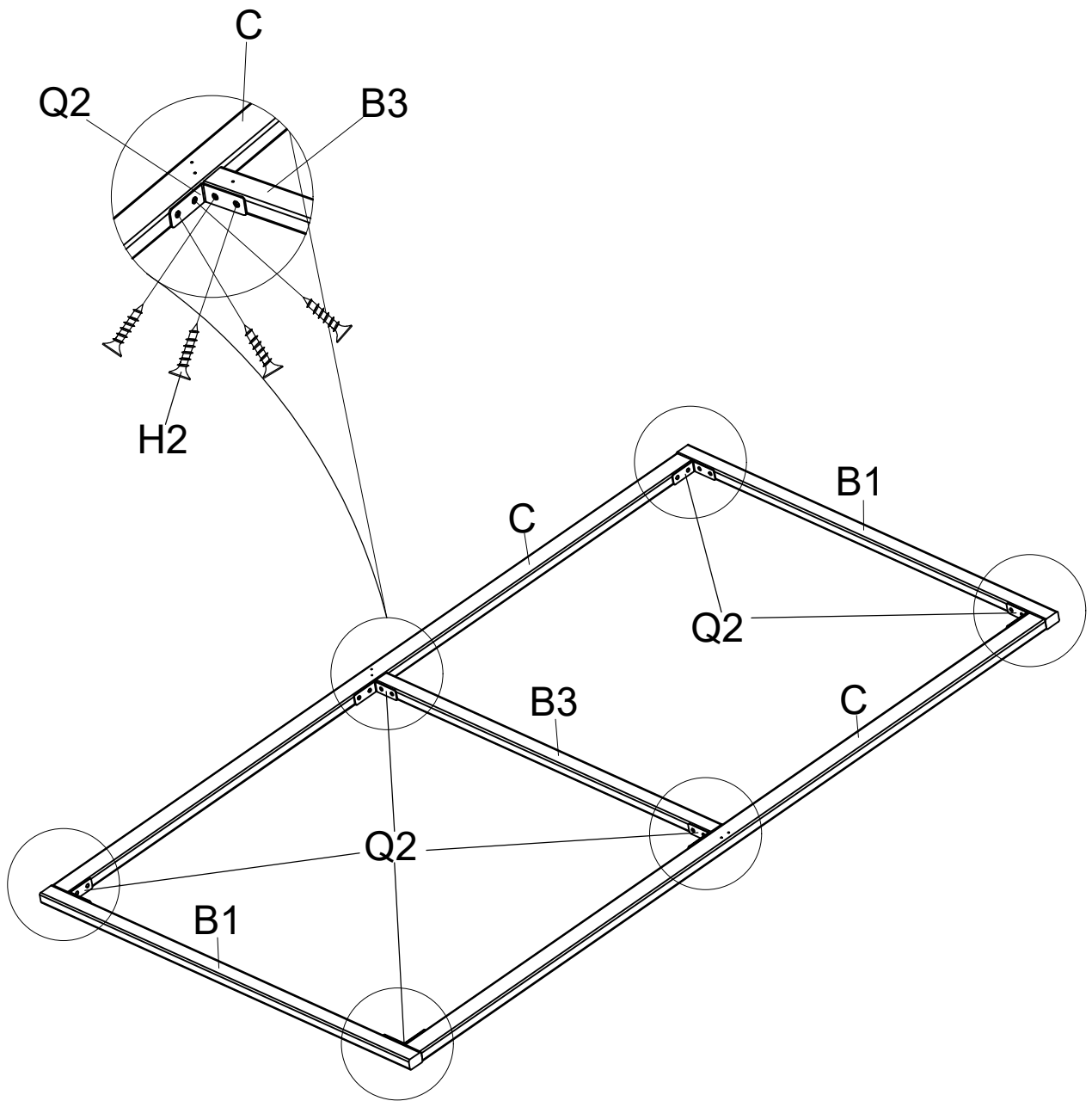

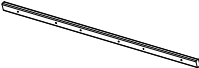
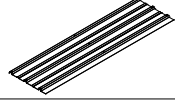
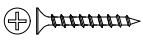
2

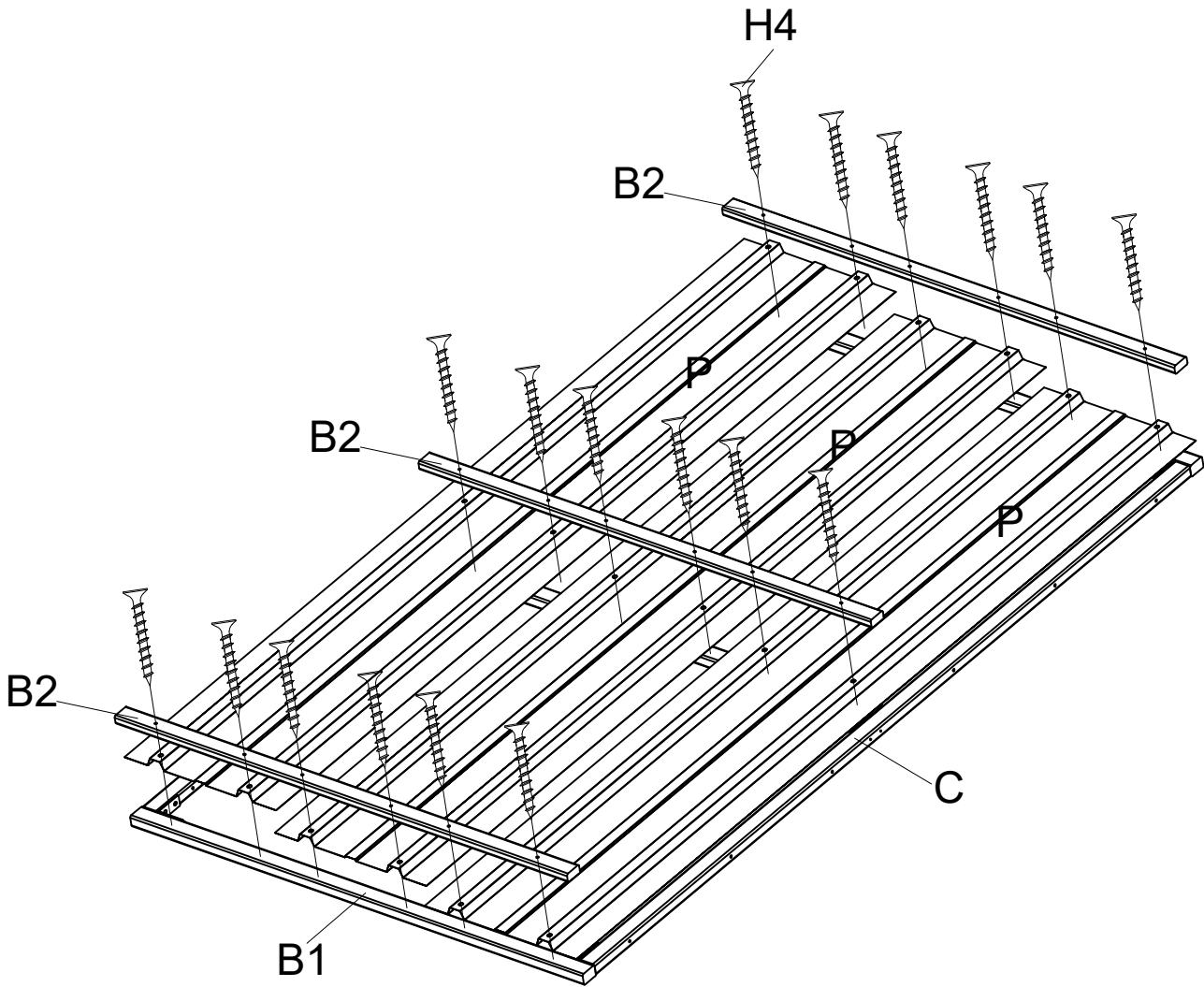
| | | | | | |
|----|--|----|---|---|---|
| B2 |  | 9 | P |  | 9 |
| H4 |  M4x45 | 54 | | | |

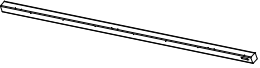

3

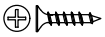
| | | | | | |
|----|--|---|---|---|---|
| A |  | 4 | F |  | 2 |
| H2 |  M4x25 | 4 | | | |

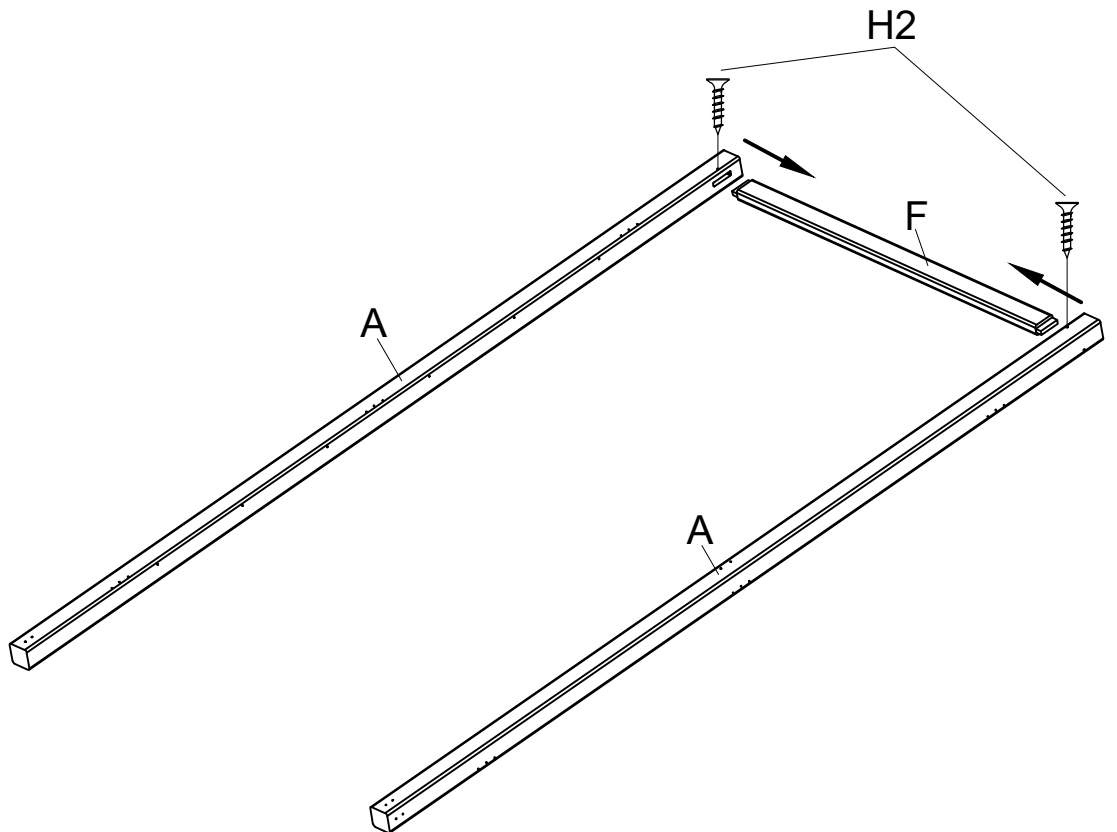
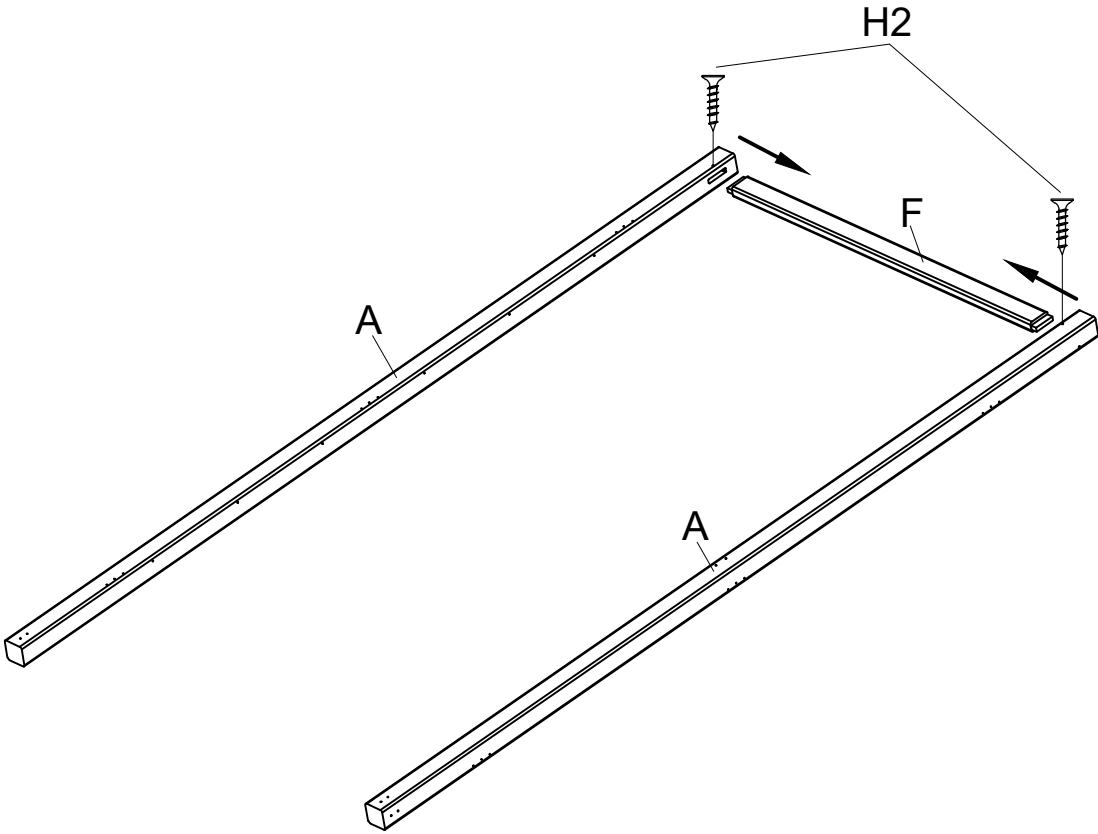

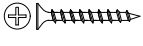

4

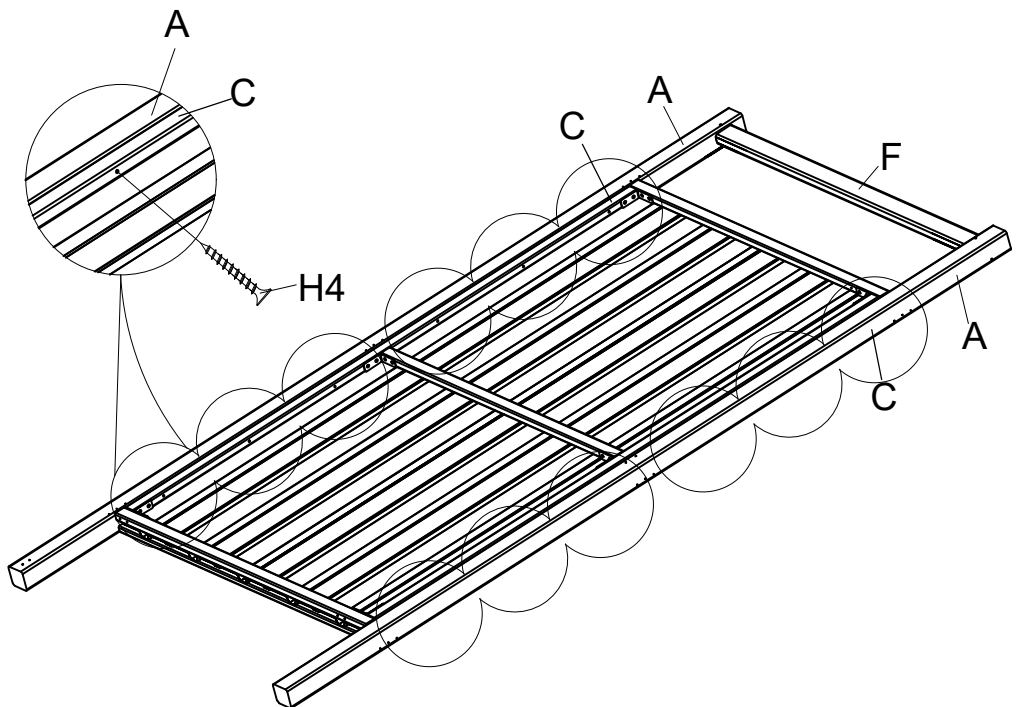
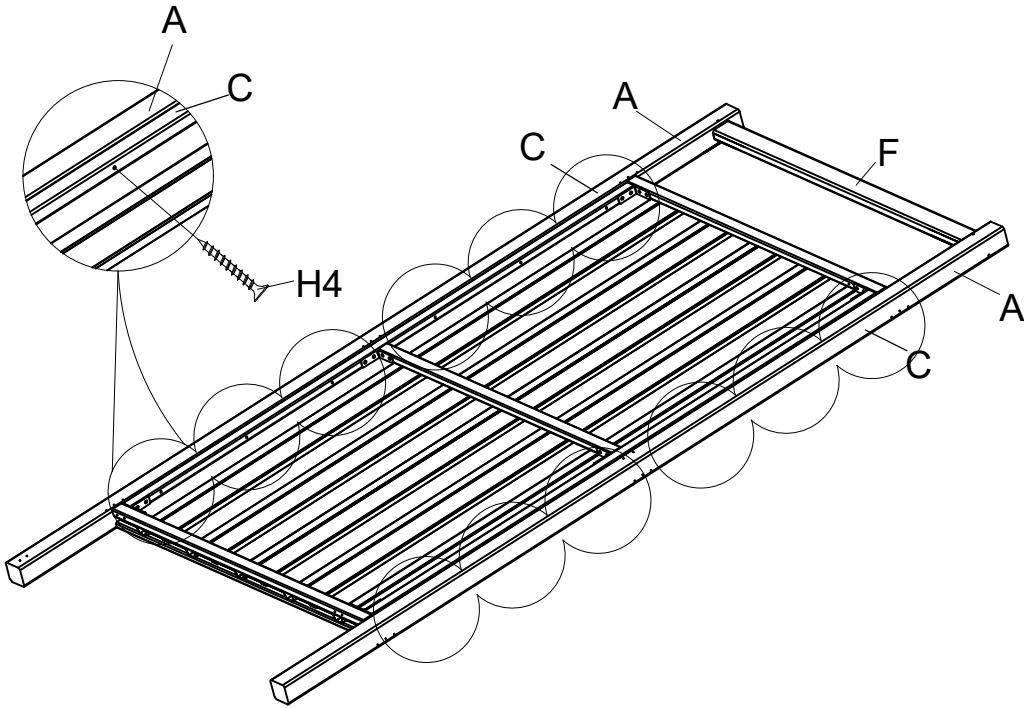
| | | |
|----|--|----|
| H4 |  M4x45 | 24 |
|----|--|----|



5

| | | | | | |
|---|---|---|----|--|---|
| F |  | 2 | H2 |  M4x25 | 4 |
|---|---|---|----|--|---|

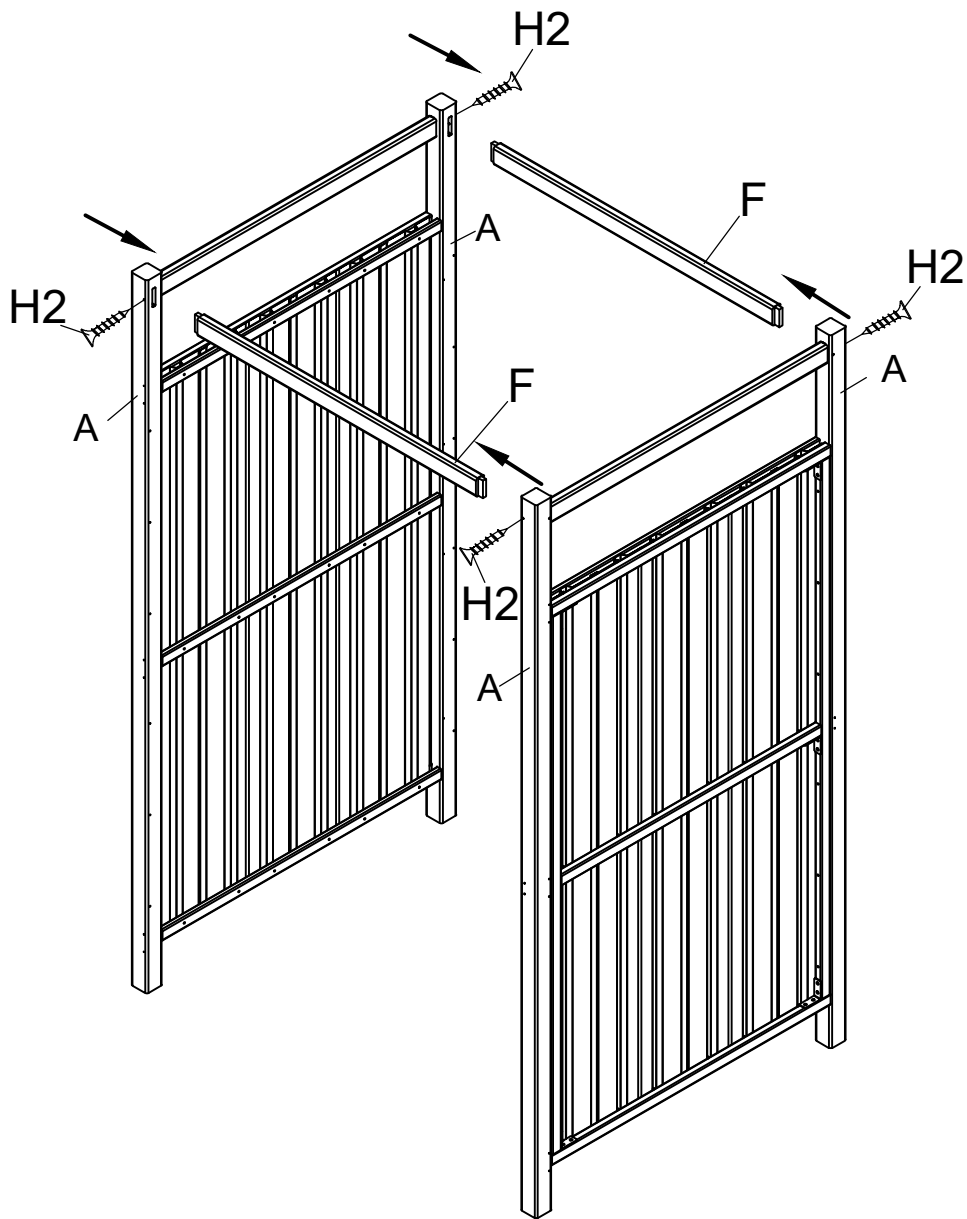

6

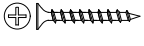
| | | |
|----|--|---|
| H5 |  M4x45 | 6 |
|----|--|---|

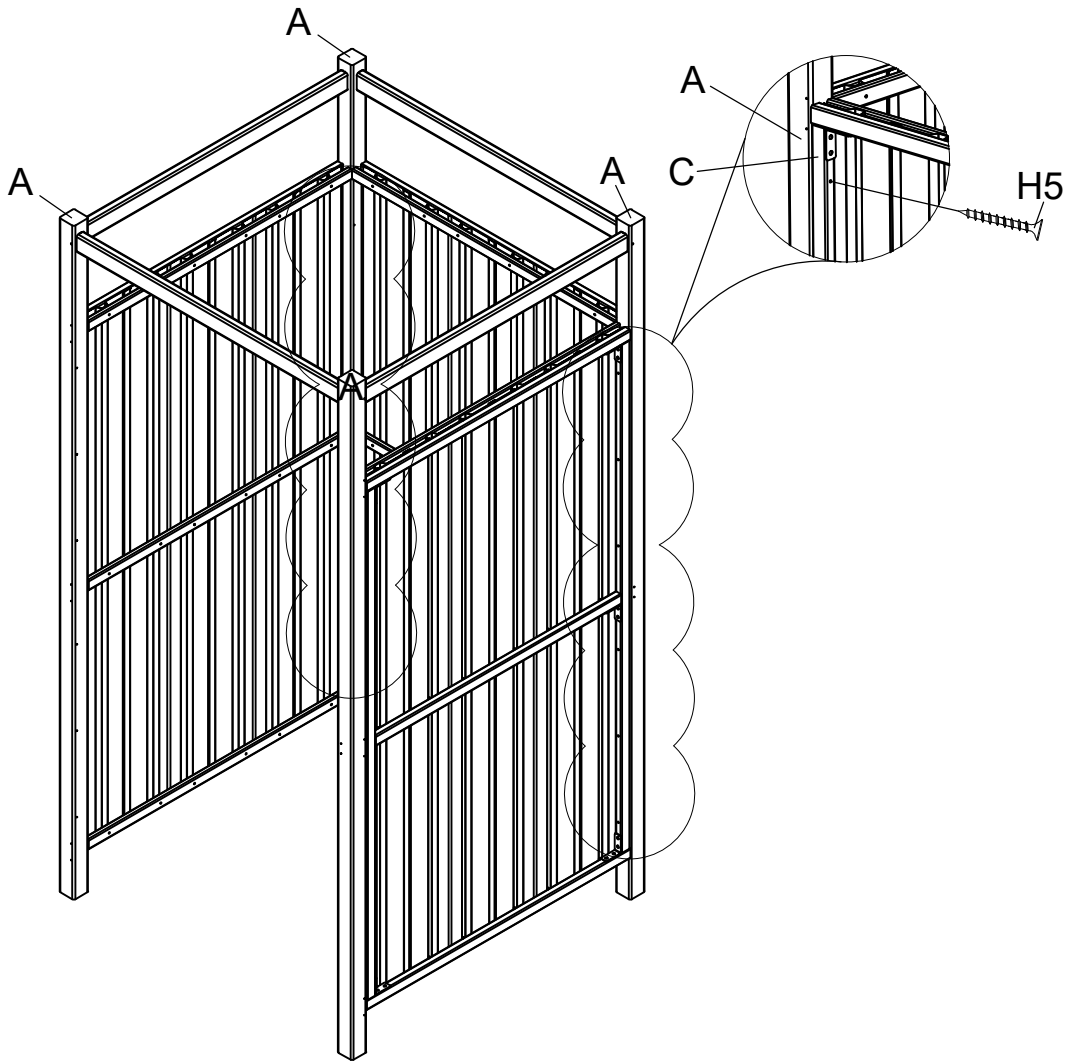

7

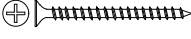
| | | | | | |
|----|---|---|----|--|---|
| G3 |  | 4 | H5 |  M4x60 | 4 |
|----|---|---|----|--|---|

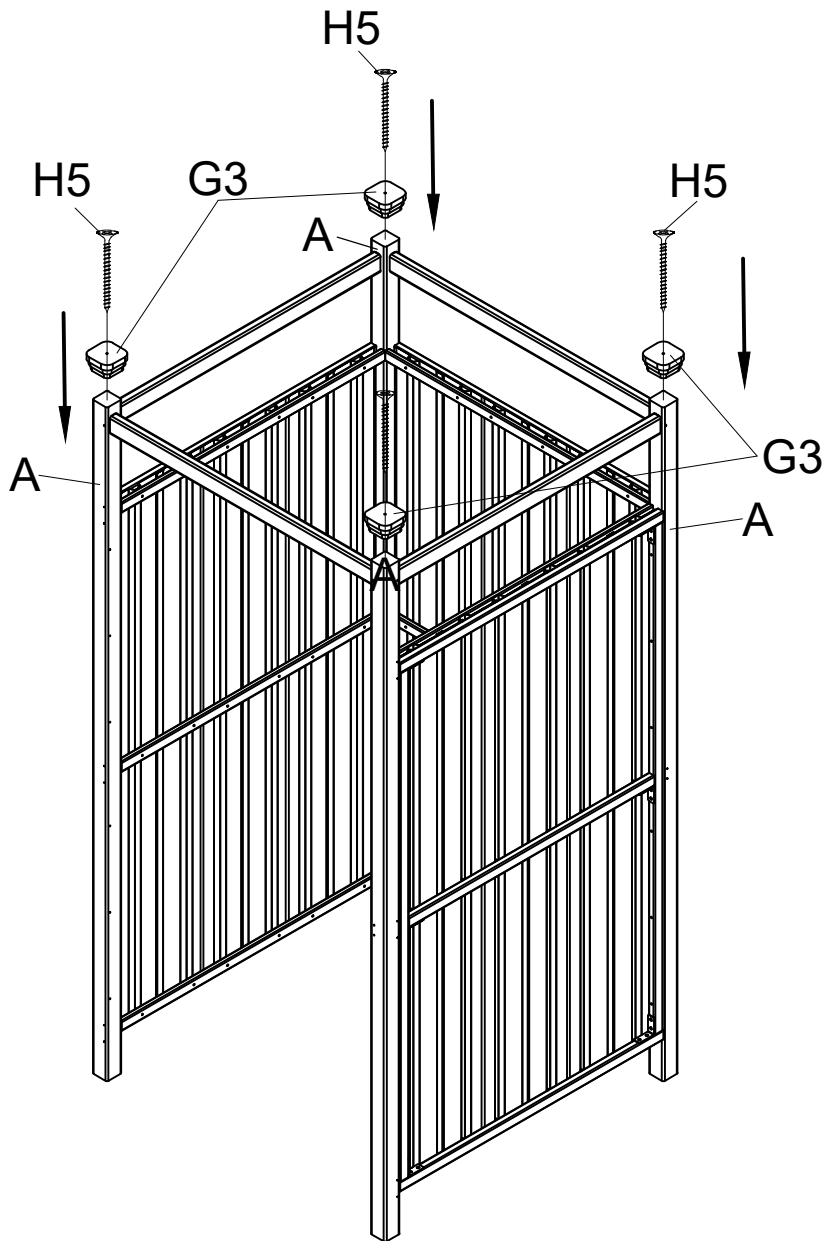

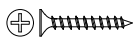

8

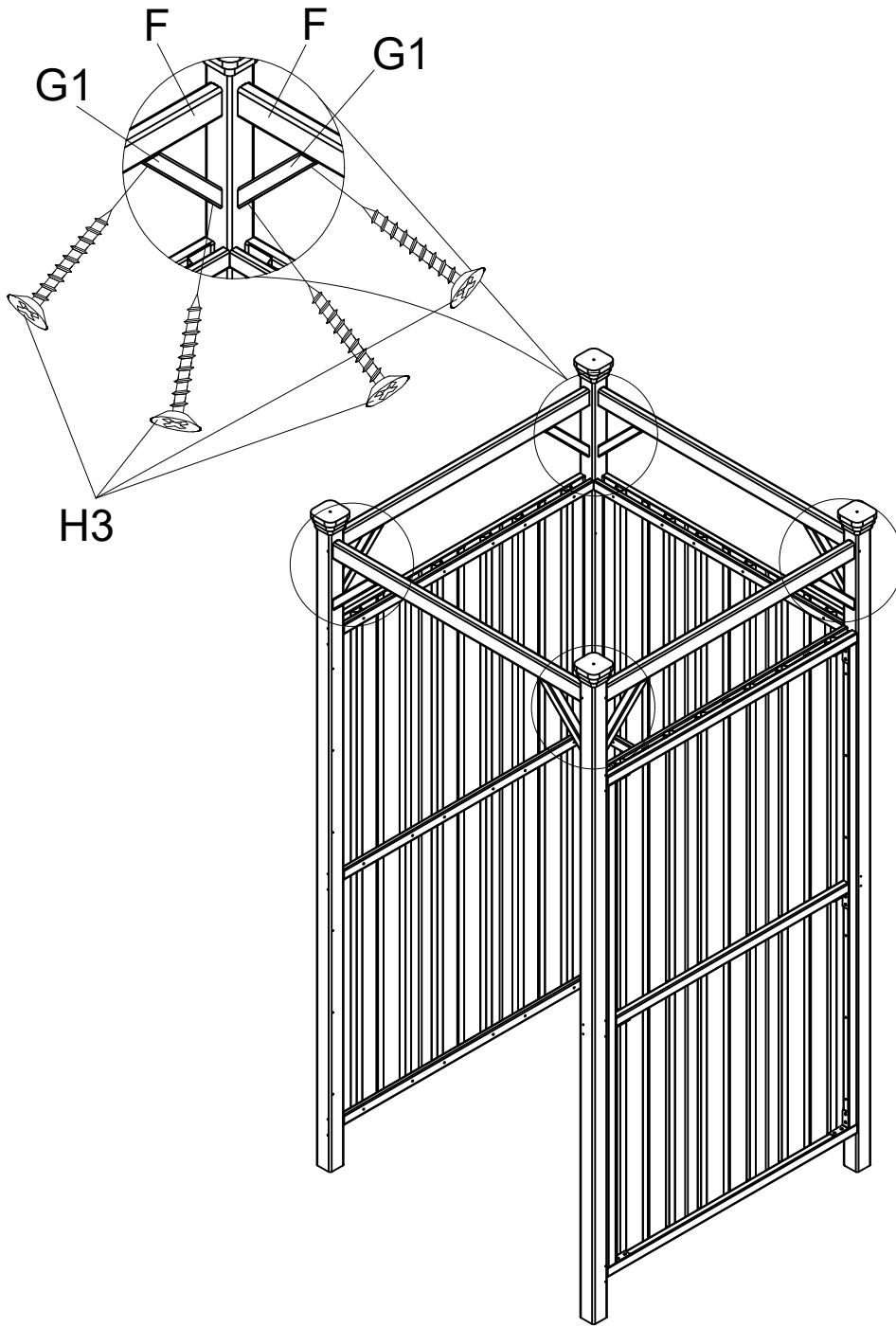
| | | | | | |
|----|---|---|----|--|----|
| G1 |  | 8 | H3 |  M4x35 | 16 |
|----|---|---|----|--|----|

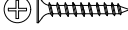

9

| | | | | | |
|----|--|---|----|--|---|
| Q1 |  | 5 | G2 |  | 2 |
| H1 |  M4x15 | 5 | H3 |  M4x35 | 4 |

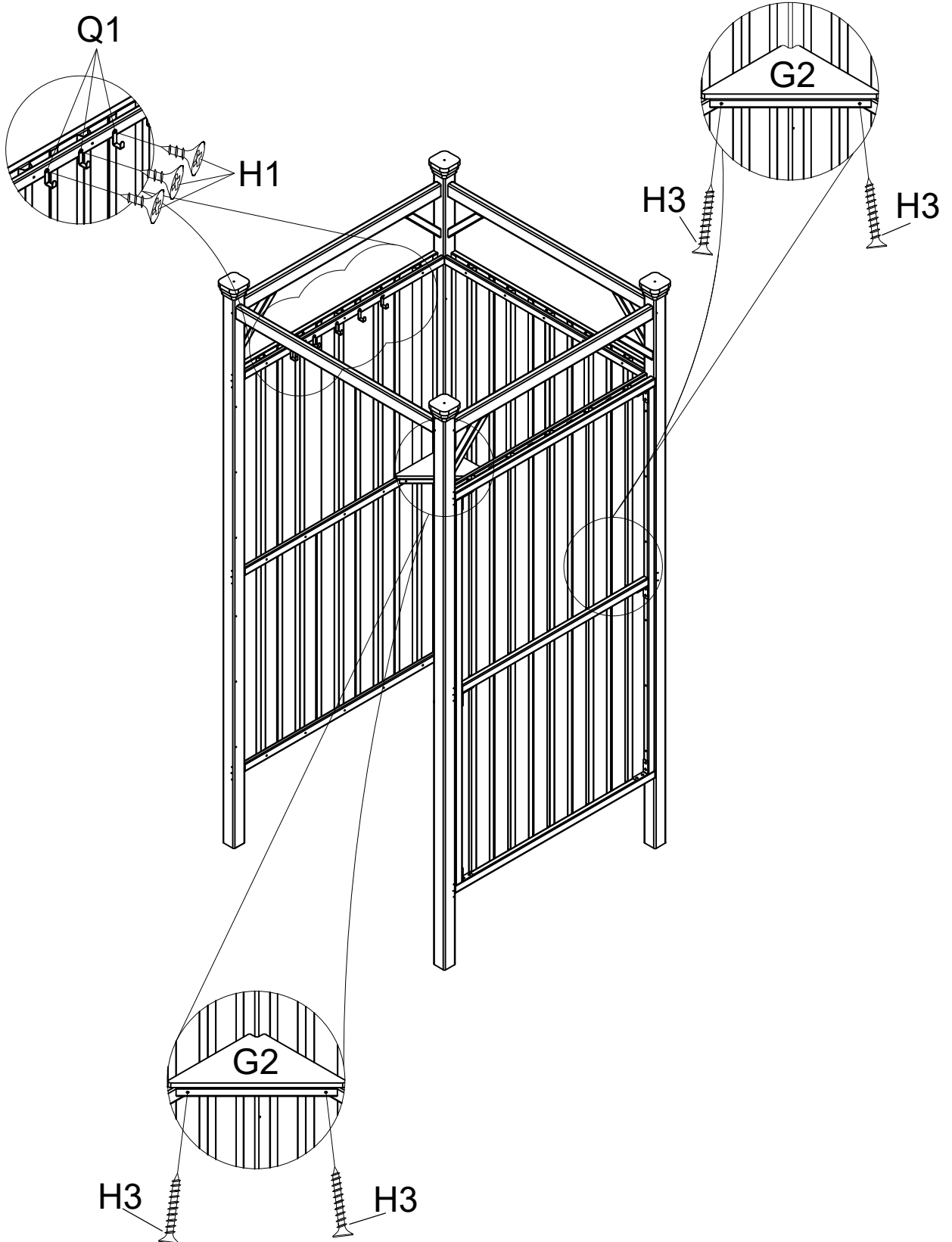

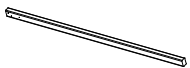
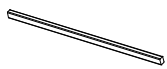
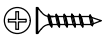
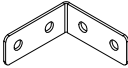

10

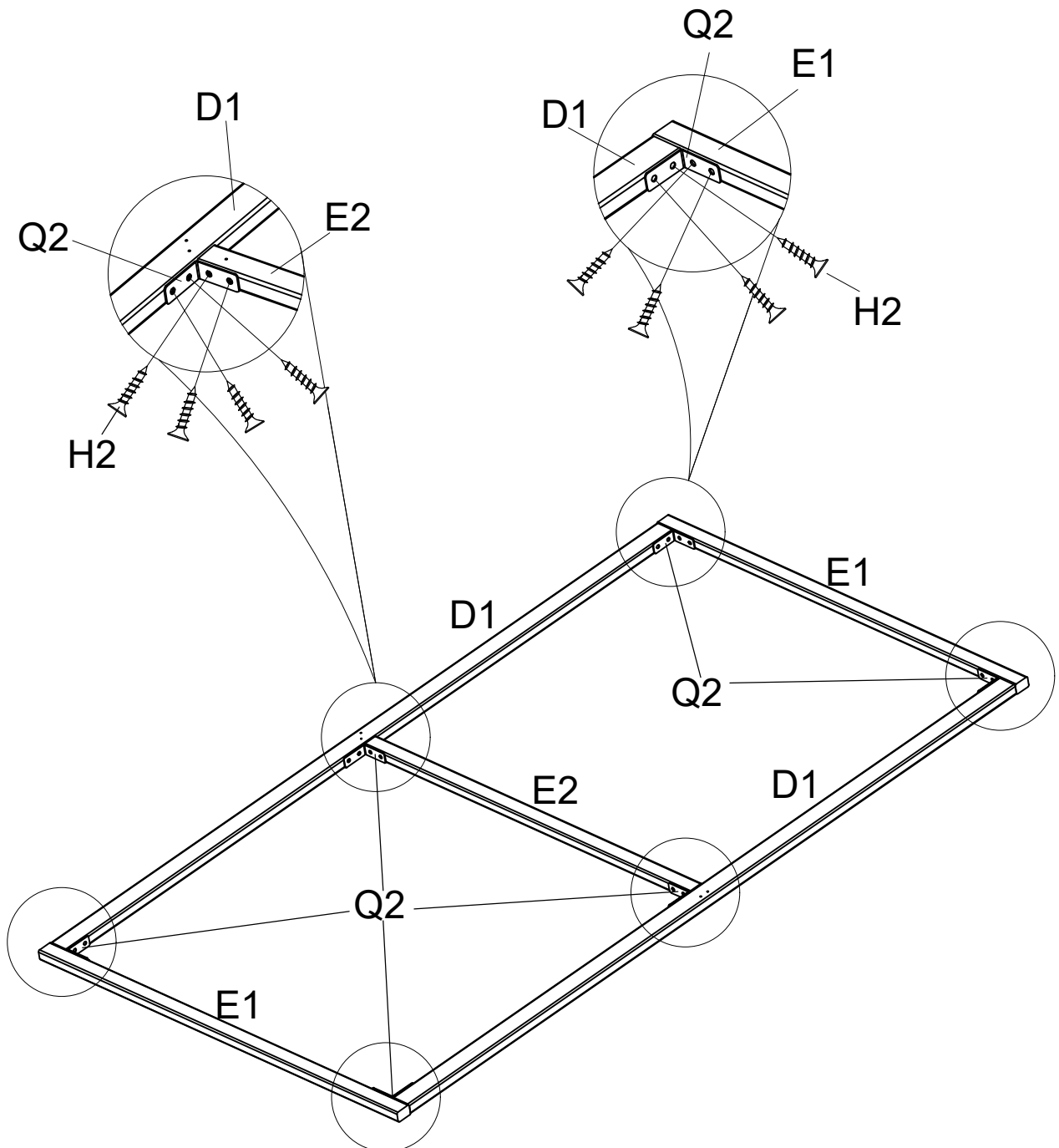
| | | | | | |
|----|---|---|----|--|----|
| D1 |  | 2 | E1 |  | 2 |
| E2 |  | 1 | H2 |  M4x25 | 24 |
| Q2 |  | 6 | | | |



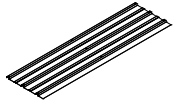
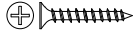
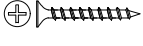

11

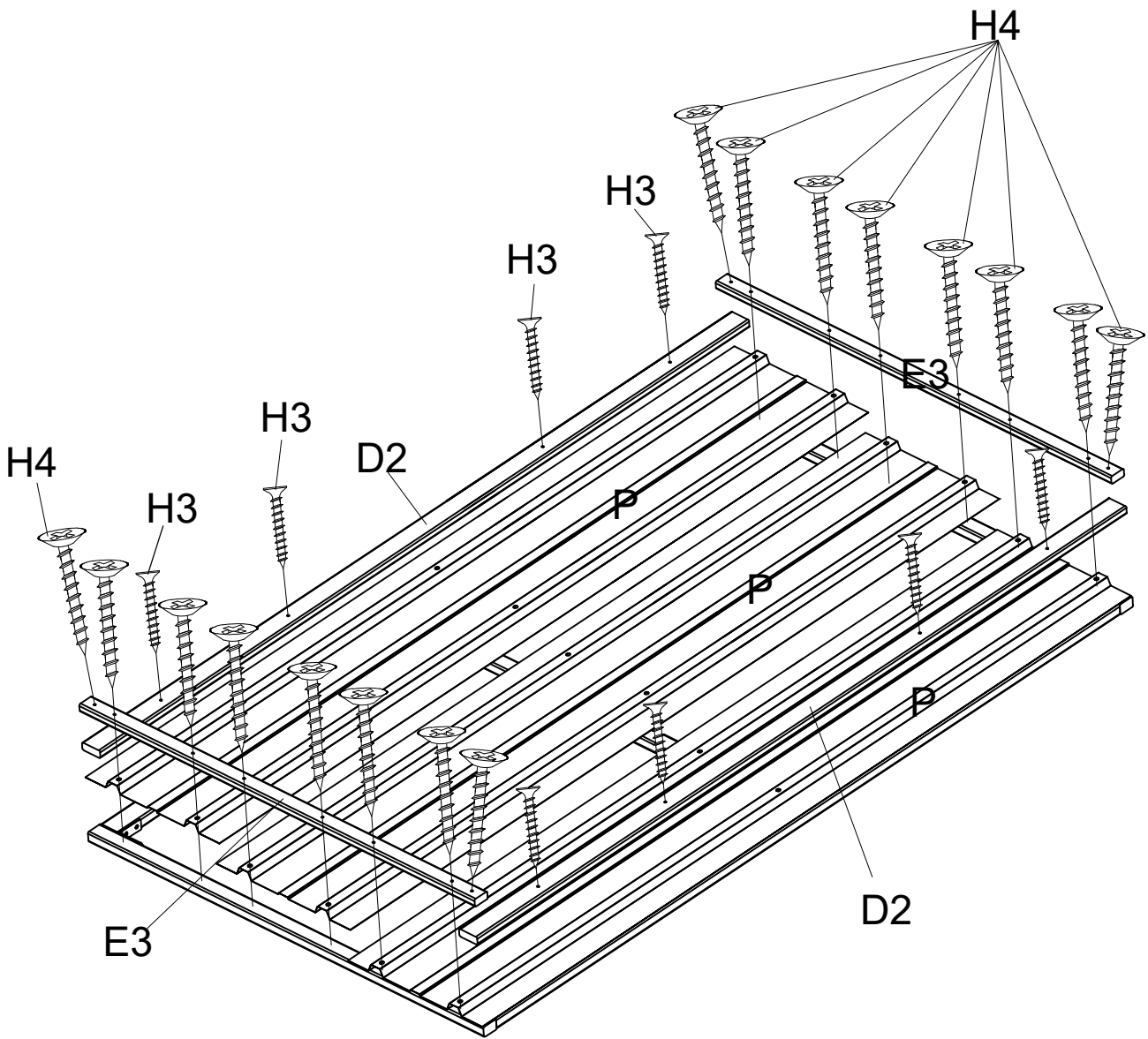
| | | | | | |
|----|--|----|----|--|---|
| D2 |  | 2 | E3 |  | 2 |
| P |  | 3 | H3 |  M4x35 | 8 |
| H4 |  M4x45 | 16 | | | |



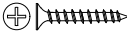

12

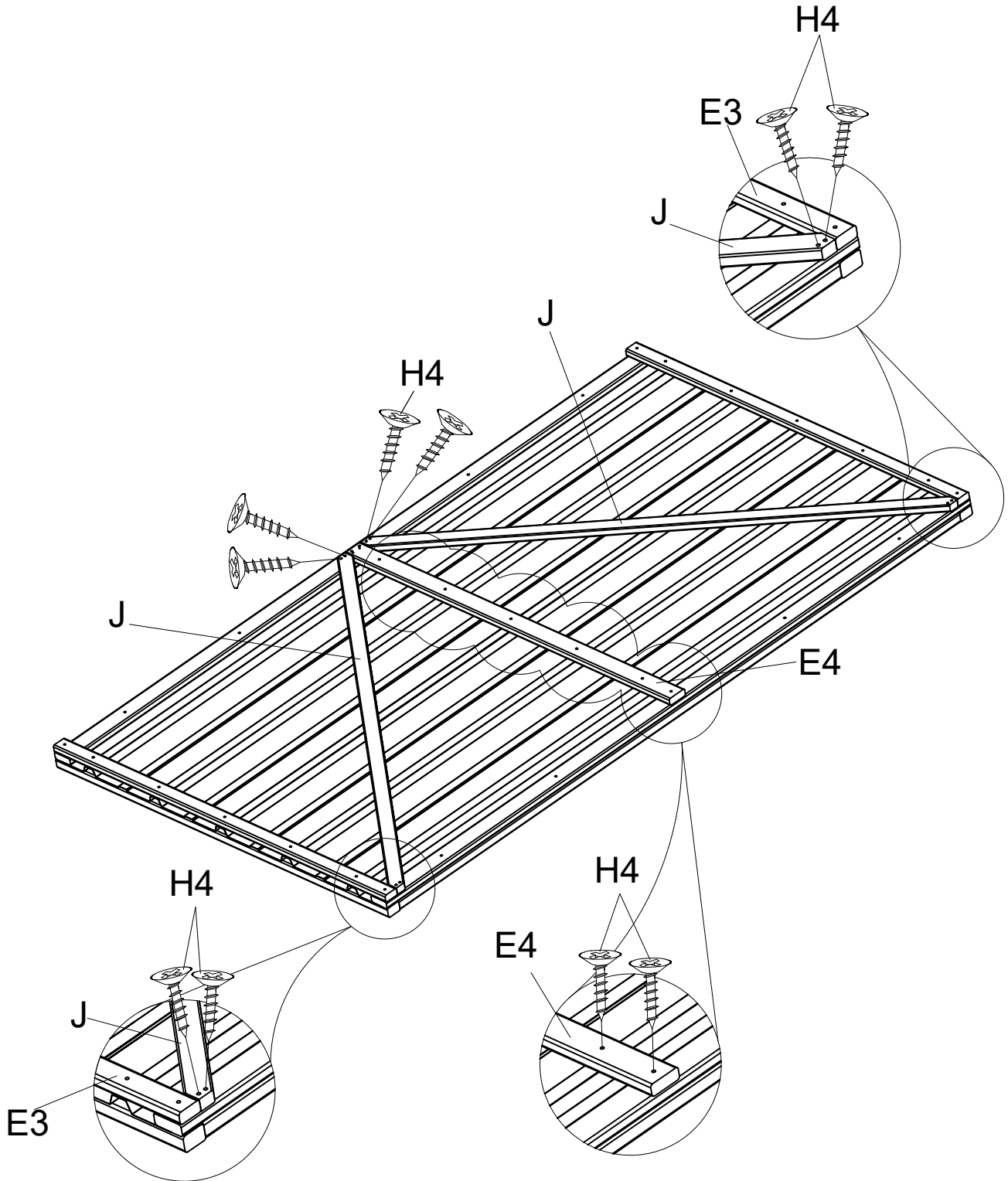
| | | | | | |
|----|--|----|---|---|---|
| E4 |  | 1 | J |  | 2 |
| H3 |  M4x35 | 14 | | | |



13

| | | | | | |
|---|---|---|----|--|---|
| V |  | 3 | H2 |  M4x25 | 9 |
|---|---|---|----|--|---|

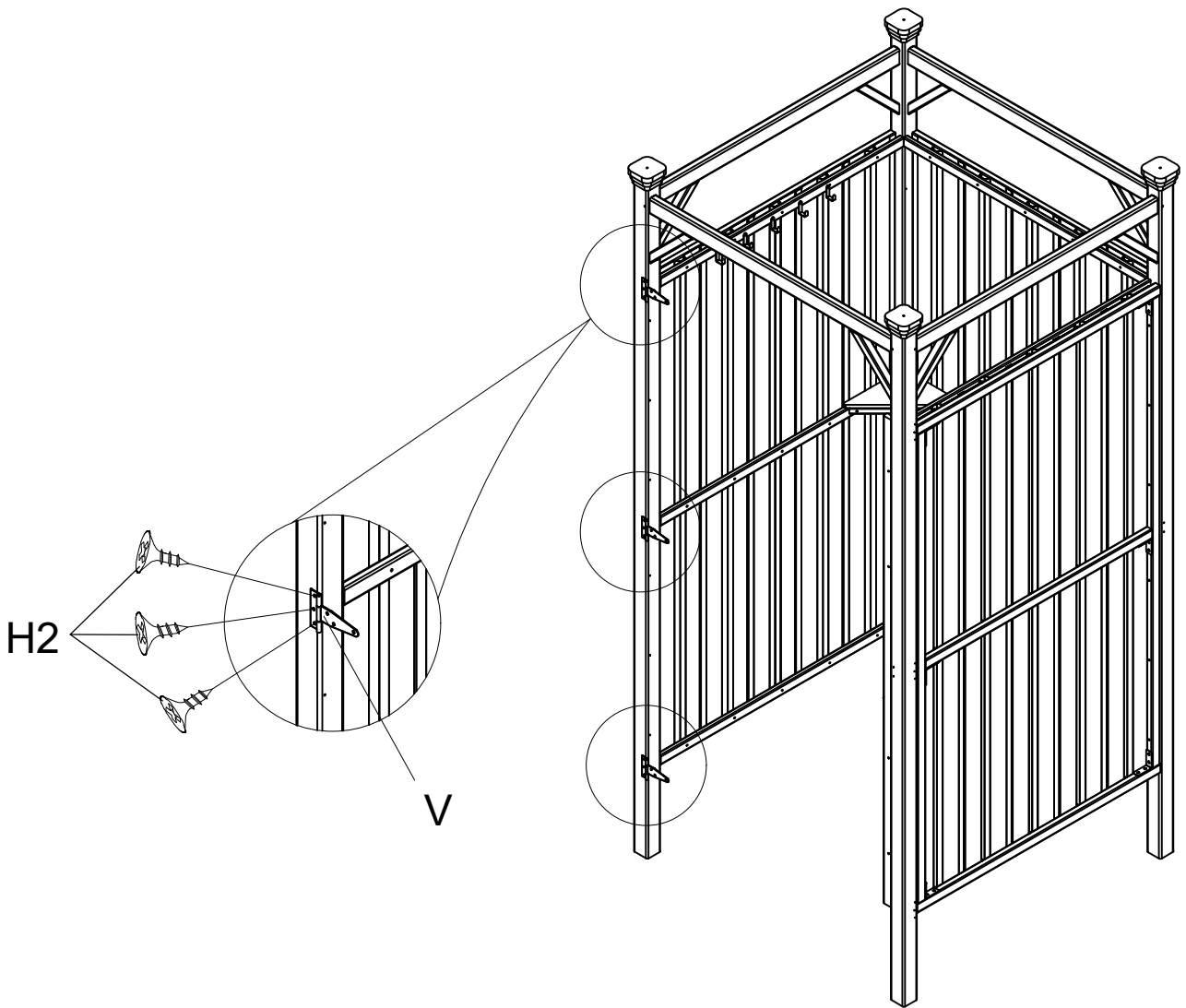

| | | |
|----|--|---|
| H2 |  M4x25 | 9 |
|----|--|---|

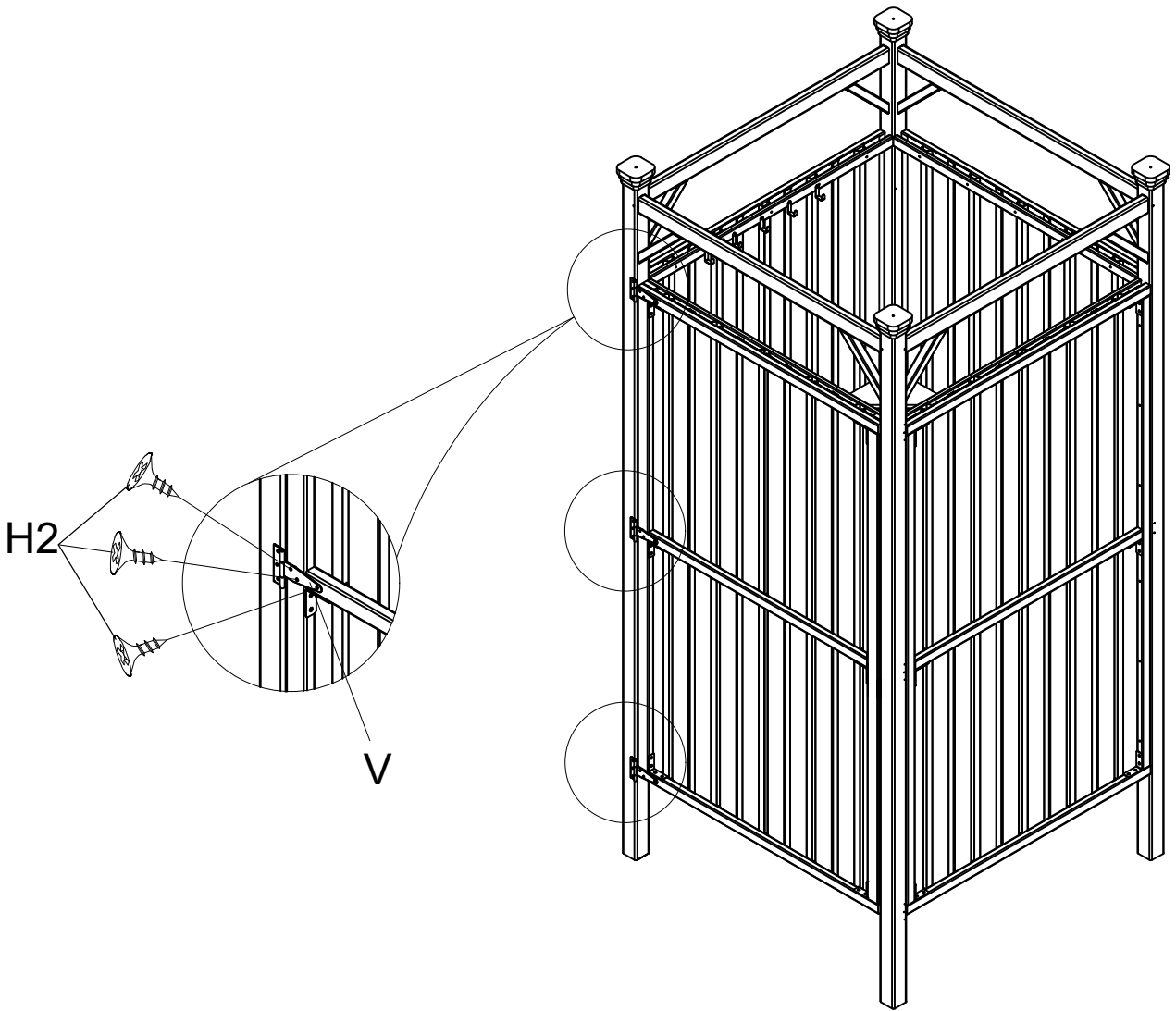

15

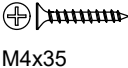

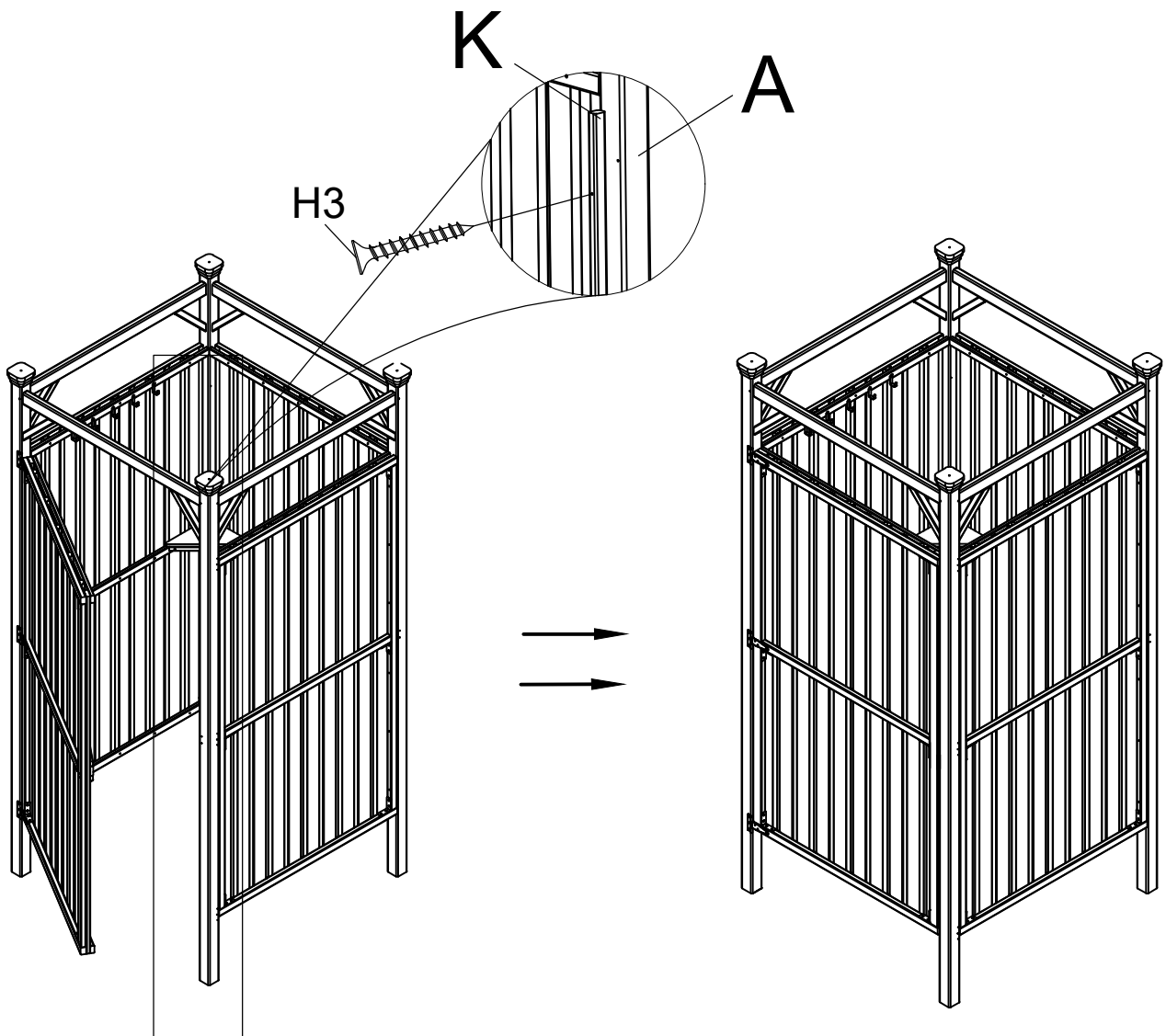
| | | | | | |
|---|---|---|----|--|---|
| K |  | 1 | H3 |  M4x35 | 6 |
|---|---|---|----|--|---|

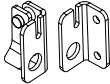
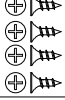
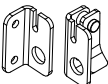
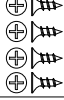

16

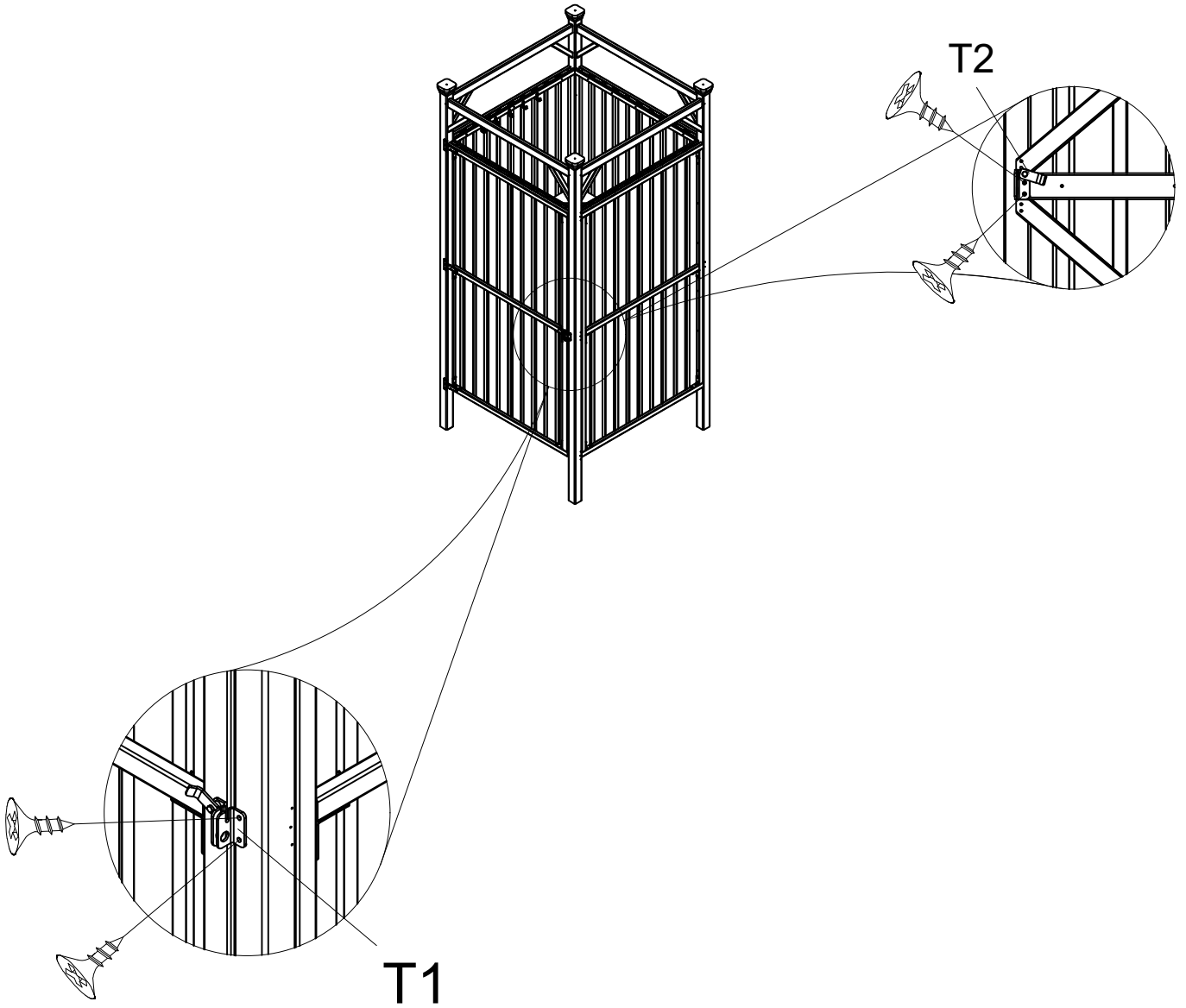
| | | | | | | | |
|----|---|---|---|----|---|---|---|
| T1 |  |  | 1 | T2 |  |  | 1 |
|----|---|---|---|----|---|---|---|

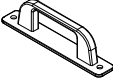

| | | | |
|---|---|--|---|
| U |  |   | 2 |
|---|---|--|---|

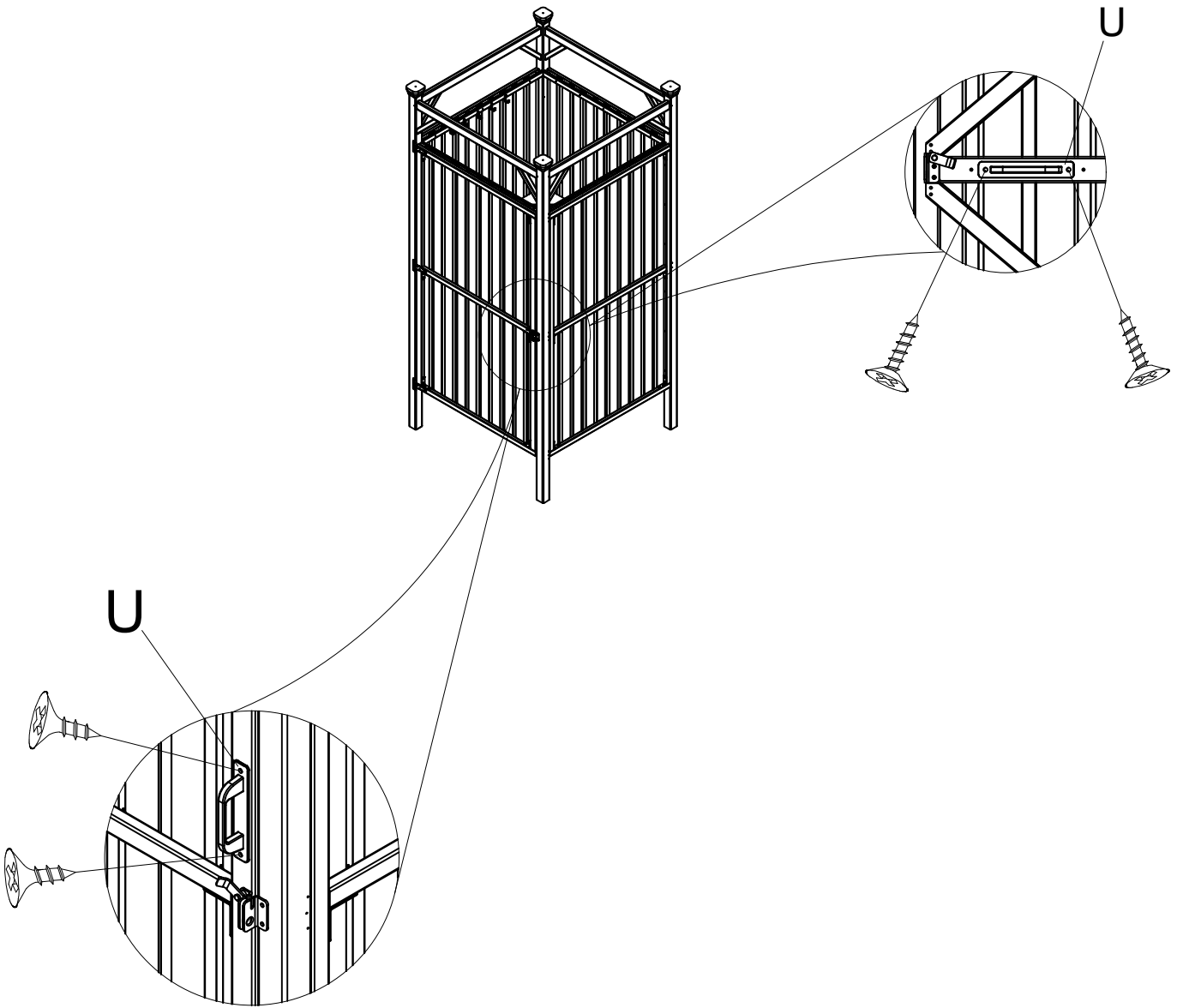

18

| | | | | | |
|---|---|---|----|--|----|
| S |  | 8 | H2 |  M4x25 | 16 |
|---|---|---|----|--|----|

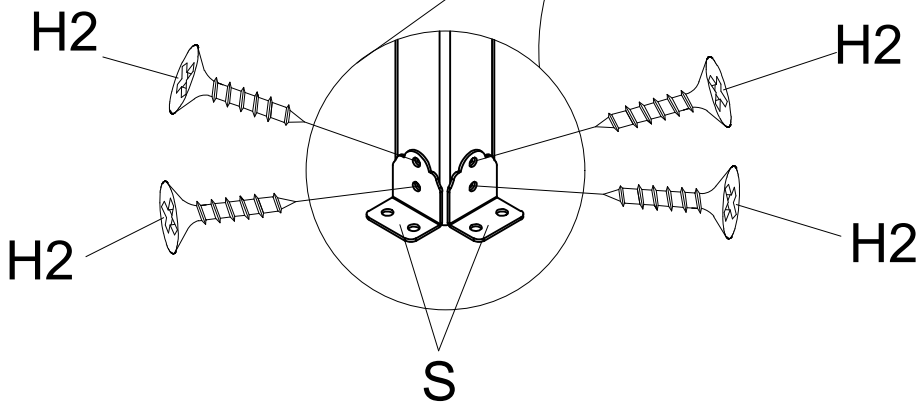
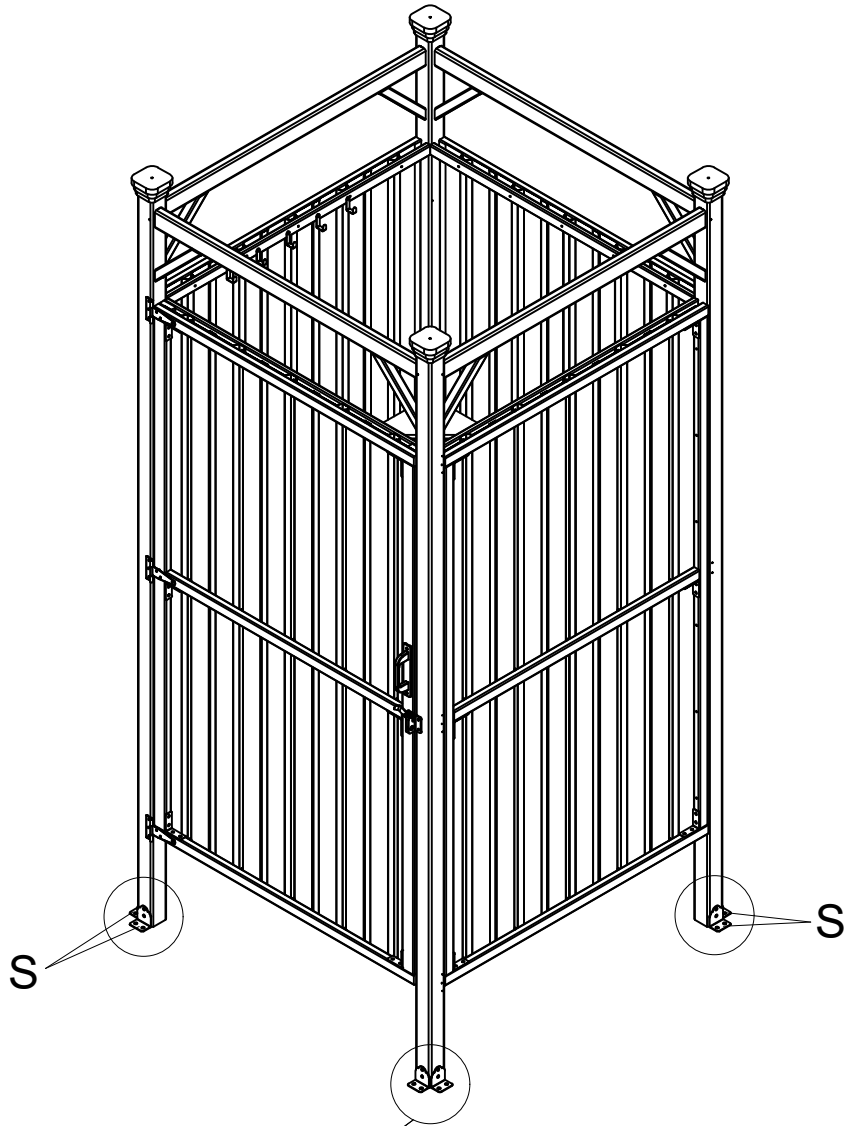

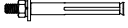
| | | |
|----|--|---|
| H7 |  M8x50 | 8 |
|----|--|---|

