

Assembly Instructions

Caution: You must read this before you proceed

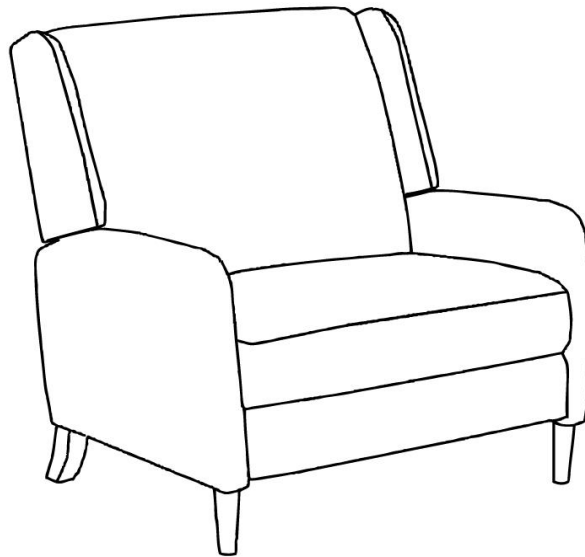

Please look under the seat for hardware packs and legs.

RECLINER



Part List

Label	Picture	Description	QTY
A	A line drawing of the chair base, showing the seat and the lower part of the backrest and armrests.	Chair Base	1
B	A line drawing of the backrest, showing its curved shape and a small latch on the side.	Backrest	1
C	A line drawing of the left wing, showing its curved shape and a small latch on the side.	Left Wing	1





D		Right Wing	1
E		Front Leg with 1 Plastic Gasket	2
F		Hind Leg with 1 Silicone Gasket and 1 Plastic Gasket	2

Hardwares List

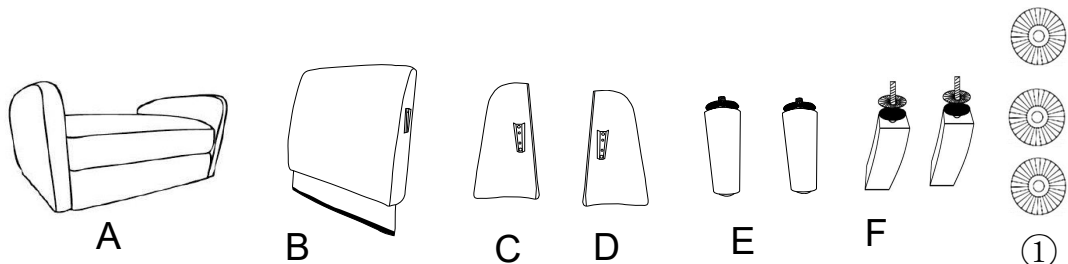
Label	Picture	Description	QTY (pc)
①		Gasket	3

Assembly Preparation

<p>Before Beginning Assembly :</p>	 <p>A B C D E F ①</p>
------------------------------------	---

-  • Read instructions, cover to cover-
-  • Have 2 adults on hand for assembly-
-  • Do not assemble on flooring or carpet-
-  • Assemble on a clean non-marring surface (packing foam)-
-  • Save all packaging until finished-

Assembly Steps

Overview

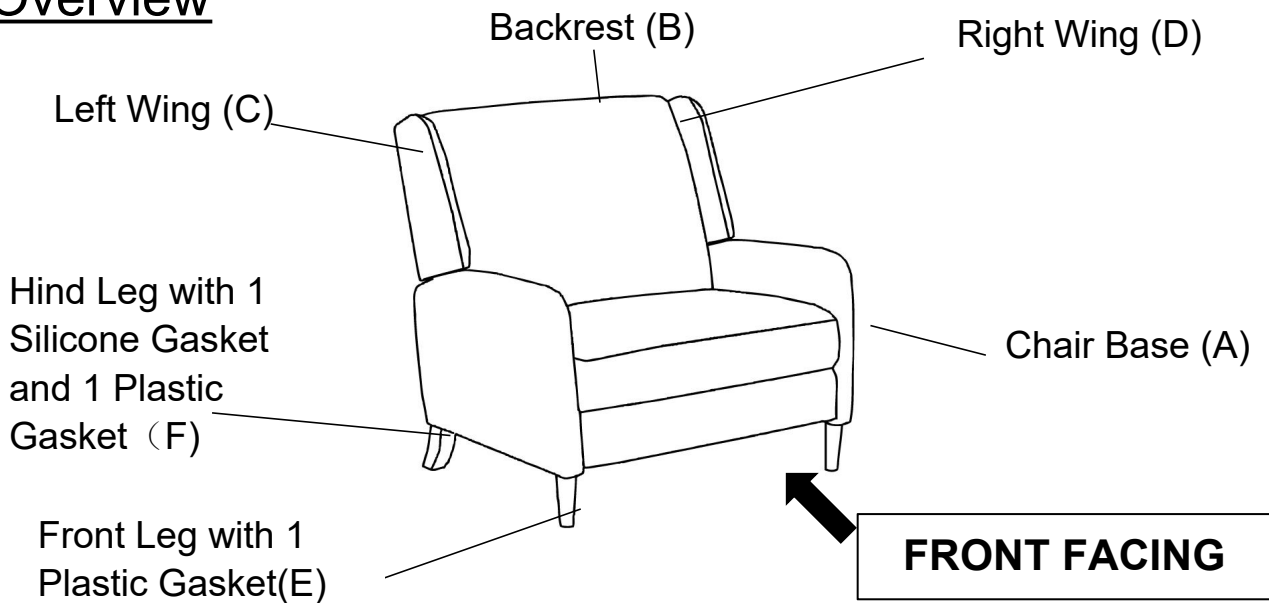

This Recliner has multiple parts and may require about 30 minutes to assemble. To give you an overview of the Recliner parts, the above picture is to help you put the various parts into perspective. Please read through the instructions below to familiarise yourself with the parts and steps before assembly.

Step 1

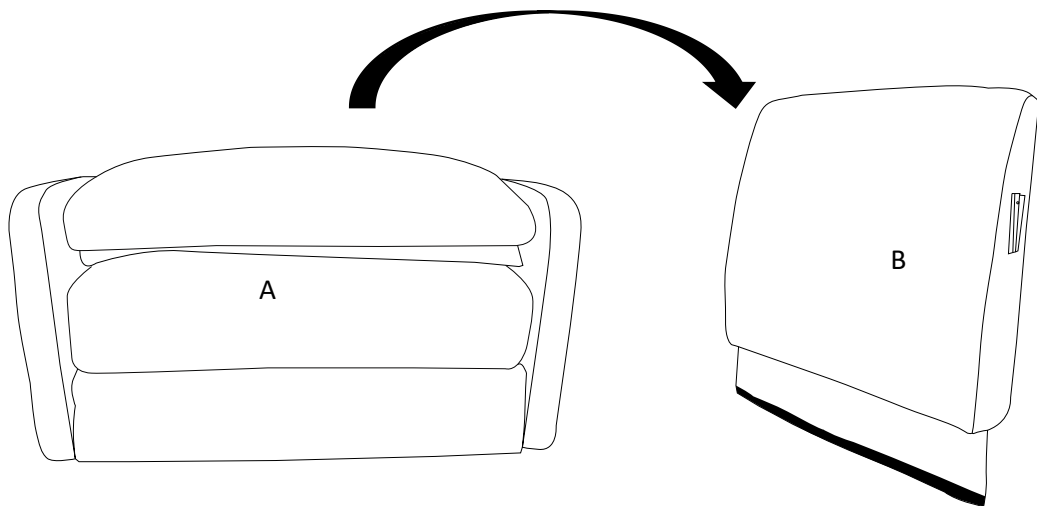

Take the Backrest(B) out from Chair Base(A).
Place the Chair Base(A) facedown on a clean, non-marring surface.

Step 2

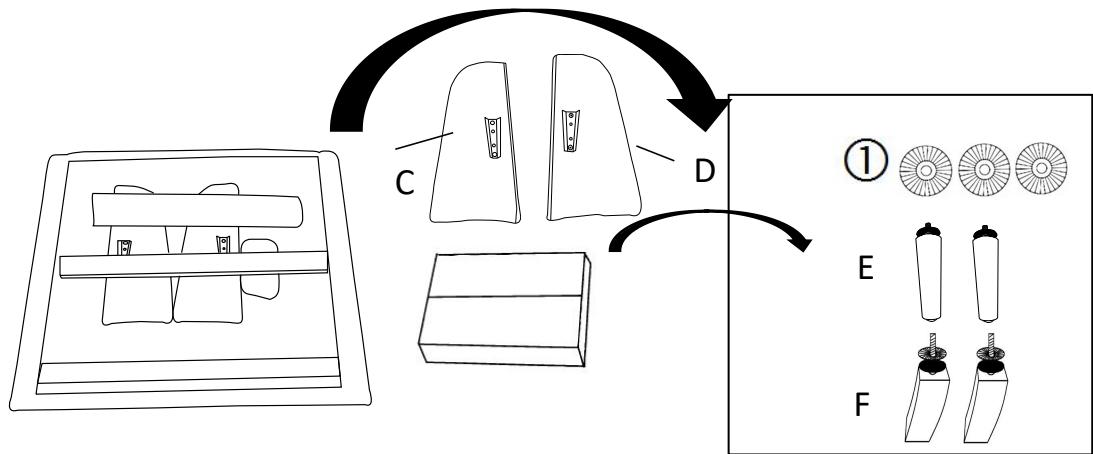

Remove the non-woven bags from the bottom of Chair Base(A) and open the non-woven bags to take out the Left Wing(C) and Right Wing(D). Then take out the small box from the bottom of Chair Base(A) and open the small box to take out the Front Legs with 1 Plastic Gasket(E), Hind Leg with 1 Silicone Gasket and 1 Plastic Gasket(F) and Plastic Gaskets(①).

Step 3

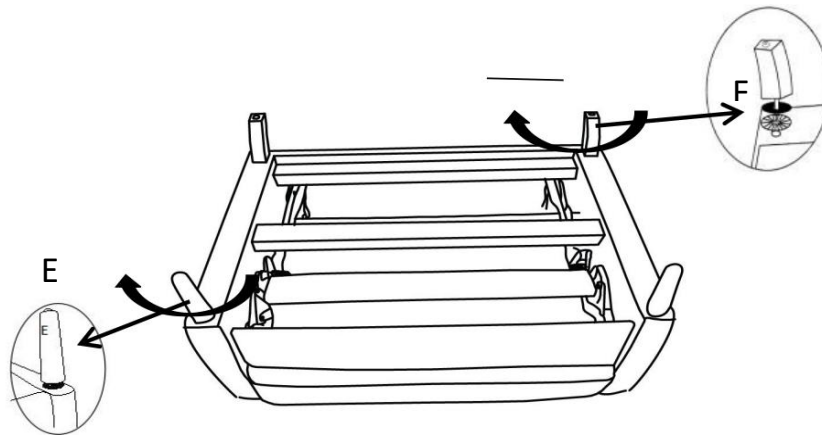

Install the Leg(E) into the bottom of the Chair by placing one Gasket(①) on the threaded stem. Then insert the threaded stem into the mounting position in the corner of the Chair.

Tighten by turning the Leg clockwise.

Do not over tighten.

Repeat the same process to install the remaining two Legs. Take notice of the shape of the Legs and ensure they are in the correct positions.

Note: The use of Gaskets are OPTIONAL and are especially useful to help alleviate slight wobbleness. Some Legs may need more than one gasket whilst some Legs may not need any.

Step 4

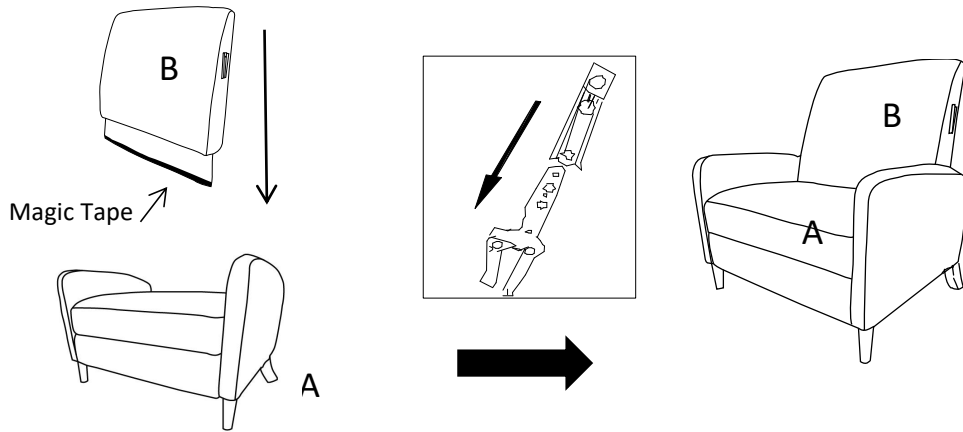

With assistance from your adult partner, hold up the Backrest(B) while standing behind the Chair.

Insert the small metal arms on the sides of the Backrest(B) into the prefabricated slide lock gadgets on the Chair Base (A) as shown above.

Firmly but gently, push the Backrest(B) downwards until the Backrest(B) is fully slotted and locked into position.

Step 5

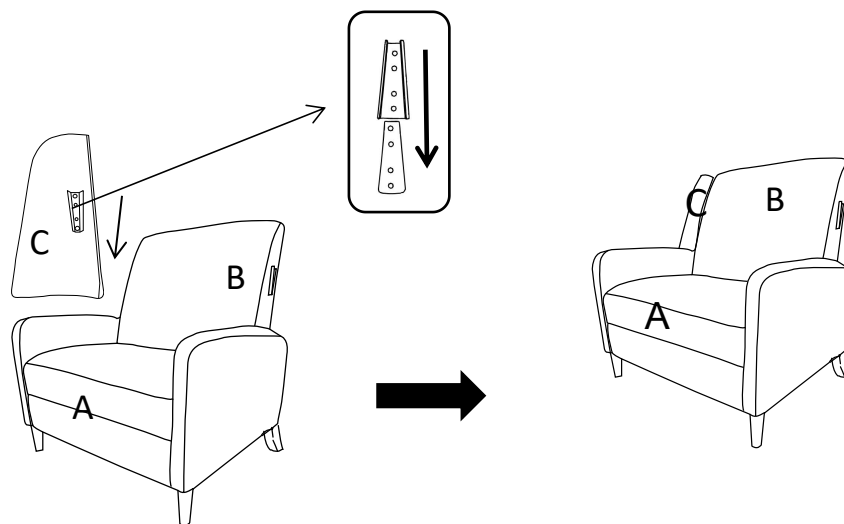

Align the mounting brackets of the Left Wing(C) with those on the left side of the Backrest(B).

Then slide the mounting brackets together until they lock into position as shown above.

Step 6

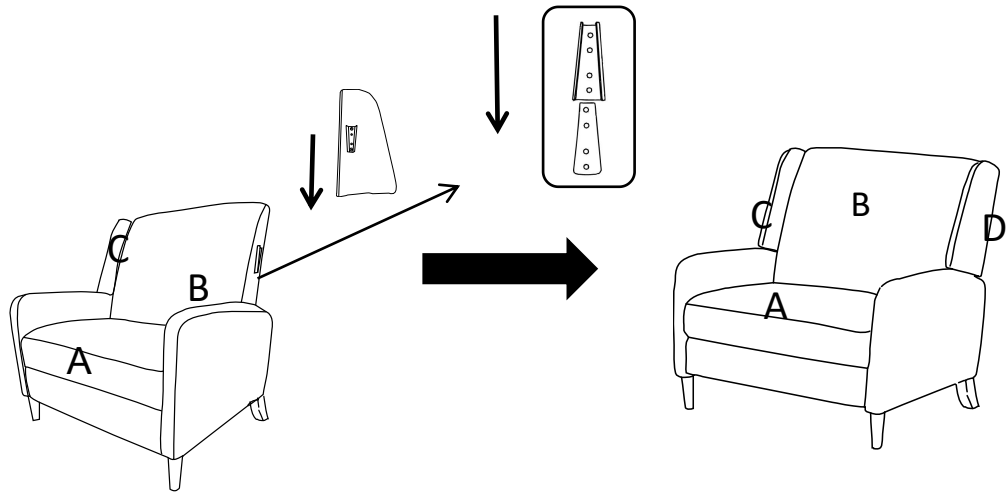

Align the mounting brackets of the Right Wing(D) with those on the right side of Backrest(B).
Then slide the mounting brackets together until they lock into position as shown above.

Step 7

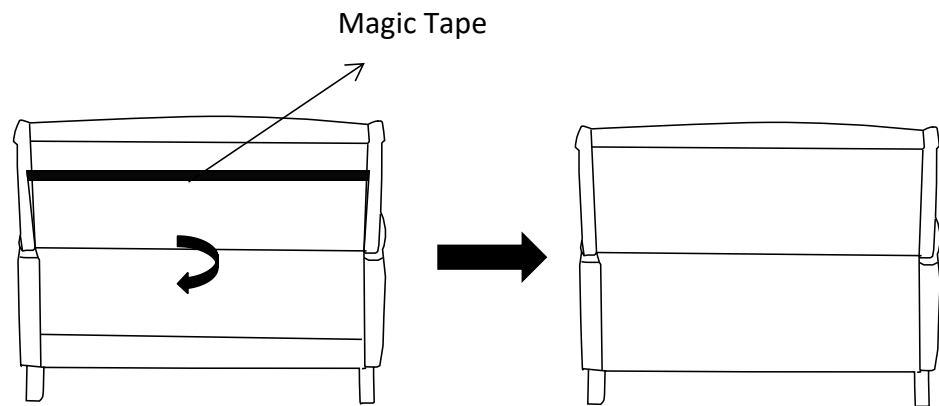

Smooth down the fabric flap on the Backrest(B).
Run your hands down both sides of the flap, from top to bottom, allowing the Magic Tape to adhere to the flap under the seat of the Recliner.

Step 8

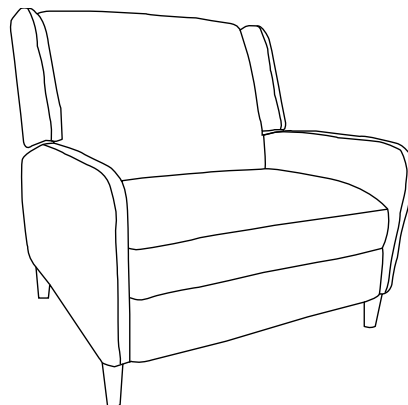

Make sure all parts are connected and securely locked into position.
Your Recliner is ready for use.
This Recliner can only be used on a flat, level surface.

Warning



Correct Way to Use



Incorrect Way to Use



Incorrect Way to Use



Incorrect Way to Use



Incorrect Way to Use



Incorrect Way to Use

Always leave the chair in an upright and closed position after use.
Keep hands and feet clear of the footrest mechanism and any gaps.
Do not allow children to play on the chair.
Do not lean to side to pick up anything while sitting on the chair.
Do not sit on the arms.
Do not stand up when the recliner open.
Only the occupant should operate the chair.

User Instructions

Recliner

Please read the Instruction Manual below carefully before use.

This is a Recliner. At anytime in a reclined seat position or in the upright position, you may enjoy the rocking motion and swivel motion by using your body weight in a back-front rocking motion.

Supervise any children using this Recliner.

To get into the Recline position:

Sit into the seat.

The Chair Backrest will fall down and footrest will open when push the Chair Backrest by your back. So do must put your feet on footrest well when you push down the Chair Backrest.

Use your body weight and push backwards into the seat into a fully reclined position.

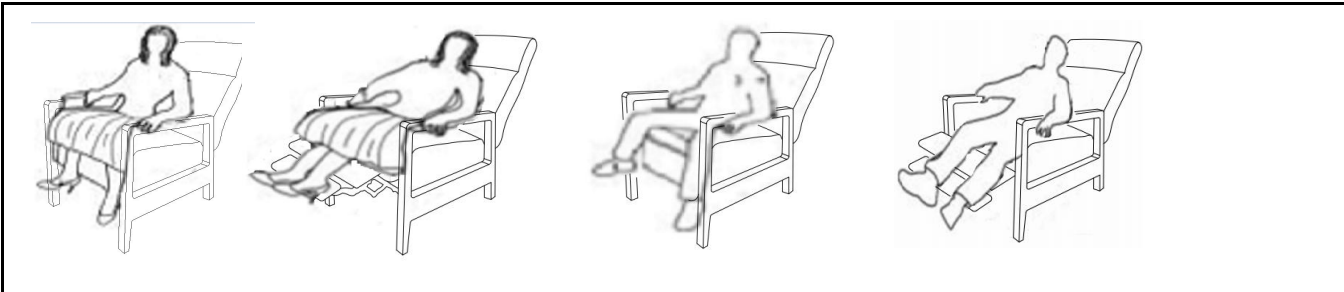





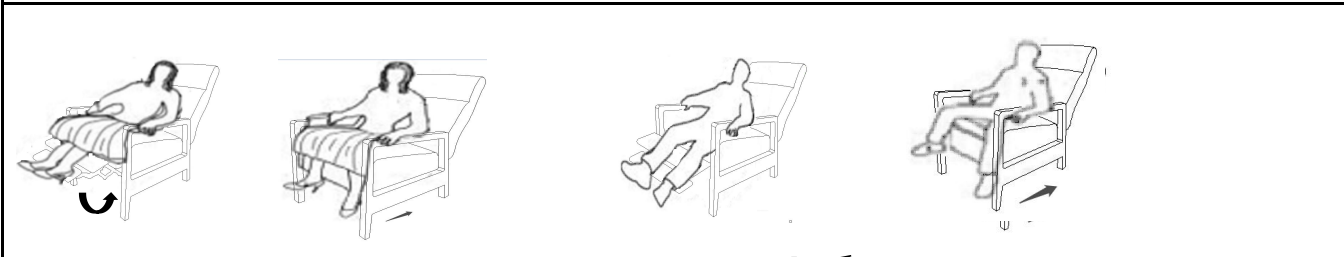





To move the Recliner back into the Upright Position:

Tilt your body weight slightly forward and upwards.
The seat back will come up to an upright position.
Use your feet to push the Footrest down.
The Recliner will automatically lock when it is in the fully upright position.
When necessary, use your arms to help lift/push yourself out of the seat



Care & Maintenance

- ✓  • Furniture may scratch floors. We recommend using furniture pads to protect your floors.
- ⊘  • Do not put hot items directly on furniture surface.
- ⊘  • Do not clean furniture with harsh cleansers or polish.
- ⊘  • Do not place furniture under direct sunlight.
- ⊘  • Do not place furniture near heating or cooling vents.
- ⊘  • Do not write on furniture without a padded barrier to protect the surface.
- ⊘  • Do not place furniture outside . For indoor use only.
- ⊘  • Not for commercial use. For residential use only.
- ⊘  • Stains may be removed with mild soap solution and damp cloth.
- ⊘  • Children should not climb or jump on the furniture.
- ✓  • Dust and pick-up spills using a clean, non-colored, lint-free cloth.

Questions & Answers about Proposition 65

• What is Proposition 65?

Proposition 65 requires businesses to provide warnings to Californians about significant exposures to chemicals that cause cancer, birth defects or other reproductive harm. These chemicals can be in the products that Californians purchase, in their homes or workplaces, or that are released into the environment. By requiring that this information be provided, Proposition 65 enables Californians to make informed decisions about their exposures to these chemicals.

Proposition 65 also prohibits California businesses from knowingly discharging significant amounts of listed chemicals into sources of drinking water.

Proposition 65 requires California to publish a list of chemicals known to cause cancer, birth defects or other reproductive harm. This list, which must be updated at least once a year, has grown to include approximately 900 chemicals since it was first published in 1987.

• What types of chemicals are on the Proposition 65 list?

The list contains a wide range of naturally occurring and synthetic chemicals that include additives or ingredients in pesticides, common household products, food, drugs, dyes, or solvents. Listed chemicals may also be used in manufacturing and construction, or they may be byproducts of chemical processes, such as motor vehicle

• What does a warning mean?

If a warning is placed on a product label or posted or distributed at a workplace, a business, or in rental housing, the business issuing the warning is aware or believes that it is exposing individuals to one or more listed chemicals.

By law, a warning must be given for listed chemicals unless the exposure is low enough to pose no significant risk of cancer or is significantly below levels observed to cause birth defects or other reproductive harm.

• Where can I get more information on Proposition 65?

If you have specific questions on the administration or implementation of Proposition 65, you can contact OEHHA's Proposition 65 program at P65.Questions@oehha.ca.gov, or by phone at (916) 445-6900.