

① × 1

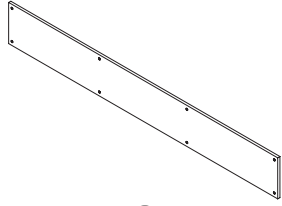

② × 5

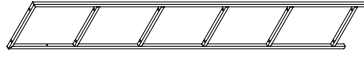

③ × 2



④ × 1

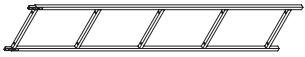

⑤ × 1



⑥ × 2



⑦ × 3

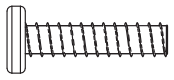

M6×25mm

Ⓐ ×46

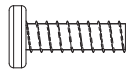

M6×12mm

Ⓑ ×16

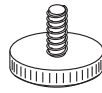

M6×28

Ⓒ ×8

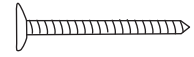

M4×60

Ⓓ ×2

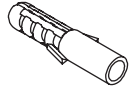

∅ 6x30

Ⓔ ×2



M4

Ⓕ ×1

1

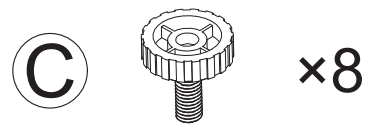
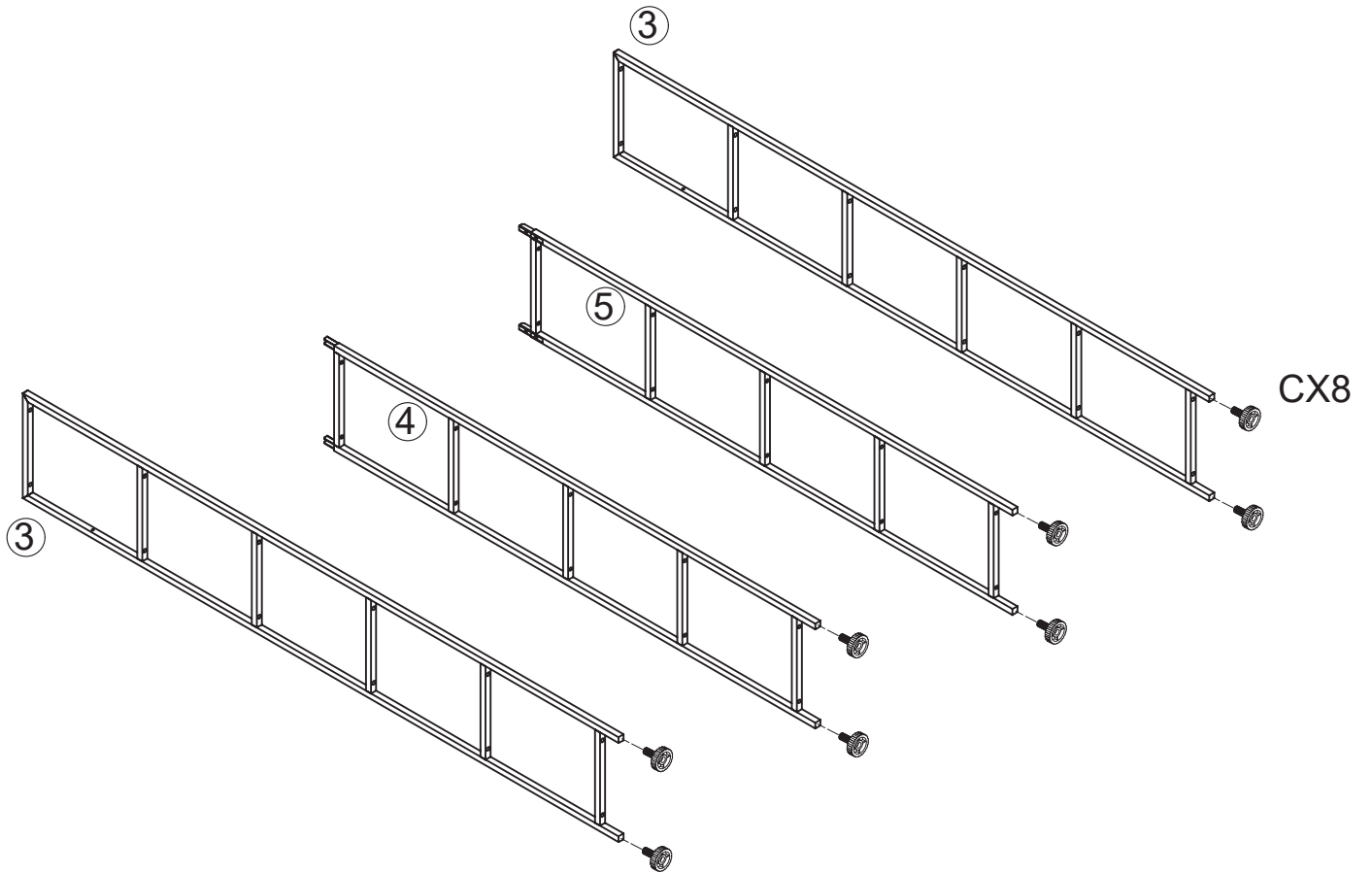

2

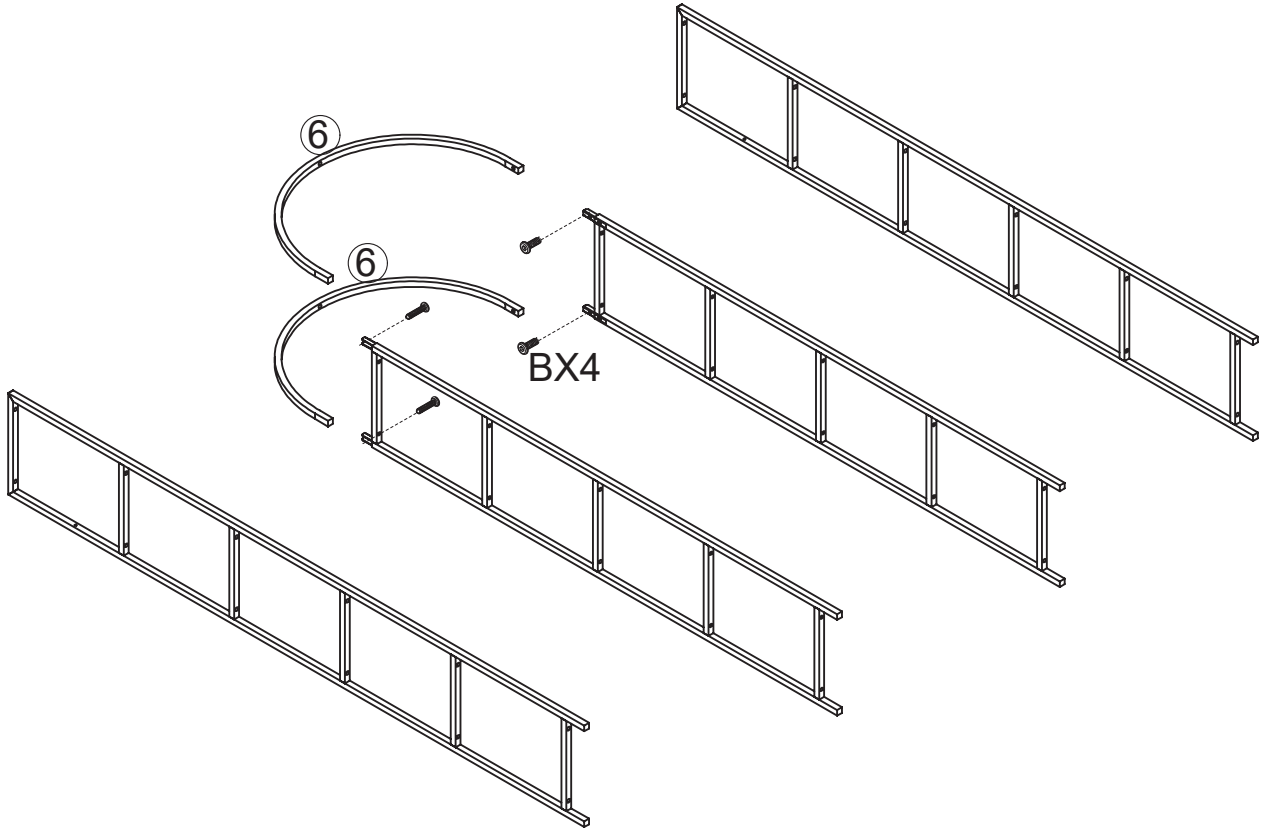

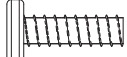
Ⓑ  X4

3

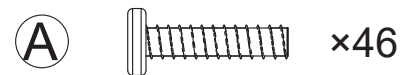
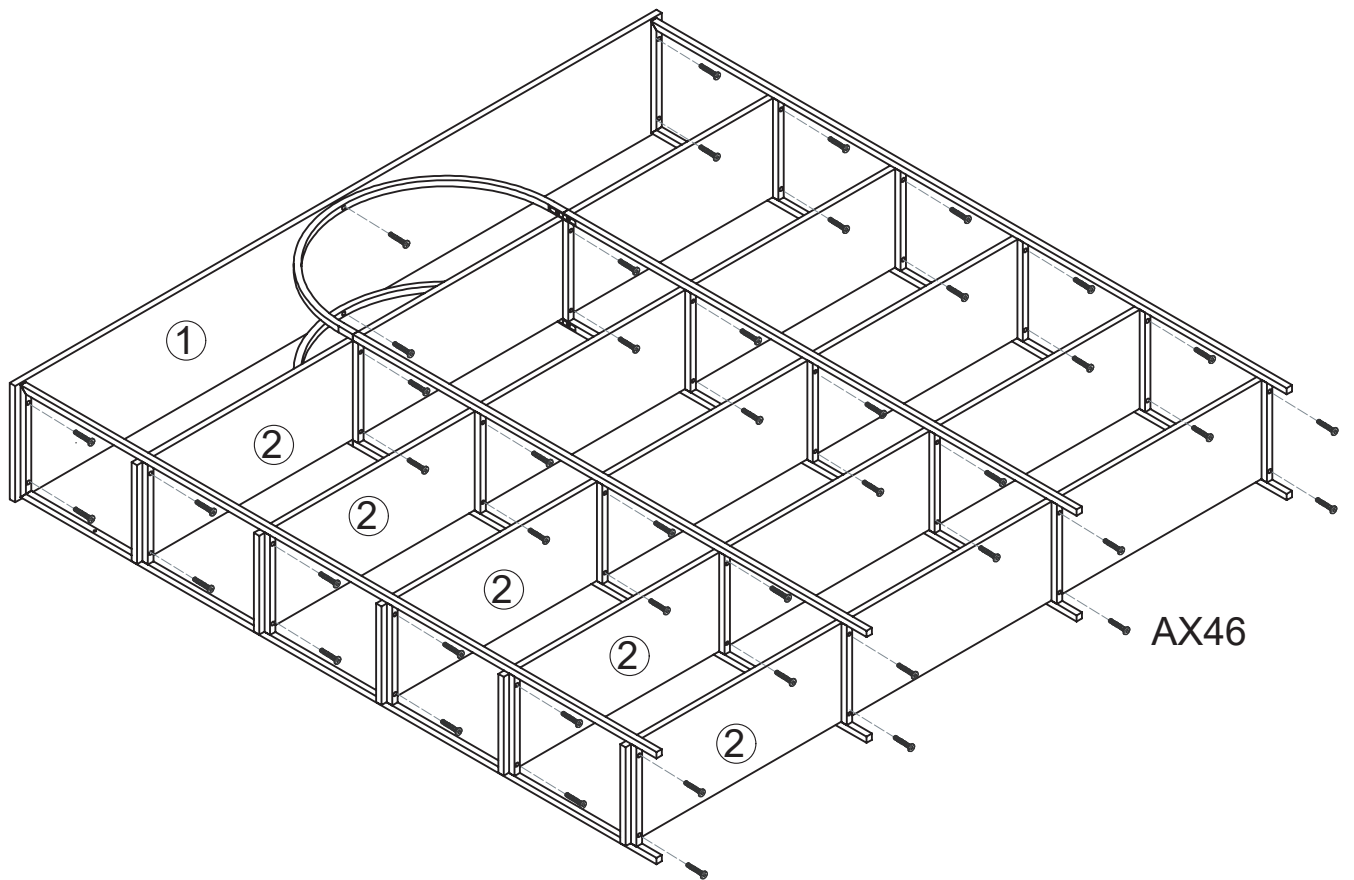

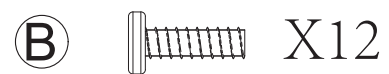
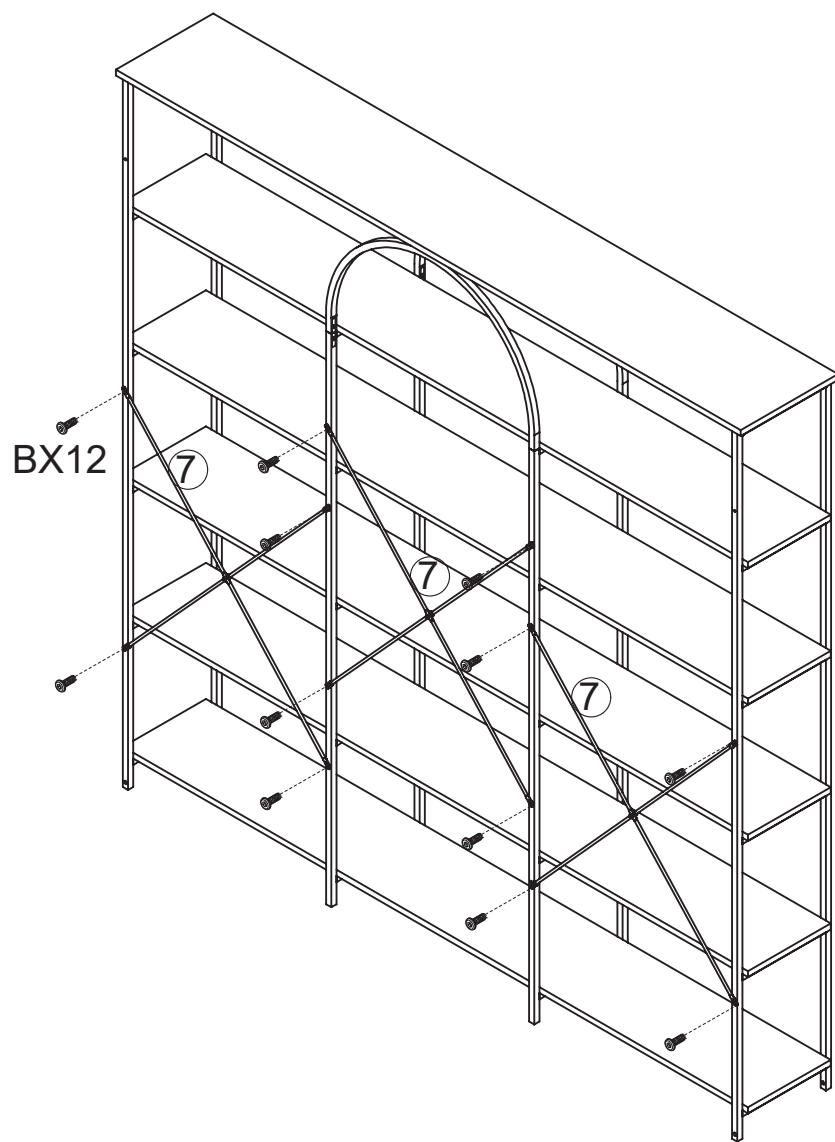

5

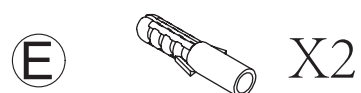
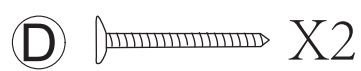
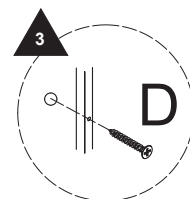
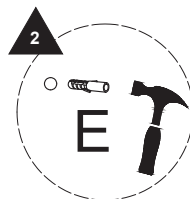
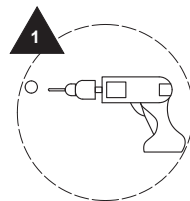
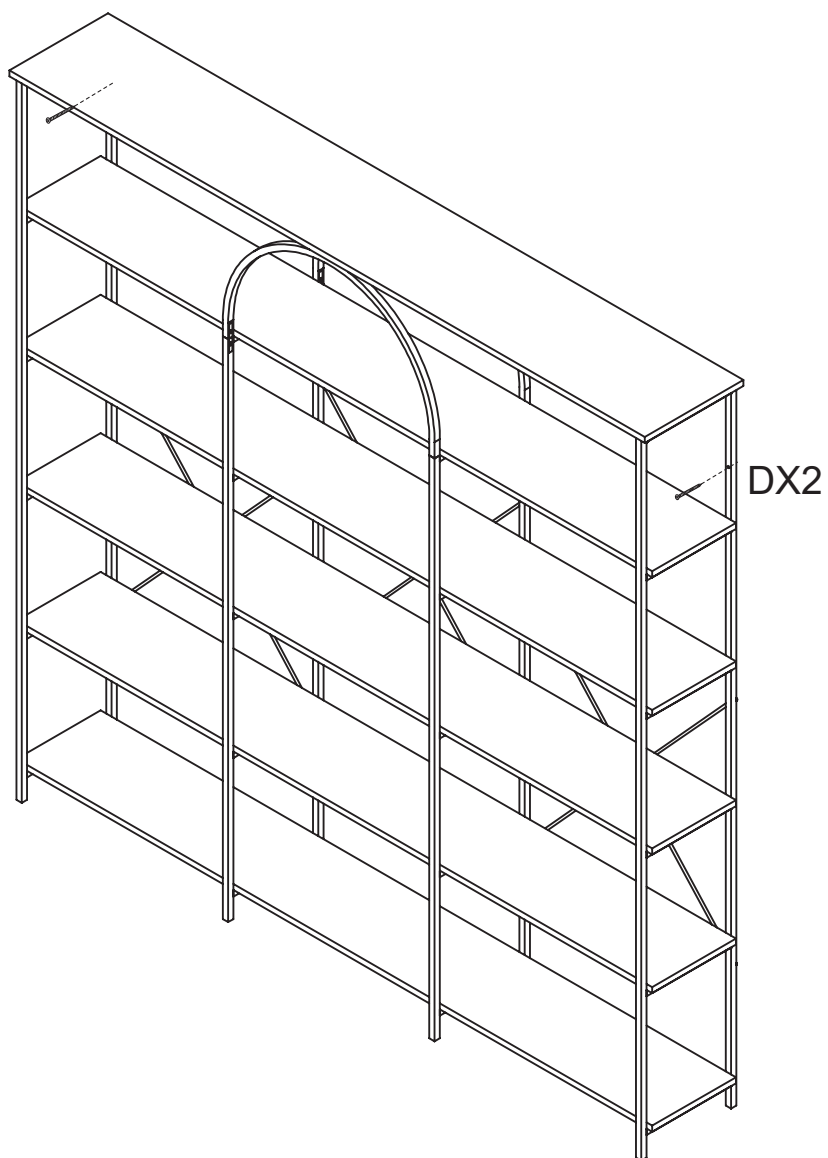

6

