

# **ASSEMBLY INSTRUCTION**

---

## Friendly Reminder:

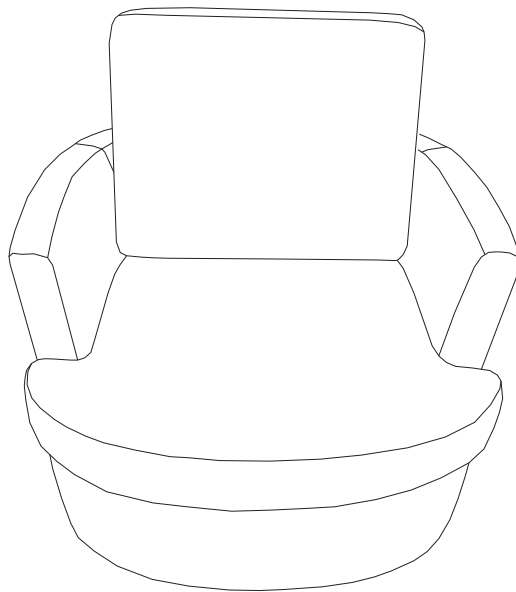









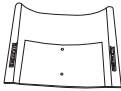

- 1.This sofa is packed in 1 box. Please assemble it After all boxes are received.
- 2.As the cushions are all vacuum compressed,there will be some wrinkles. Please give your cushions up to 72 hours to reach its original size and the wrinkles will basically disappear.
- 3.Please do not open the compressed packags until your sofa frame is completely assembled.



--We strive to offer the highest quality products,and we also try our best to satisfy each and every customer that orders from us with replacement parts or service as needed.

# ASSEMBLY INSTRUCTION

## PARTS LIST

NO.	DESCRIPTION	SKETCH	QTY
A	Seat cushion		1
B	Back frame		1
C	Left armrest		1
D	Right armrest		1
E	Seat frame		1
F	Back cushion		1
G	Board		1
H	Rotating tray		1
J	L-shaped Iron		3
L	Screws 8x45		12
M	Screws 6x40		4
O	Washer		16
P	Wrench		1



# ASSEMBLY INSTRUCTION

---

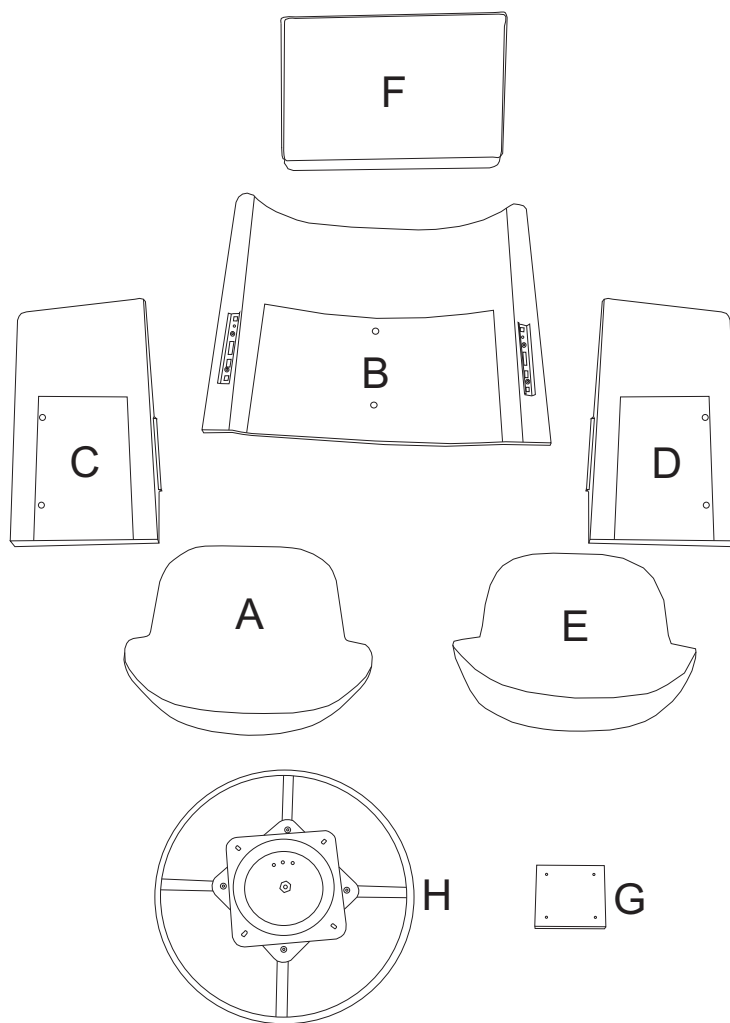
All parts and hardwares.



# DIAGRAM 1

J		3PCS
L		6PCS
O		6PCS

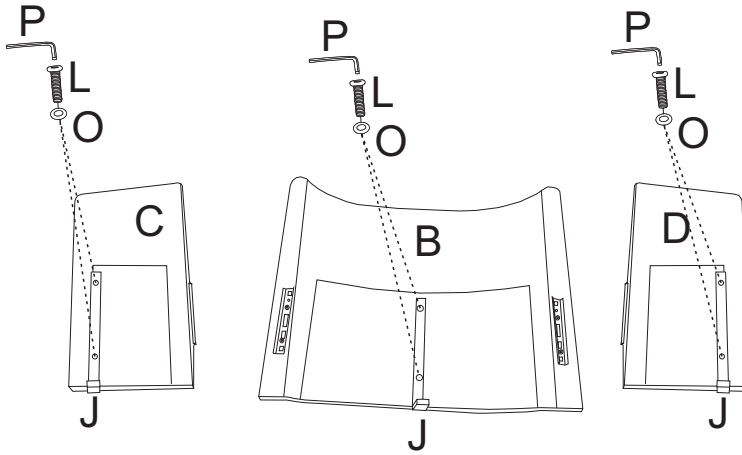

# DIAGRAM 2

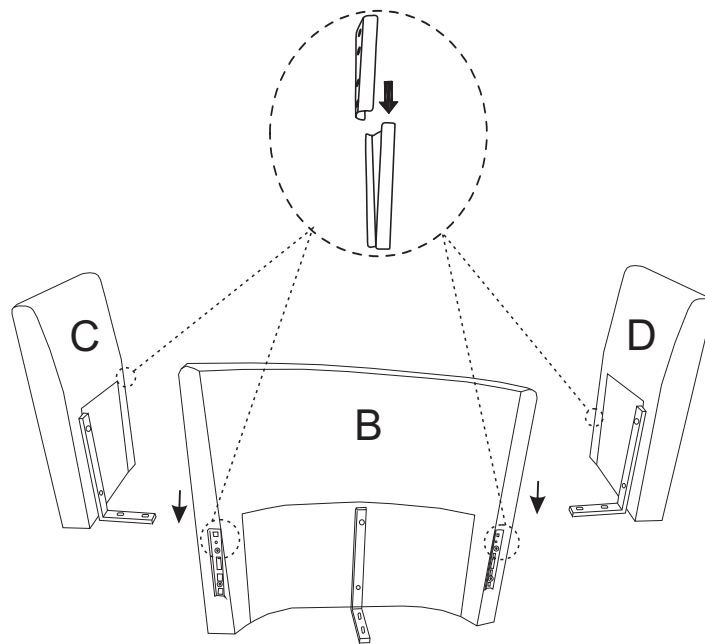

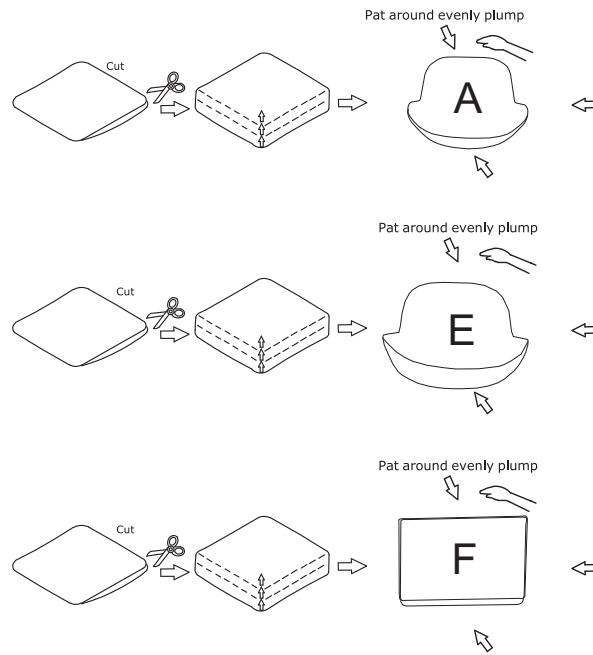

### DIAGRAM 3



**Tips:**

1. Please do not open the compressed packages until your sofa frame is completely assembled.
2. Compressed back cushions and pillows need to be fully fulfilled within 72 hours for your perfect use.
3. Please keep children away from plastic bags or any small pieces of stuff.

### DIAGRAM 4

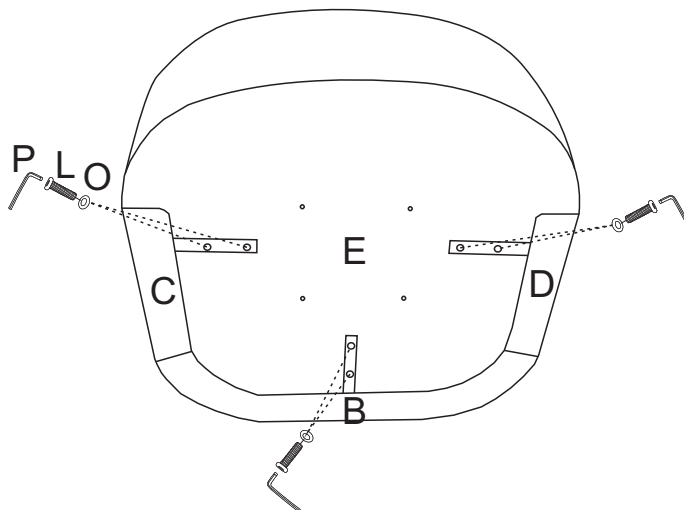

O		6PCS
L		6PCS



**Note:** Lock the back panel first and then lock the left and right armrests, do not lock it completely, and then tighten it after all the screws are locked.

**Sequence:** B C D

**DIAGRAM 5**

O		4PCS
M		4PCS

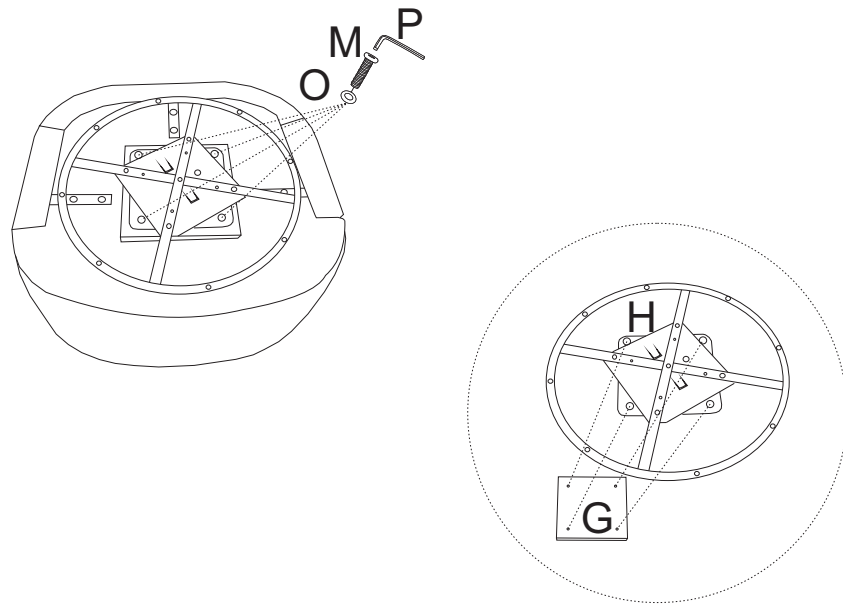

**DIAGRAM 6**

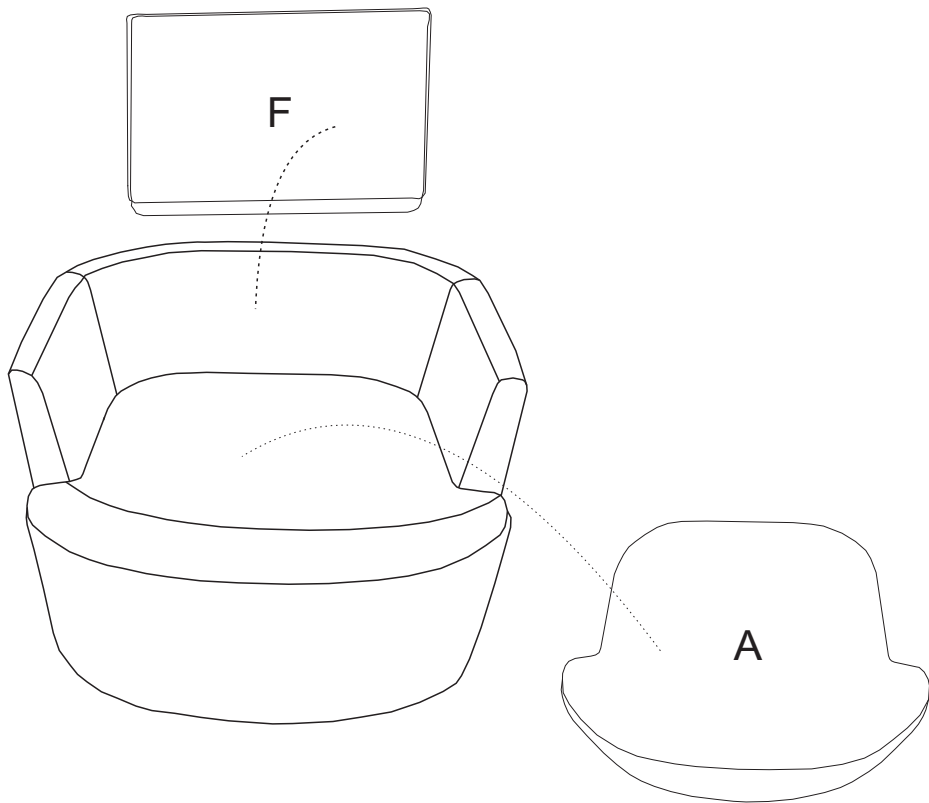

**COMPLETE**

