

INSTALLATION MANUAL

MIRROR SHOE(STORAGE) CABINET

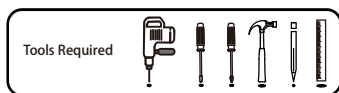
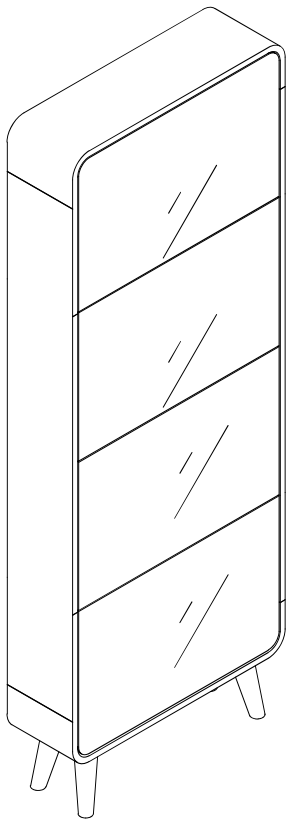

updated on 08/28/2024

SUMMARY

INTRODUCTION page 3

TIPS AND WARNINGS page 4

PARTS LIST page 5

INSTALLATION STEPS page 7

INTRODUCTION

Before using the product ,please read this manual carefully and then assemble it.

To avoid any injury or damage to the product,please follow below safety rules.

- Product to be installed in a dry,flat place indoor.
- Assembly & movement: minimum 2 adults - heavy and fragile product.
- Make sure all screws in the part list included in the hardware package before assembly.
- In the event of a missing items,contact the seller within 48 hours of receiving the product.

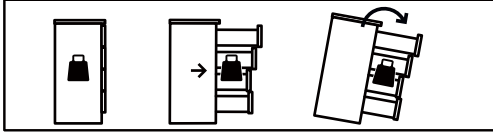

English

WARNING

Serious or fatal crushing injuries can occur from furniture tip-over.

ALWAYS secure this furniture to the wall using tip-over restraints.

To further reduce the risk of serious injury and death from tip-overs:

- Place heaviest items in the lower drawer.
- Do not set TVs or other heavy objects on top of this product.
- Never let children climb or hang on drawers, doors, or shelves.

■ ATTENTION ■

This product is for household use only! And not for commercial use.

Do not use this product for any other over expected purpose. To any commercial use, public or institutional, disclaims all liability and cancels all guarantees.

TIPS AND WARNINGS:

- Do not lean on the shoe cabinet.
- Do not store in a damp room or outdoor.
- Beware of the risks of pinching and puncturing during installation.
- Beware of the risk of mirror damage.













Maintenance :









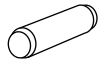



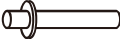



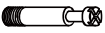

Cleaning with a dry cloth.

Far away from water or wet shoes.

PART LIST

Illustration picture for reference only

| NO. | DESCRIPTION | QTY | SIZE | ILLUSTRATION |
|-----|-------------------|-----|---------------|---|
| ① | Left Side panels | 1 | 1415x194x15mm |  |
| ② | Right Side panels | 1 | 1415x194x15mm |  |
| ③ | Top panel | 1 | 630x194x15mm |  |
| ④ | Bottom panel | 1 | 630x194x15mm |  |
| ⑤ | Back slotted slat | 2 | 600x76x12mm |  |
| ⑥ | Back slotted slat | 2 | 600x198x12mm |  |
| ⑦ | Back panels | 3 | 600x343x5mm |  |
| ⑧ | Mirror door | 1 | 595x379x12mm |  |
| ⑨ | Mirror door | 1 | 595x379x12mm |  |
| ⑩ | Mirror door | 2 | 595x379x12mm |  |
| ⑪ | Mirror door slat | 4 | 585x128x12mm |  |
| ⑫ | Mirror door slat | 4 | 585x80x12mm |  |
| ⑬ | Solid wood feet | 4 | 150mm |  |
| ⑭ | Wooden mortise | 8 | ∅ 8x40mm |  |

| NO. | ILLUSTRATION | QTY | SIZE |
|-----|---|-----|------------|
| 15 |  Left shoe rack | 4 | |
| 16 |  Right shoe rack | 4 | |
| 17 |  | 8 | |
| 18 |  | 8 | |
| 19 |  | 16 | Ø 3.5x10mm |
| 20 |  | 8 | Ø 3.5x14mm |
| 21 |  | 24 | Ø 3.5x16mm |
| 22 |  | 28 | |
| 23 |  | 28 | |
| 24 |  anti-falling | 2 | |
| 25 |  anti-falling | 4 | |
| 26 |  anti-falling | 2 | Ø 3.5x14mm |
| 27 |  anti-falling | 2 | Ø 3.5x25mm |
| 28 |  anti-falling | 2 | |
| 29 |  | 4 | Ø 8x30mm |
| 30 |  | 2 | Ø 4x45mm |
| 31 |  | 4 | |
| 32 |  | 4 | Ø 3.5x14mm |
| 33 |  | 4 | Ø 3.5x35mm |

INSTALLATION STEPS

Please read the instructions carefully before assembling the cabinet.

Two adults are required for assembly of this product on a clean, flat surface instead of a rough surface.

STEP 1

Assemble 4 mirror door to tipping bucket

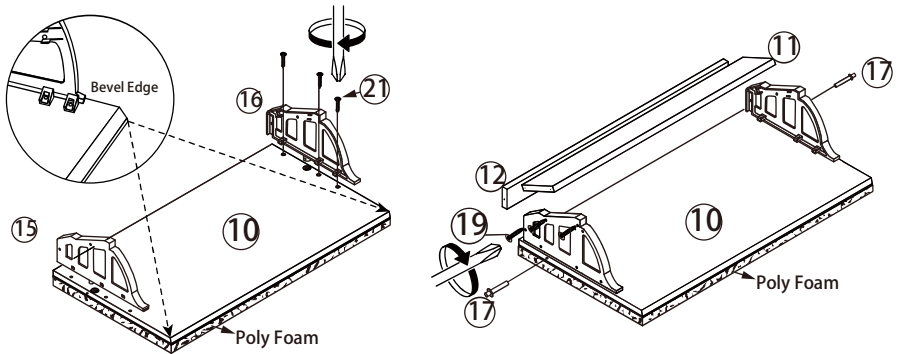

Attention:
Please protect mirror with polyfoam.

STEP 2

Screw on the side panels

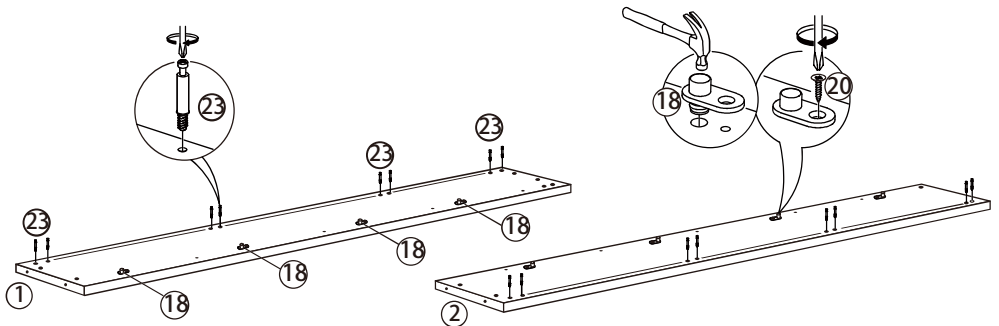

STEP 3

Insert the wood pin and screws install the bottom slats.

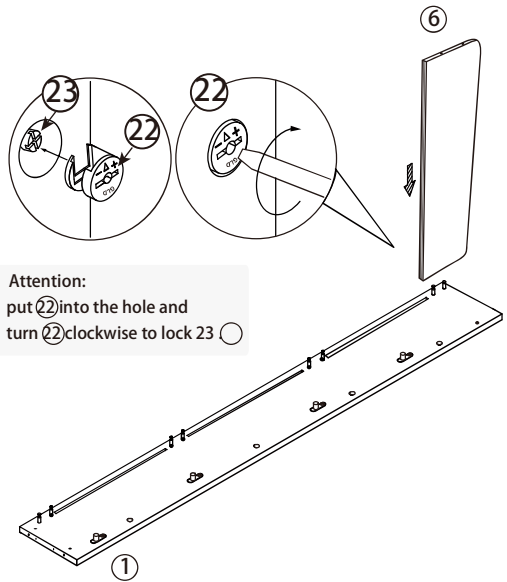

Attention:
put 22 into the hole and
turn 22 clockwise to lock 23

Attention:
Make sure back panels fall into the slots.

STEP 4

Insert 3 pcs back panel make sure panels fall into the slots.

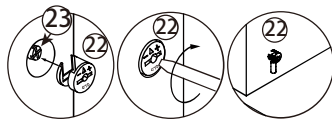

Attention:
put 22 into the hole and
turn 22 clockwise to lock 23

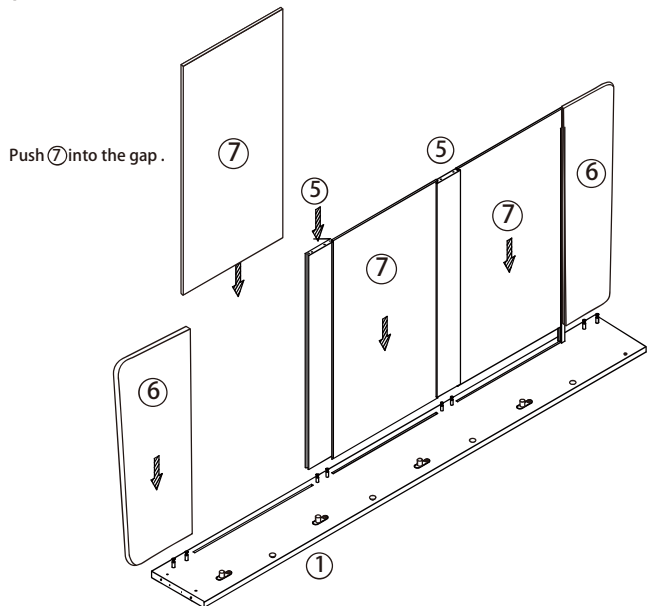

STEP 5

Insert tipping bucket to side panels

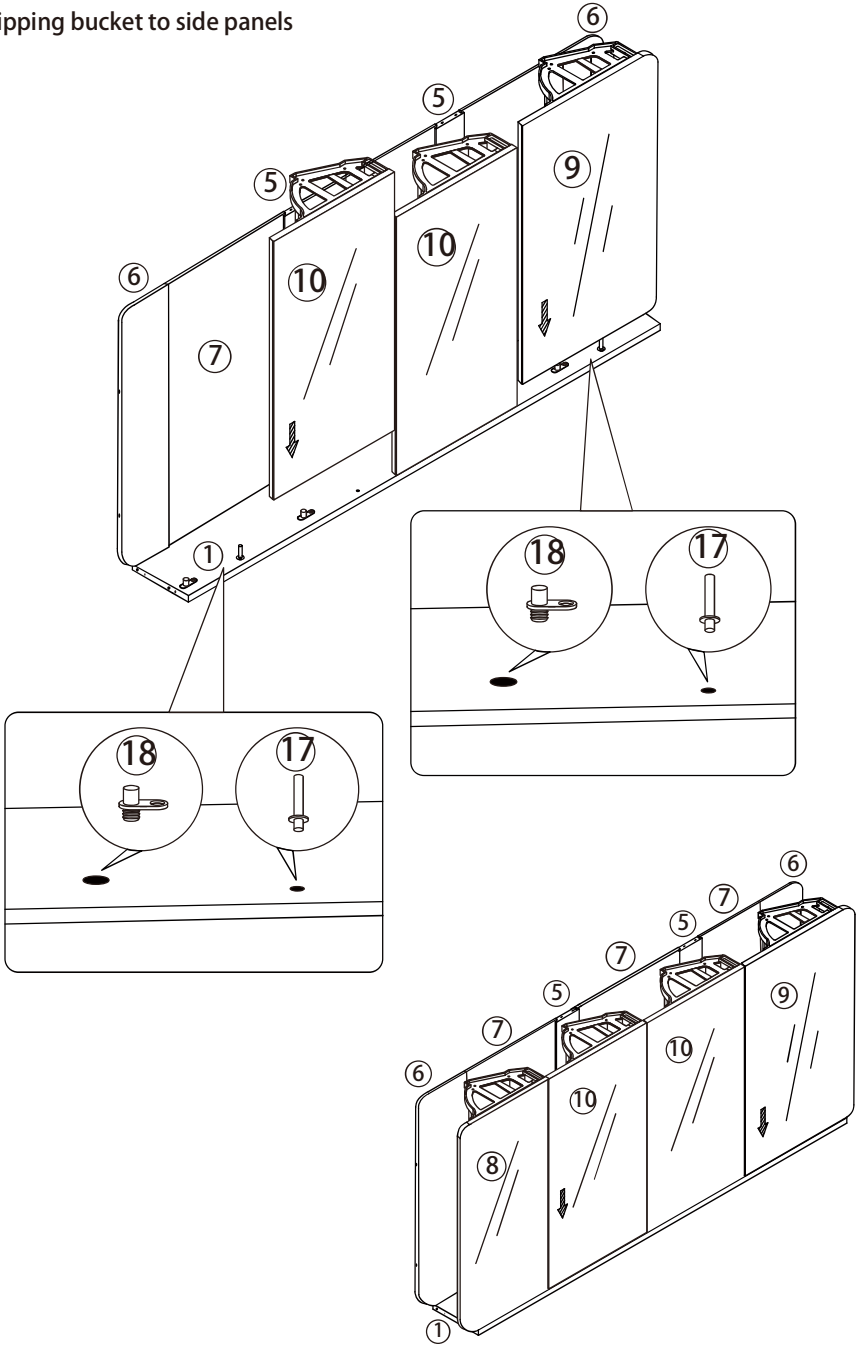

STEP 6

Insert side panel on the top panel

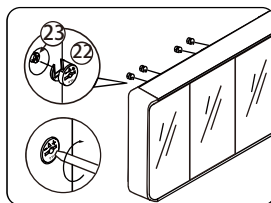
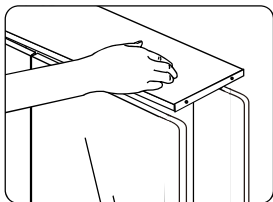

Attention:

Make sure side panel fall into slots, if the side panel is not fully fit, please tap the side panel tightly to adjust.

Attention:

Make sure all screws locked tightly.

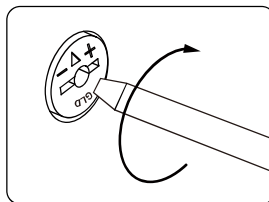
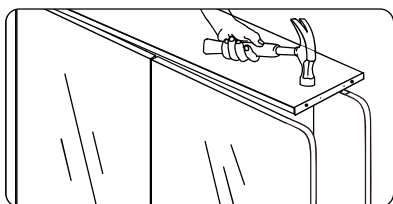

Attention:

put 22 into the hole and turn 22 clockwise to lock 23.

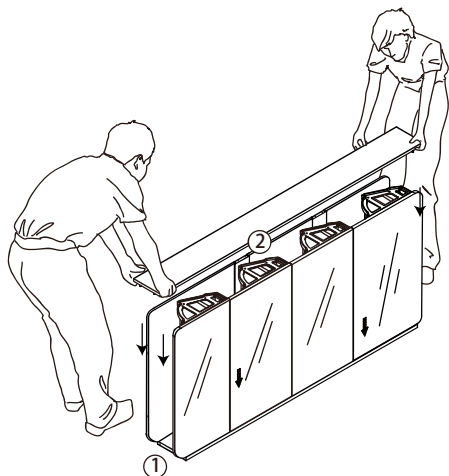

Attention:

Insert 14 into the hole first.

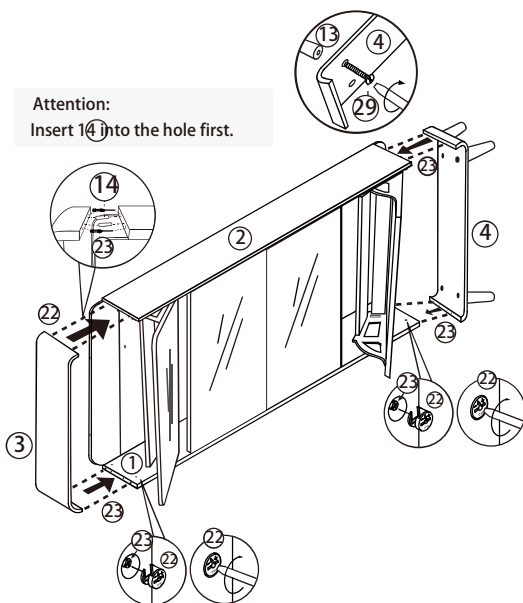

ATTENTION

Place the installed shoe cabinet flat on the ground then raise it up using two people. Mirror must on the top when you raise it up. Do not let the moveable door panel fall off.

STEP 7

Lift the shoe cabinet and straighten it

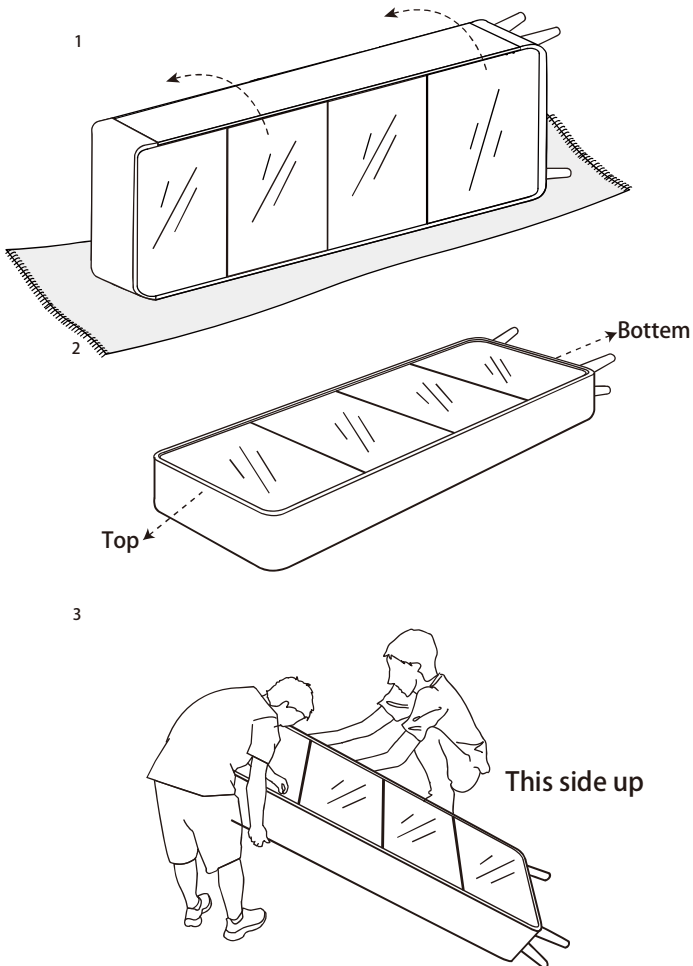

STEP 8

Install the anti-falling screws

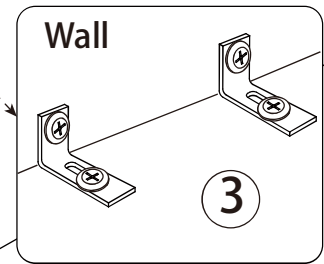
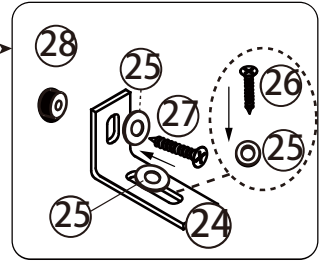
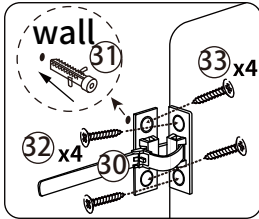
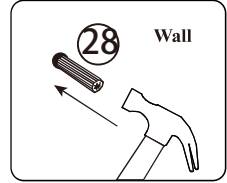
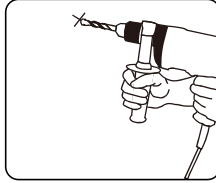
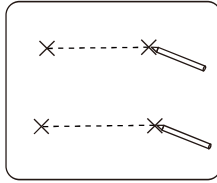
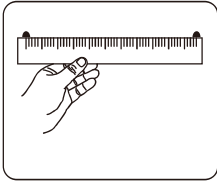

320mm

1718mm

WARNING

To reduce the risk of furniture Tip over”
ALWAYS install anti-tip device provided
-NEVER allow children to stand,
climb or hang on drawers.