

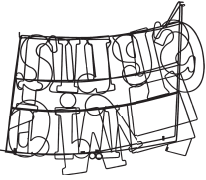

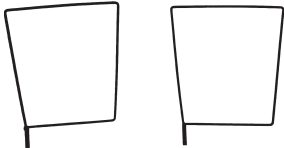

-
- Read entire assembly manual, paying special attention to the important tips and safety information .
 - Ensure there are no missing pieces by first separating and identifying all parts.
 - Make sure to check packing material for small parts that may have fallen out during shipment.
 - Structures are not intended for public use. The Company does not warranty any of its residential structures subjected to commercial use such as: Daycare, Preschool, Nursery School, Recreational Park, or any similar Commercial Application.
 - This manual contains helpful information concerning assembly preparation, installation procedure and required maintenance.
 - Always keep safety in mind as your structure is being built.
 - Keep these instructions for future reference.

5.9FT CHRISTMAS SIGN

Part	Description	Illustration	QTY
A	Sign		1
B	Gift boxes		2
C	Holy leaf		1
D	Stander		1
E	Latch		
F	Plastic tie		
G	Ground stake		

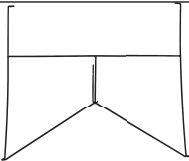
MAKE SURE TO FOLLOW THE STEPS BELOW
FOR A SUCCESSFUL & EASY ASSEMBLY

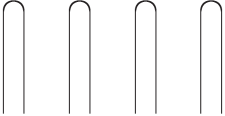
TIP: To ensure the final unit is secure and sturdy it is highly recommended to secure each component with the zip ties provided after connecting each component together in the steps.

TO ASSEMBLE

1. Remove all components from the box and lay flat on the floor.

NOTE: Some parts are connected by a string of lights and should NOT be separated. Any separation or disconnection of the light set may cause the unit to malfunction or not light completely.

2. Connect two half of the Sign(A). (see Fig.1)

(a) Insert the prong into the corresponding metal cylinder and secure them with the latch(E).

NOTE: Fully insert the latch(E) to the hole.

(b) Insert the prong into the corresponding metal cylinder.

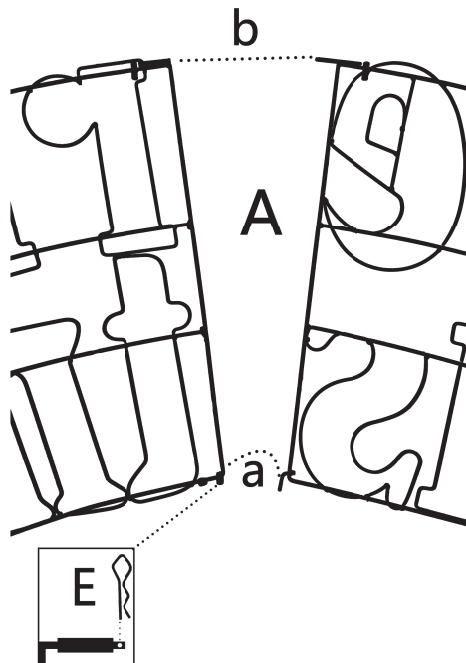

Fig.1

3. Connect the Stander(D) to the Sign(A). (see Fig.2)

(a) Expand the Stander(D) and insert the hook to the corresponding metal cylinder of the Sign(A).

(b) Hook the rod of Stander(D) to the corresponding ring of the Sign(A).

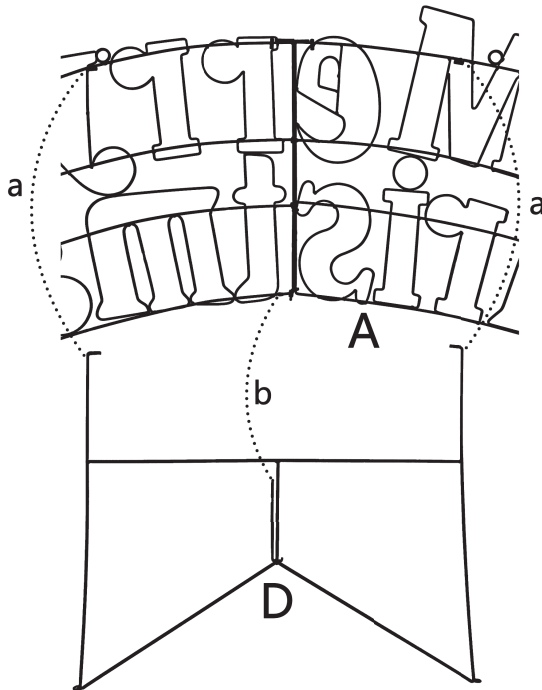

Fig.2

4. Insert the metal post of Gift boxes (B) into the corresponding metal cylinder of the Sign(A).(see Fig.3)
5. Insert the metal post of the Holy leaf (C) into the corresponding metal cylinder of the Sign(A).(see Fig.3)
6. Secure the installing points with plastic ties (F) and secure the base to the soft ground by fully inserting the ground stakes (G) into the ground.(see fig.3)

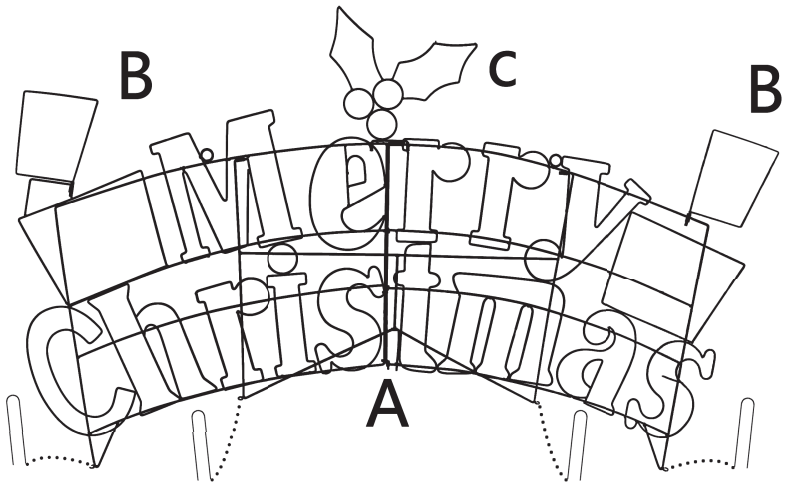

Fig.3

7. Connect the plug to the extension cord and plug the light set into a standard 120-volt AC electrical outlet.

ENJOY YOUR PRODUCT!



⚠️ WARNING

Manufacturer and seller expressly disclaim any and all liability for personal injury, property damage or loss, whether direct, indirect, or incidental, resulting from the incorrect attachment, improper use, inadequate maintenance, or neglect of this product.