

# Armchair

Complete drawing display

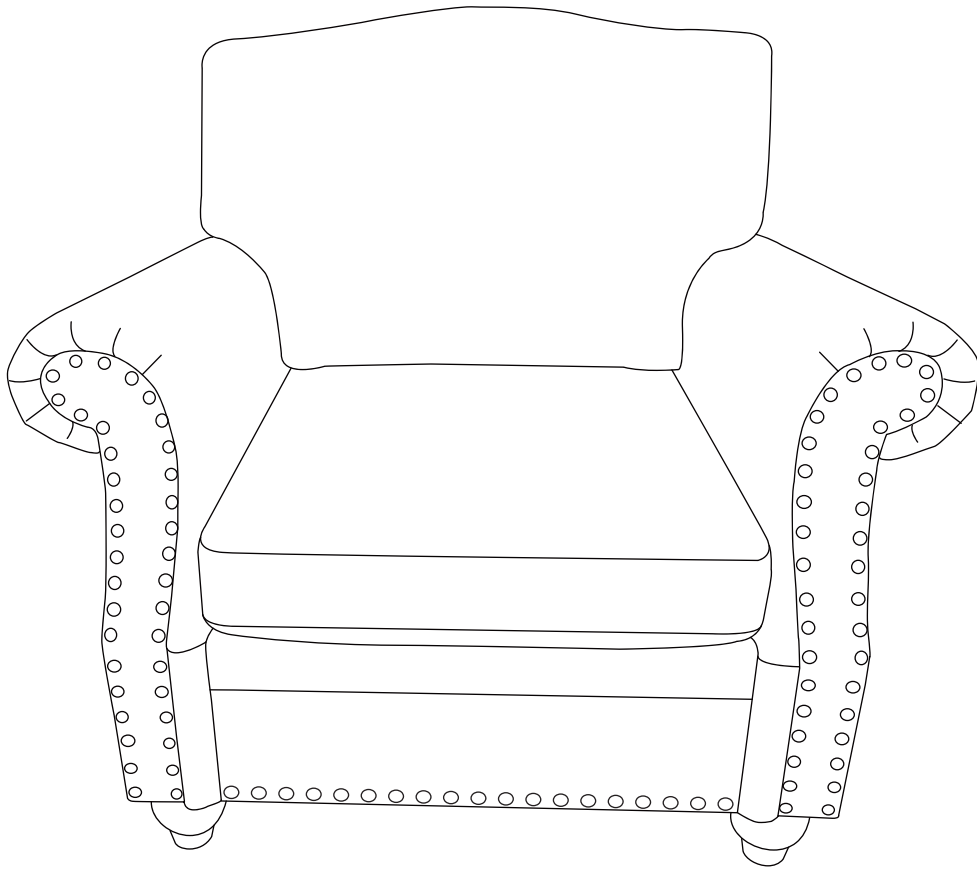

# Safety And Care Advice

Important - Please read these instructions carefully before installing

Thank you very much for purchasing the product.

To use this product safely and correctly, please read these instructions carefully. After reading these instructions, keep this manual in a safe place for future reference.

Although this product is expected to be complete and safe, please check that all accessory items are included before attempting to assemble the product.

If you find anything in the instruction manual that is difficult to understand, or if you find a defect with the product, stop using it immediately and contact Customer Service.

## Warnings :

Children are not allowed to assemble the product. During assembly, keep all small parts out of the reach of children as they may be fatal if swallowed or inhaled.

Do not place in front of a fire or other heat source.



After-sales  
service



Fast installation



Teamwork  
Recommended



The product parts are packed in two separate cartons. Please wait to receive both complete cartons before proceeding with the installation.

## Maintenance and Cleaning Methods

**Regular Wiping:** Use a soft, damp cloth to wipe down the PU leather sofa regularly to remove dust and spills. This helps prevent dirt buildup and maintains the sofa's appearance.

**Avoid Harsh Chemicals:** Refrain from using harsh chemicals or abrasive cleaners on PU leather, as they can damage the material's finish. Stick to mild soap and water for cleaning, and always test any new cleaner on a small, inconspicuous area first.

**Protect from Sunlight:** Position the PU leather sofa away from direct sunlight and heat sources to prevent fading and drying out of the material. Consider using curtains or blinds to shield the sofa from intense sunlight during peak hours.

**Handle with Care:** Be gentle when using the sofa, avoiding sharp objects or rough surfaces that could scratch or puncture the PU leather. Encourage family members and guests to be mindful of their actions to prevent accidental damage.

**Conditioning (Optional):** While PU leather doesn't require conditioning like genuine leather, you may choose to use a specialized PU leather conditioner occasionally to maintain its suppleness and prevent cracking. Follow the product instructions carefully and apply sparingly.

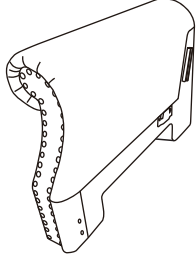
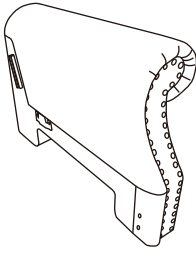
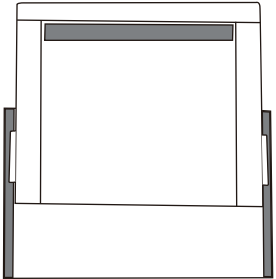
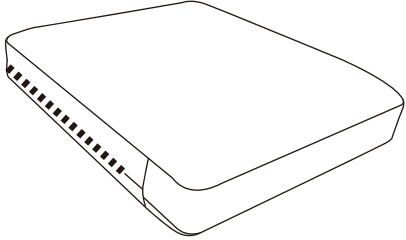
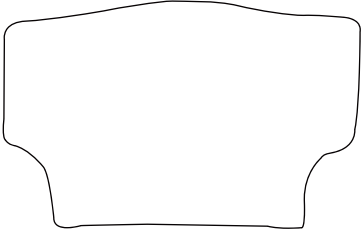

# Parts List

The parts list is shown below

illustration	description	quantity
	Left armrest	J-L X1
	Right armrest	J-R X1
	Backrest	K X1
	Seat cushion	M X1
	Bolster	N X1

# Parts List

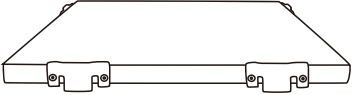
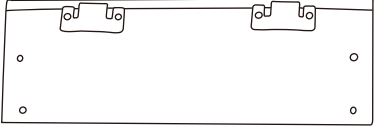
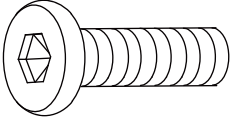
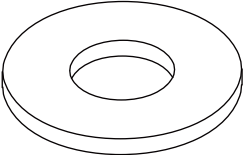
The parts list is shown below

illustration	description	quantity
	Seat Frame	O X1
	Seat Frame Front Panel	P X1
	M8 x 20mm Screw	A X8
	Washer	B X8
	Allen Key	C X1

# Parts List

The parts list is shown below

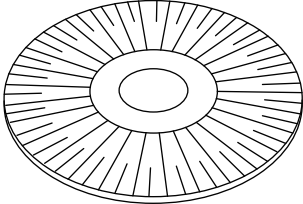
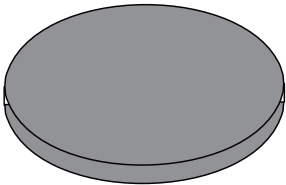
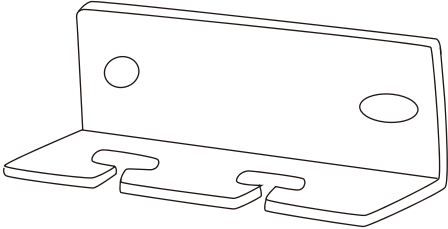
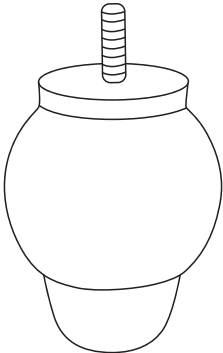
illustration	description	quantity
	Anti-slip washer	D X4
	Felt pad	E X4
	Angle Bracket	G X2
	Wooden leg	H X4

# Installation Procedure

Specific operations are shown in the following figure

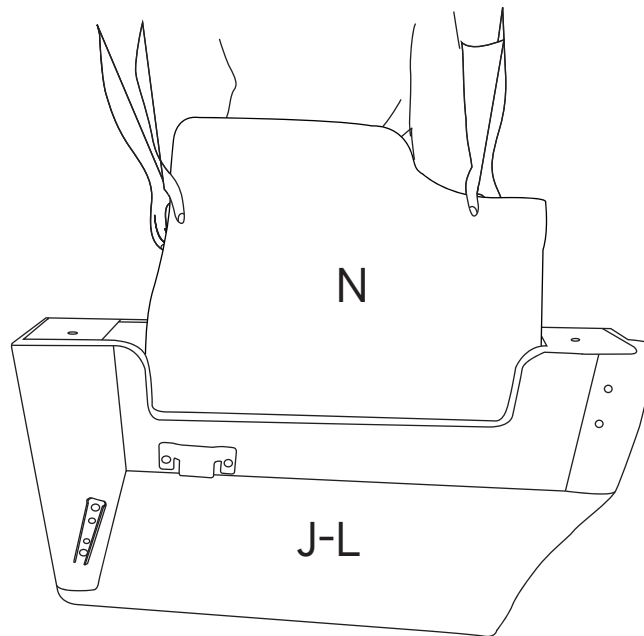

STEP: Remove the bolster from inside the armrest.

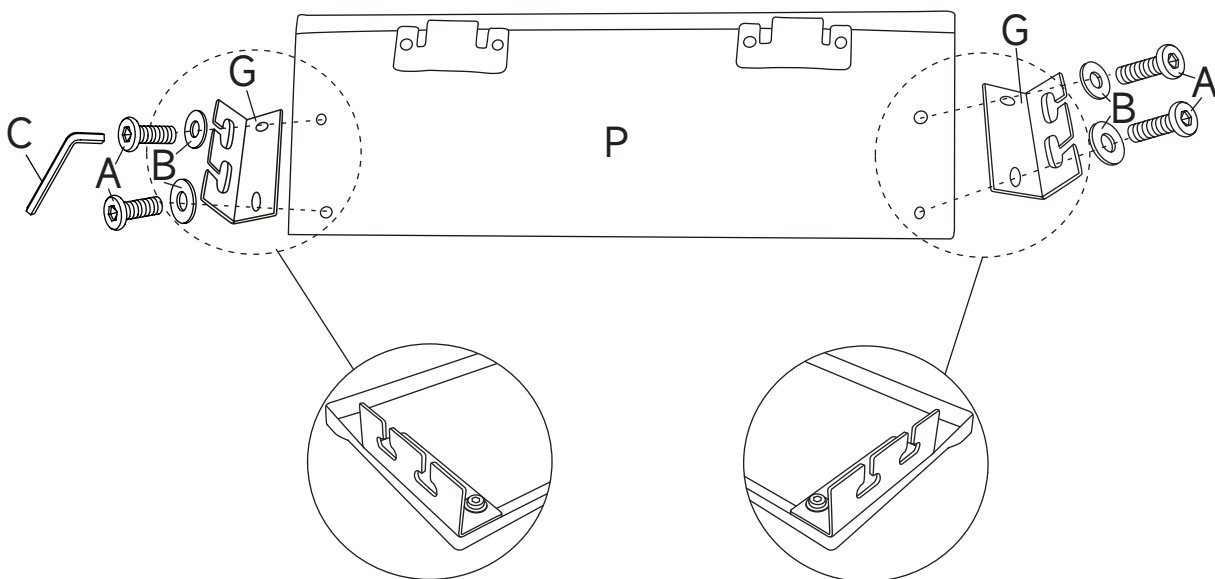
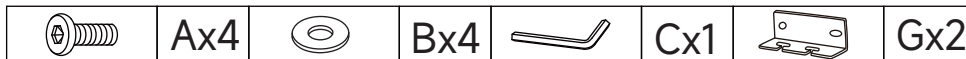

STEP: Assemble the components by inserting the screw (with a washer) through the aligned holes of the angle iron and the seat frame front panel, then secure with a nut and washer on the opposite side and tighten firmly using a hex key.

# Installation Procedure

Specific operations are shown in the following figure

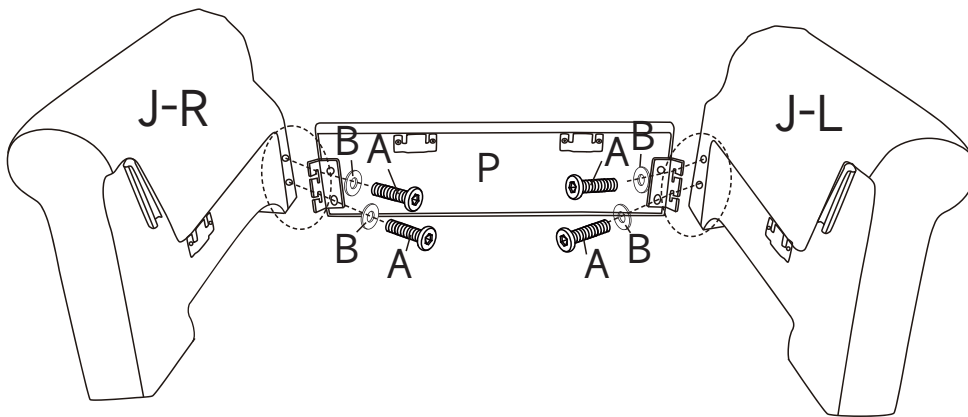
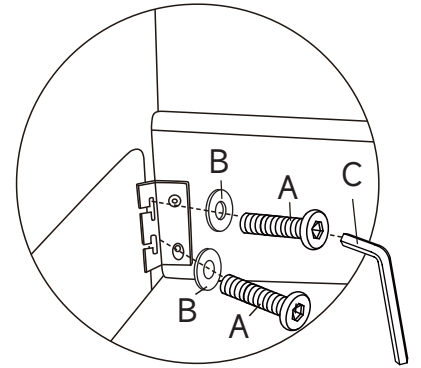

**STEP:** Position the seat frame front panel and the two armrests into their correct orientation. Then, connect and secure them together by inserting and tightening the remaining screws through the corresponding mounting holes.

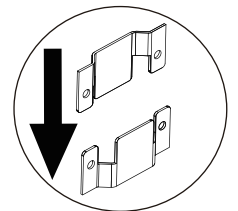
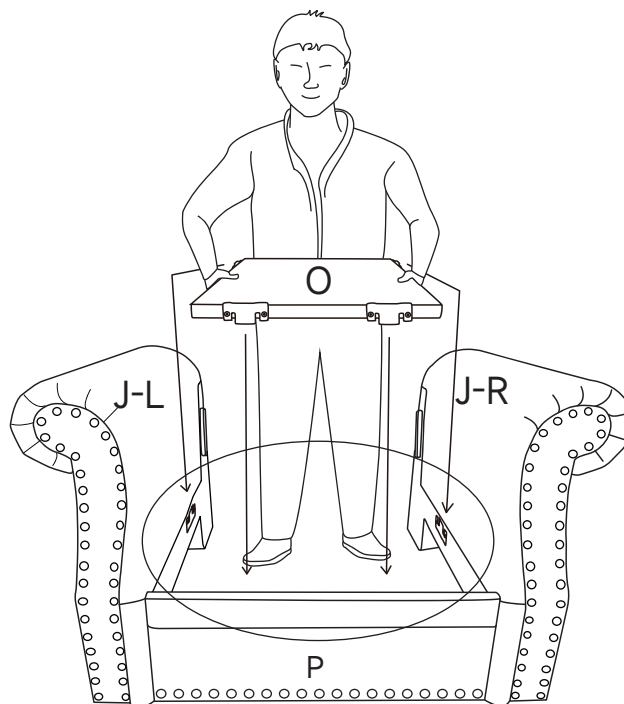

**STEP:** Following the orientation in the diagram, align the male tabs on the seat frame with the corresponding female slots on the base, then carefully lower the frame into place.

# Installation Procedure

Specific operations are shown in the following figure

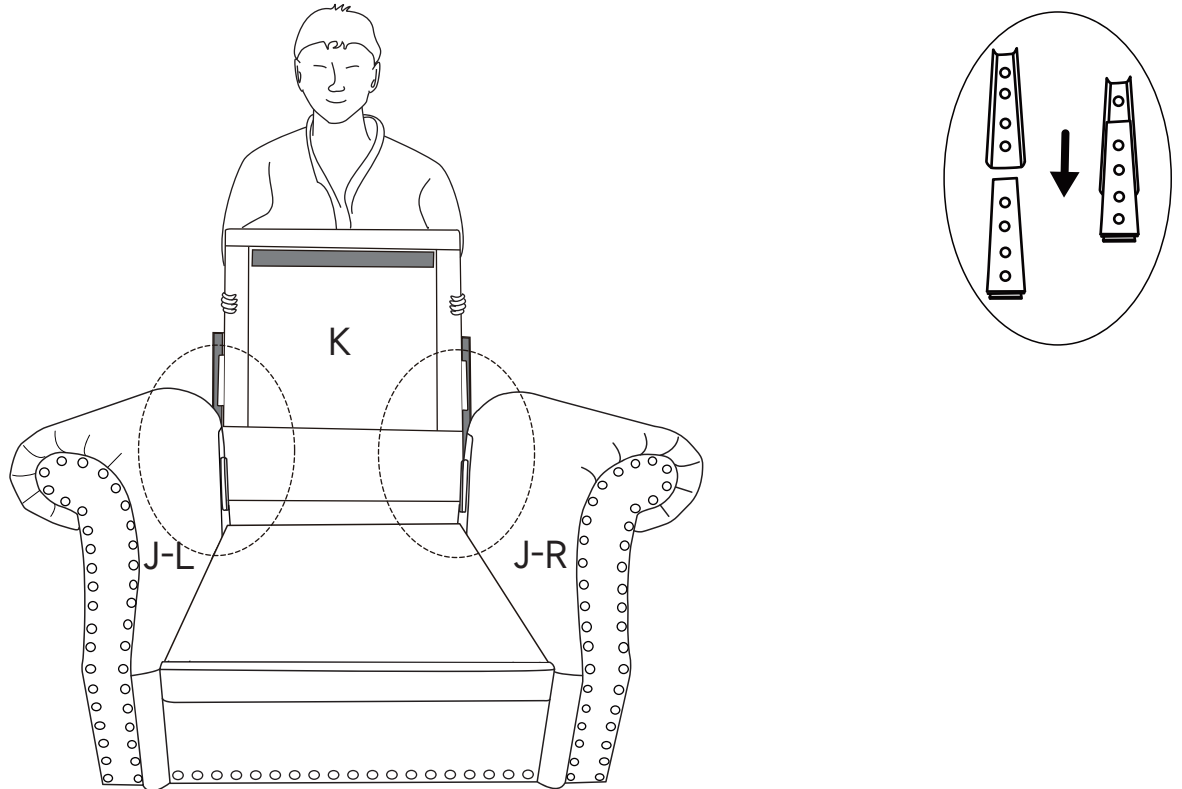

**STEP:** Holding the backrest in the orientation shown, align its tabs with the slots on the armrests and press down firmly until it clicks securely into position.

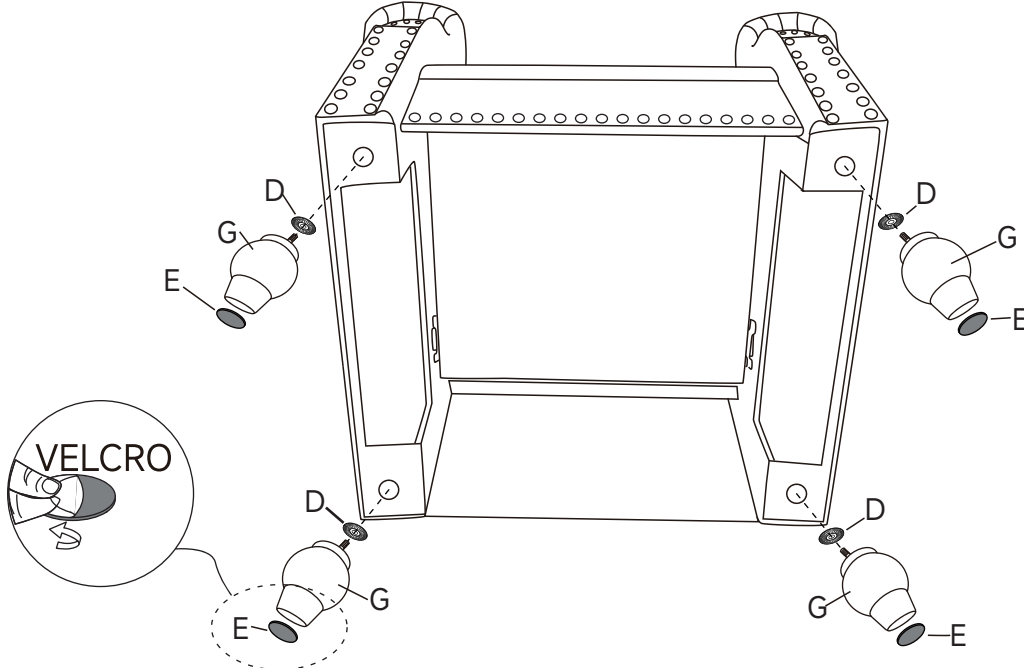

**STEP:** With the sofa lying on its back, first slide an anti-slip washer onto each wooden foot's threaded rod. Then, align the rods with the holes on the armrest base and screw the feet in securely. Finish by applying a felt pad to the bottom of each foot.

# Installation Procedure

Specific operations are shown in the following figure

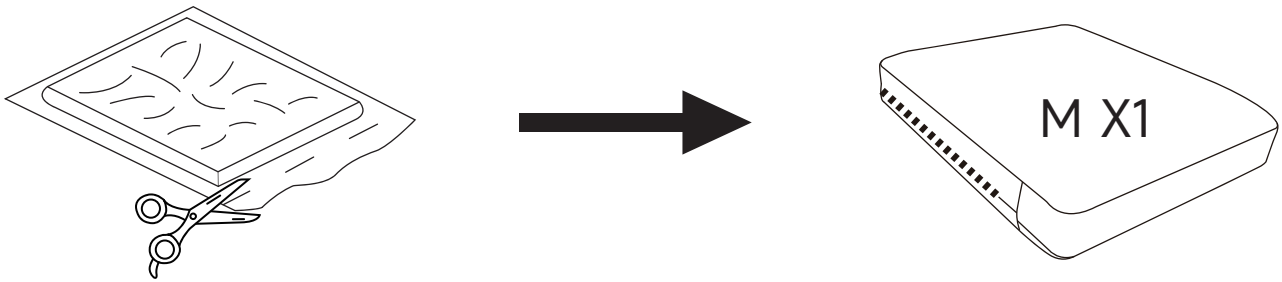

STEP: Carefully cut open the vacuum-sealed packaging and remove the compressed seat cushion(s). Allow them to fully expand before use.

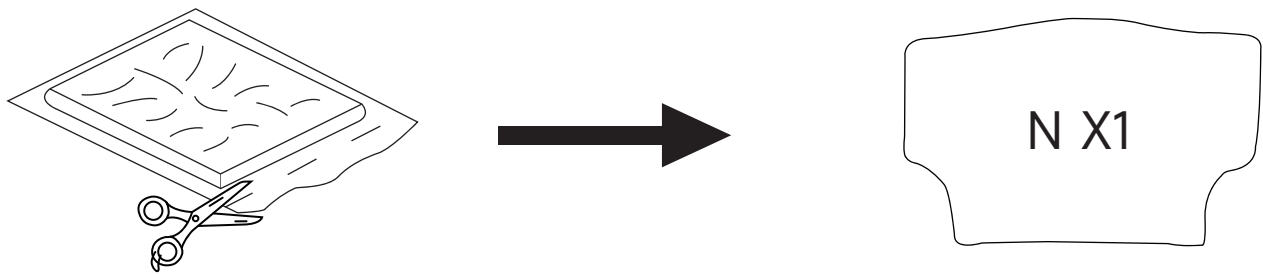

STEP: Carefully cut open the vacuum-sealed bag of the compressed bolster and remove the bolster from it. Allow it to fully expand before installation.

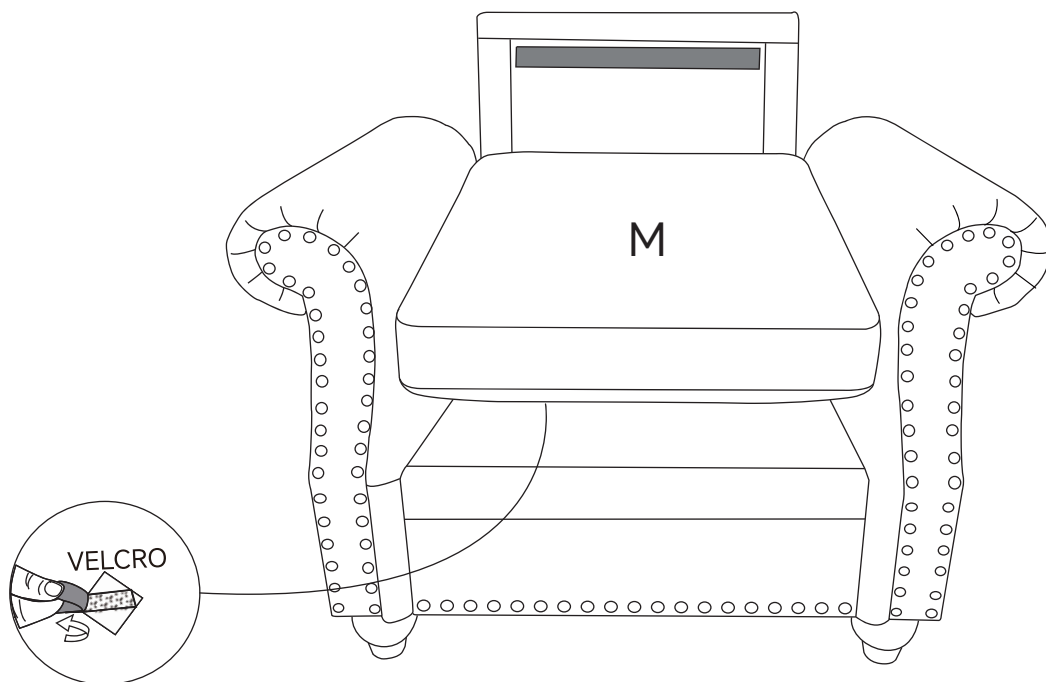

STEP: Remove the backing from the Velcro strips on the seat cushion, then place it on the seat frame with the zipper facing backward, and press down to adhere it securely.

# Installation Procedure

Specific operations are shown in the following figure

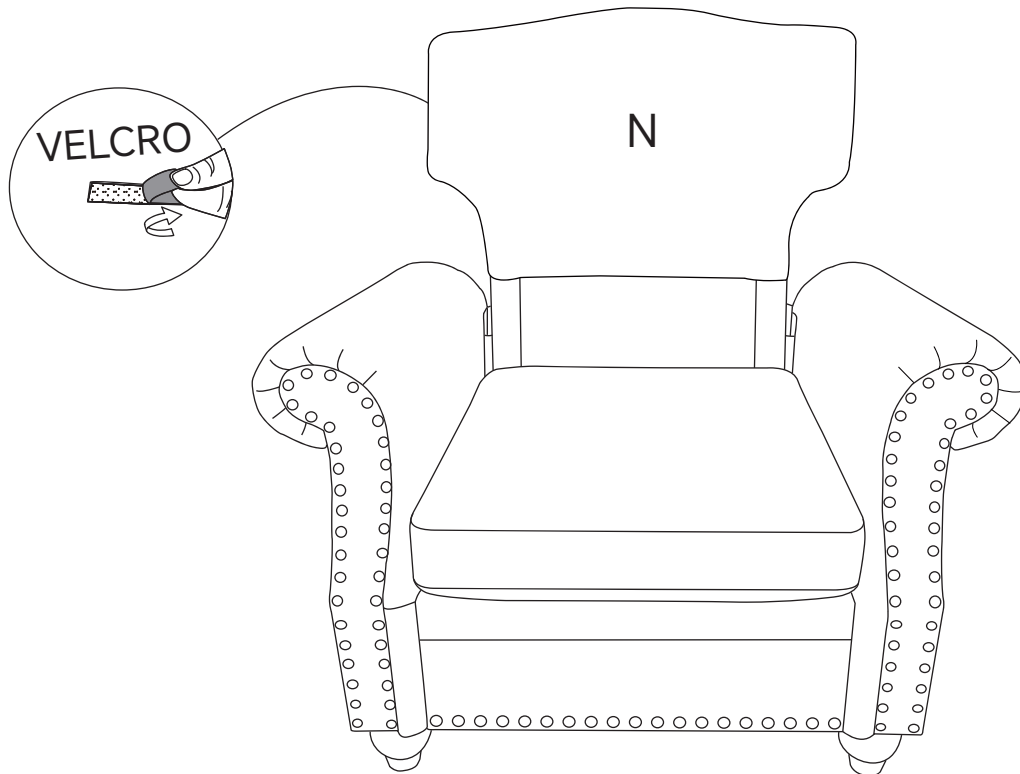

**STEP:** Peel off the backing from the Velcro strips on the backrest. Then, attach the bolster with its zipper facing down, pressing firmly to ensure a secure bond.

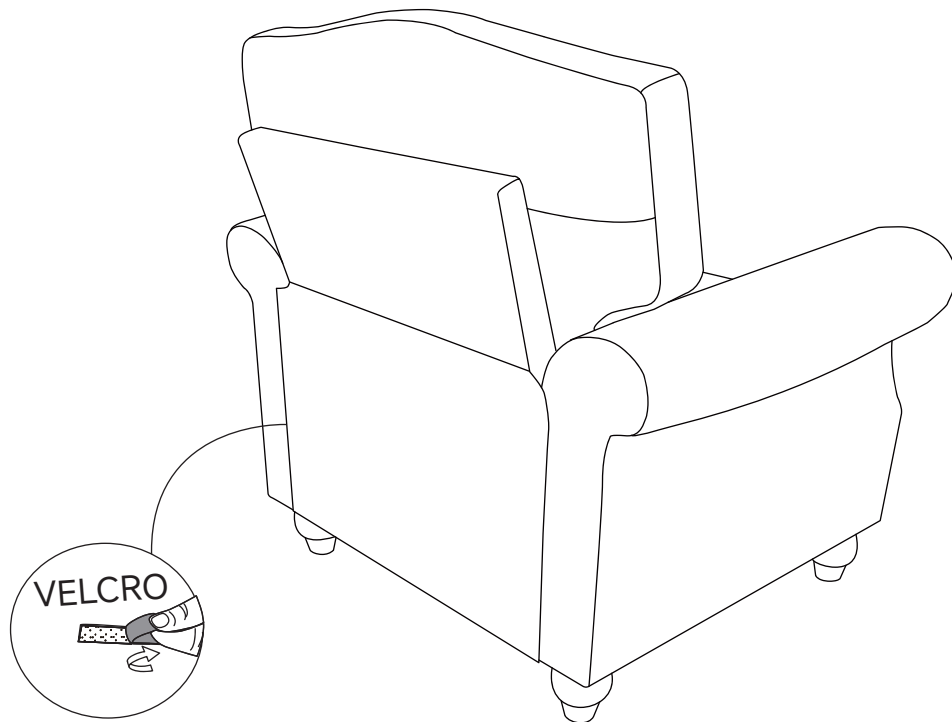

**STEP:** Remove the Velcro strips from the bottom sides of the backrest and apply them to the rear of the armrests.

# Installation Procedure

Specific operations are shown in the following figure

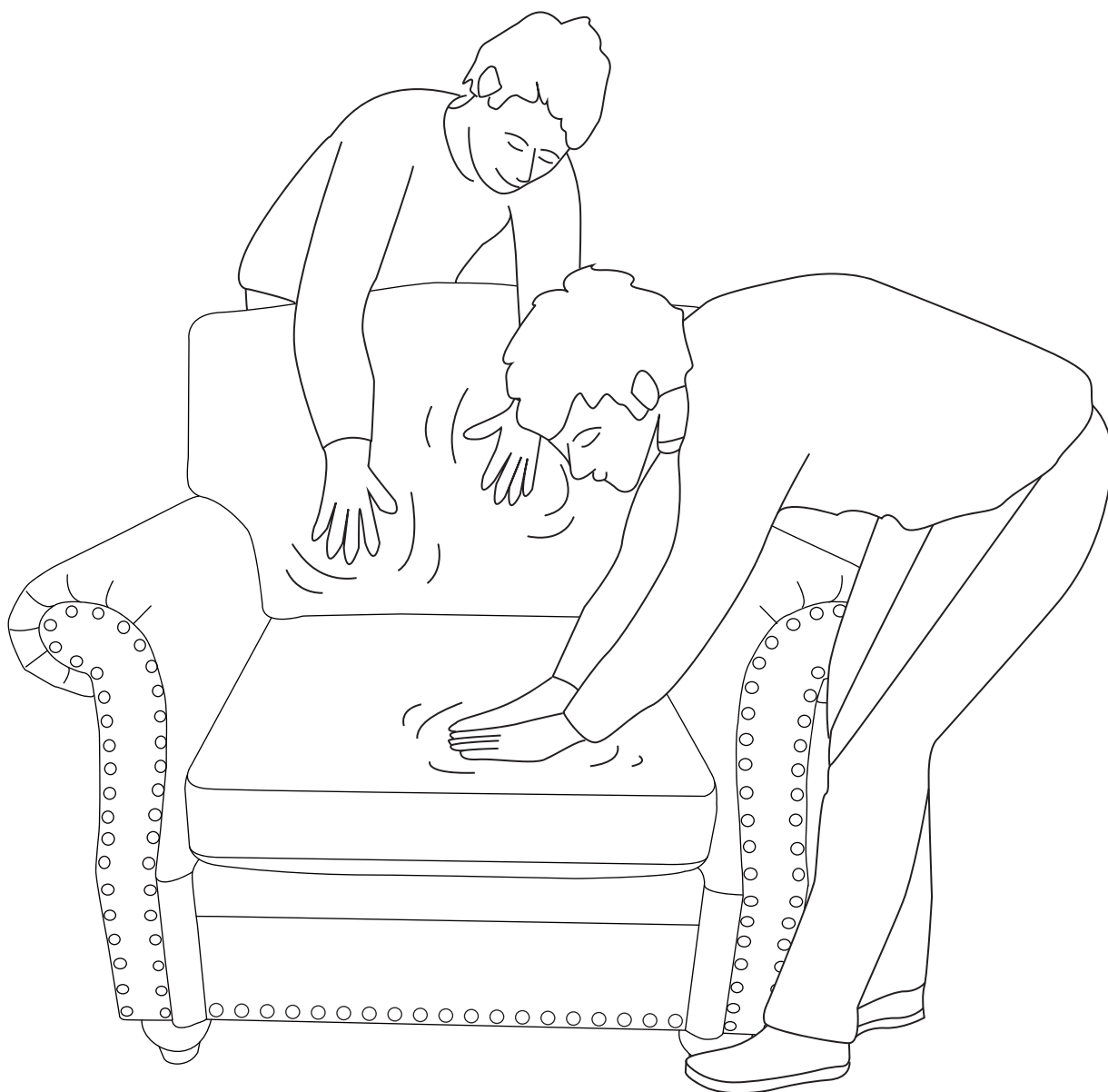

**STEP:** Neatly arrange all the seat cushions and backrest bolsters.