

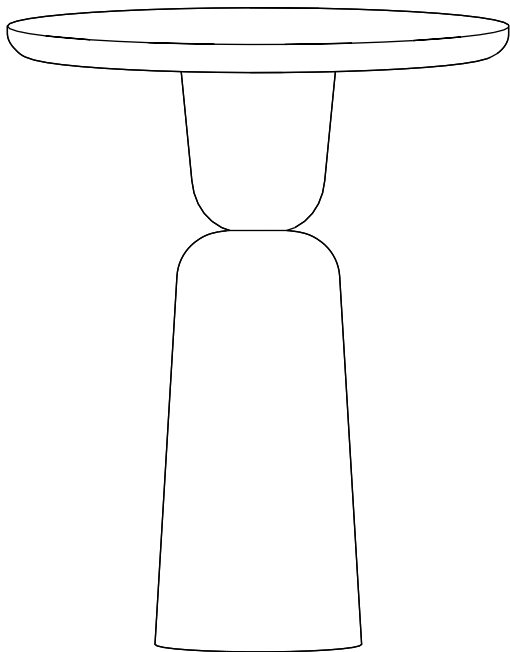

# ASSEMBLY INSTRUCTION FOR

## BRIXTON OUTDOOR BAR TABLE

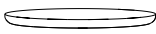
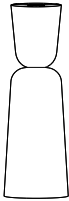

HARDWARE LIST				
A		TOP	Ø863 X 51 mm.	1
B		BASE	Ø356 X 1061 mm.	1
C		LEVELER	Ø20 X 8 35 mm.	3

### Step 1

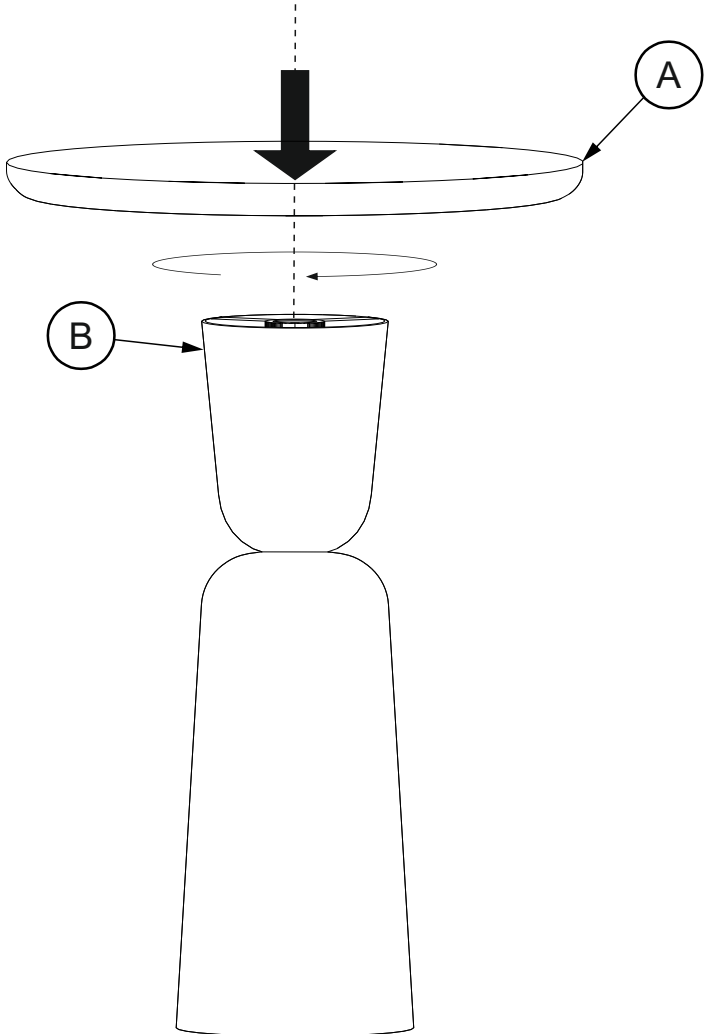

Step 2

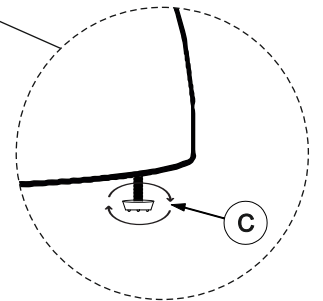
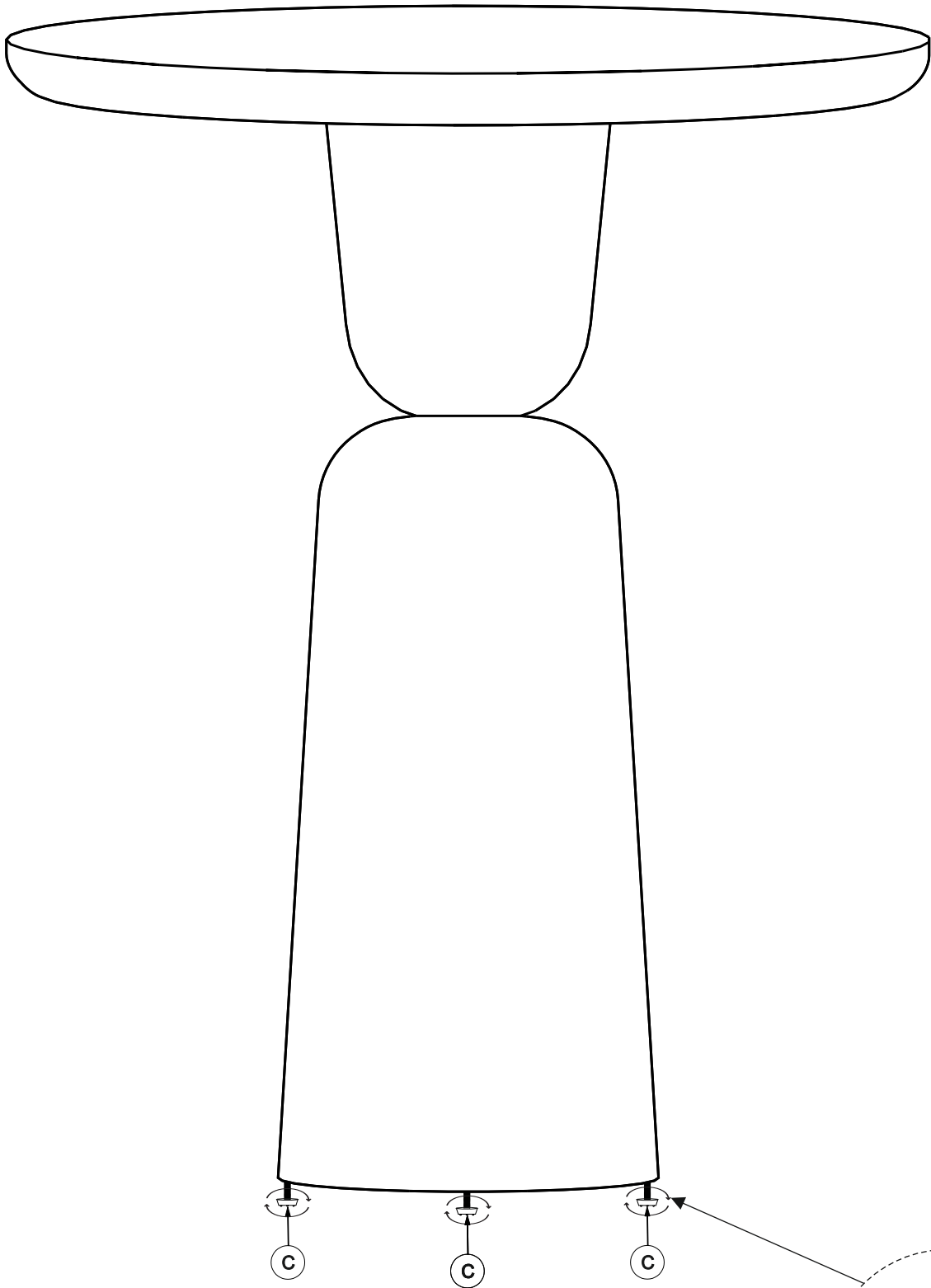

ADJUSTABLE LEVELER FOR  
BALANCE TOP