

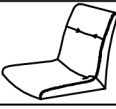







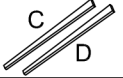

ASSEMBLY INSTRUCTIONS

| PART LIST | | | |
|-----------|--------------------------|---|-------|
| 1 | Chair Body |  | 1 PC |
| 2 | Seat Frame |  | 1 PC |
| 3 | Front Leg |  | 2 PCS |
| 4 | Back Leg |  | 2 PCS |
| 5 | STRETCHER (Long) |  | 1 PC |
| 6 | STRETCHER (Short) |  | 1 PC |
| 7 | STRETCHER (Left & Right) |  | 2 PCS |

| HARDWARE LIST | | | |
|---------------|----------------|---|--------|
| A | JCBC M6 X 60mm |  | 12 PCS |
| B | Spring Washer |  | 12 PCS |
| C | Flat Washer |  | 8 PCS |
| D | CSK SCREW |  | 8 PCS |
| E | Allen Key |  | 1 PC |

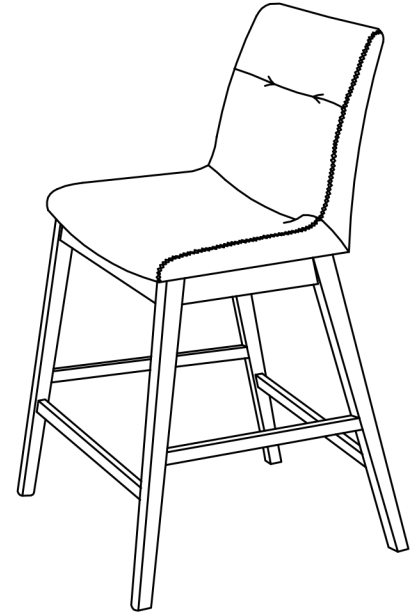

Step 1

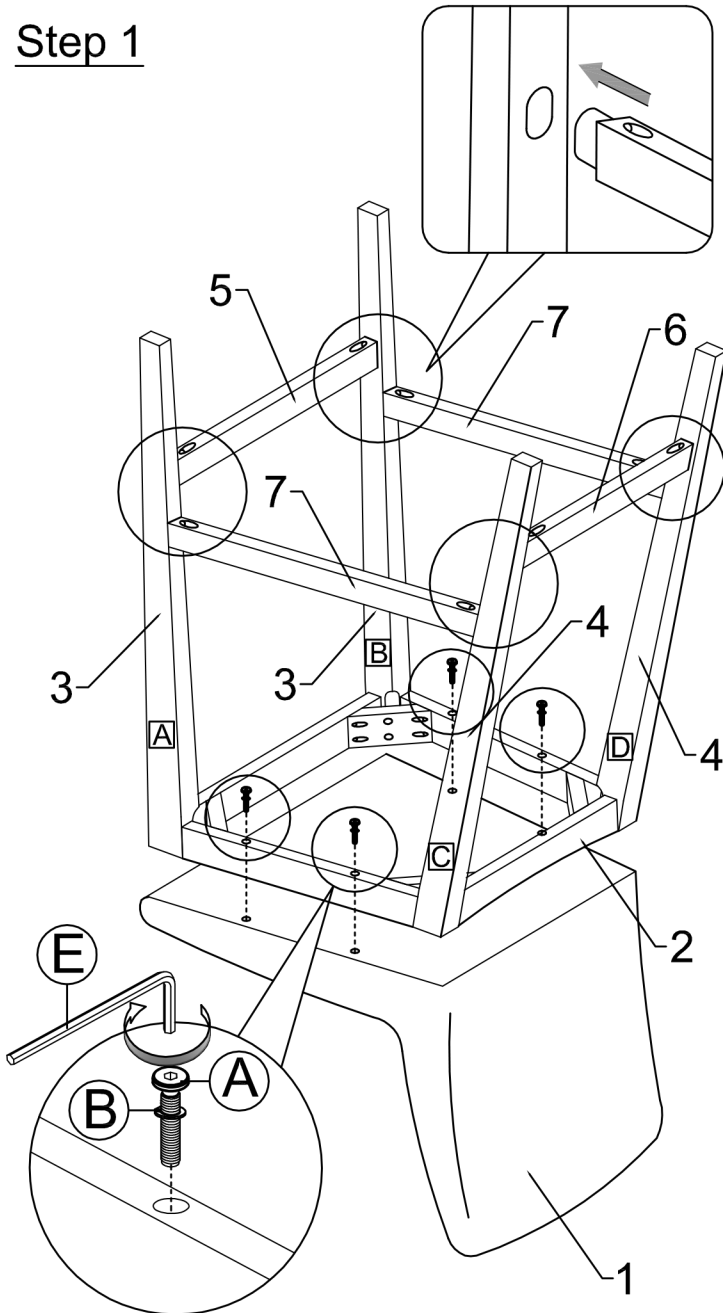

Step 2

