









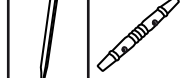

ASSEMBLY INSTRUCTION

DESCRIPTION WINDSOR SIDE CHAIR

Thank you for purchasing this quality product. Be sure to check all packing material carefully for small parts which may have come loose inside the carton during shipment. Identify and count all parts and compare with the parts List Below :

PARTS LIST

SKETCH						
DESCRIPTION	Hoop	Seat Board	Arrow #1	Arrow #2	Arrow #3	Side Stretcher
SKETCH						
DESCRIPTION	Center Stretcher	Front Leg (L)	Front Leg (R)	Back Leg (L)	Back Leg (R)	

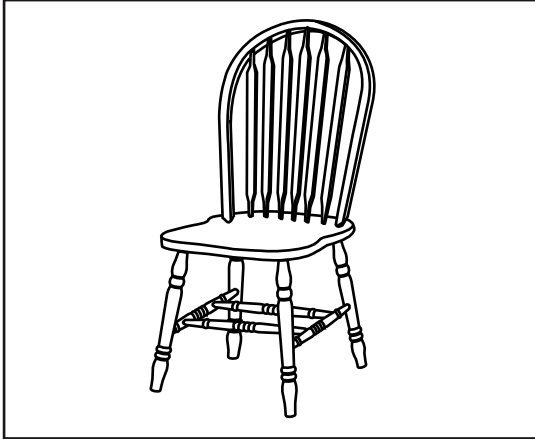

ASSEMBLY STEP

STEP 1

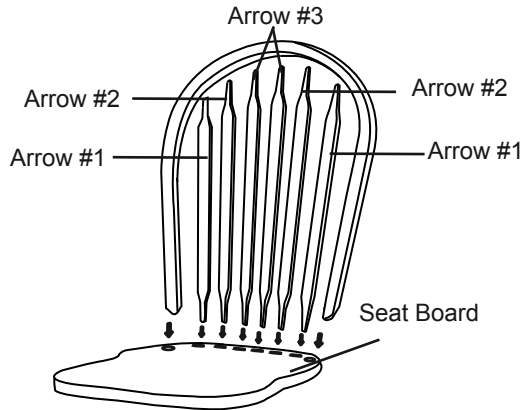

STEP 2

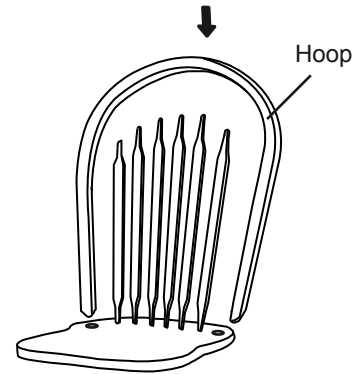

STEP 3

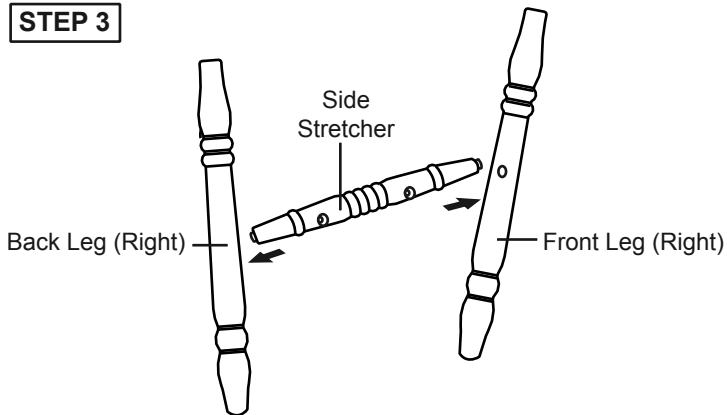

STEP 4

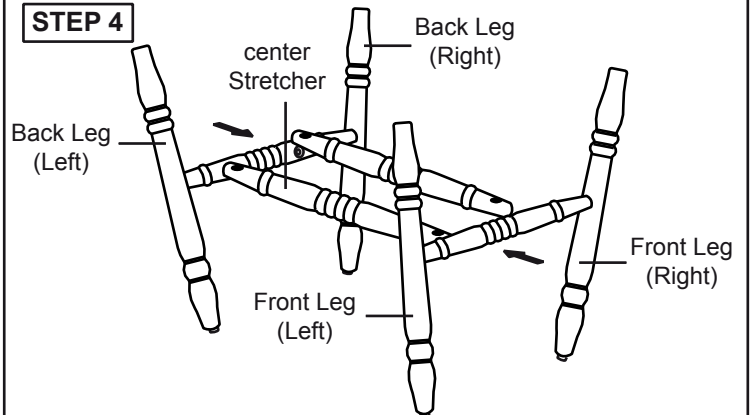

STEP 5

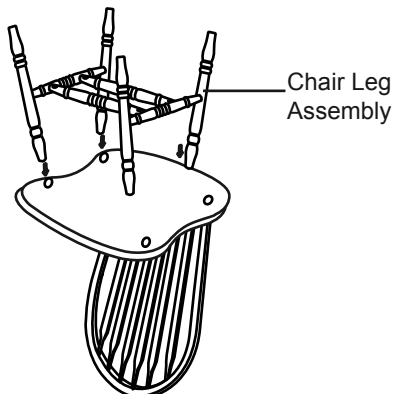

STEP 6

Turn the chair upright. Check its balance.

