

ASSEMBLY INSTRUCTIONS INSTRUCTIONS DE MONTAGE INSTRUCCIONES DE MONTAJE

DRAWER NIGHTSTAND





CAUTION: PLEASE READ ALL INSTRUCTIONS BEFORE STARTING THE ASSEMBLY OF THIS PRODUCT. THESE PIECES ARE HEAVY. IN ORDER TO PREVENT PERSONAL INJURY AND ENSURE THAT THIS PRODUCT IS NOT DAMAGED DURING THE ASSEMBLY PROCESS, IT IS STRONGLY RECOMMENDED TO ENLIST THE ASSISTANCE OF ONE OR MORE PERSONS. IN CASE OF EXCESS STAIN, WIPE THE BOTTOM OF THE UNIT BEFORE PLACING ON ANY SURFACE.

ATTENTION: VEUILLEZ LIRE TOUTES LES INSTRUCTIONS AVANT DE COMMENCER L'ASSEMBLAGE DE CE PRODUIT. LES PIECES SONT LOURDES. POUR EVITER TOUTE BLESSURE ET POUR VOUS ASSURER QUE LE PRODUIT N'EST PAS ENDOMMAGE' PENDANT L'ASSEMBLAGE, NOUS VOUS RECOMMANDONS DE FAIRE APPEL A UNE OU PLUSIEURS AUTRES PERSONNES. EN CAS DE TACHE EXCESSIVE, ESSUYEZ LE FOND DE L'UNITE' AVANT LE PLACEMENT SUR N'IMPORTE QUELLE SURFACE.



CUIDADO: FAVOR DE LEER TODAS LAS INSTRUCCIONES ANTES DE ENSAMBLAR SU PRODUCTO, ESTAS PIEZAS SON PESADAS. PARA PREVENIR HERIDAS PERSONALES Y ASEGURAR QUE SU PRODUCTO NO SEA DAN ADO MIENTRAS ES ENSAMBLADO. SE RECOMIENDA LA ASISTENCIA DE UNA O MAUS PERSONAS.

WARNING: PROTECTIVE GLIDE IS PLACED UNDER EACH LEG OF THE FURNITURE TO RESIST SCRATCHES ON FLOOR SURFACE. SOME FLOOR SURFACES CAN BE EXTRA SENSITIVE TO SCRATCHES AND MARKINGS, IF YOU ARE NOT SURE CONSULT WITH YOUR DEALER. AVERTISSEMENT. LES PIEDS DES MEUBLES SONT MUNIS DE PATINS DESTINES A PROTEGER LE PLANCHER. CERTAINS REVETEMENTS DE SOL PEUVENT ETRE TRES FRAGILES. EN CAS DE DOUTE. CONSULTER LE MARCHAND.

LIST OF PARTS AND HARDWARE/ LISTE DES PIÈCES ET DU MATÉRIEL/ LISTA DE PIEZAS Y HARDWARE

NO#/ NOMBRE/ NÚMERO	DESCRIPTION/ DESCRIPTION/ DESCRIPCIÓN		QUANTITY/ QUANTITÉ/ CANTIDAD
A	Flat washer / Rondelle plate / Arandela plana	Ø5/16"	 8PCS
B	Lock washer / Rondelle de blocage / Arandela de bloqueo	Ø5/16"	 8PCS
C	Bolt / Boulon / Tornillo	Ø5/16"-18x2 3/4"L	 8PCS
D	Wrench / Clé / Llave inglesa	1/2"	 1PC
E	Tilt kit bracket / Support de trousse d'inclinaison / Kit de soporte de inclinación		 1PC

LIST OF PARTS AND HARDWARE/ LISTE DES PIÈCES ET DU MATÉRIEL/ LISTA DE PIEZAS Y HARDWARE

NO#/ NOMBRE/ NÚMERO	DESCRIPTION/ DESCRIPTION/ DESCRIPCIÓN		QUANTITY/ QUANTITÉ/ CANTIDAD
1	DRAWER NIGHTSTAND		1PC
2	Front Foot / Façade Pied / frente Pie		2PCS
3	Back Foot / Dos Pied / Espalda Pie		2PCS

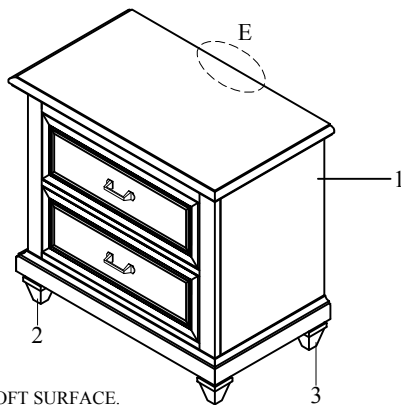

NOTE:
ASSEMBLE UNIT ON A SOFT SURFACE.
ASSEMBLEZ L'UNITÉ SUR UNE SURFACE MOLLE.
ENSAMBLE LA UNIDAD EN UNA SUPERFICIE PLANA Y SUAVE.

DO NOT TIGHTEN BOLTS UNTIL THE UNIT IS COMPLETELY ASSEMBLED.
NE SERREZ PAS LES BOULONS JUSQU'À CE QUE L'UNITÉ SOIT COMPLÈTEMENT ASSEMBLÉE.
NO APRIETE LOS TORNILLOS HASTA QUE LA UNIDAD ESTE COMPLETAMENTE ENSAMBLADA.

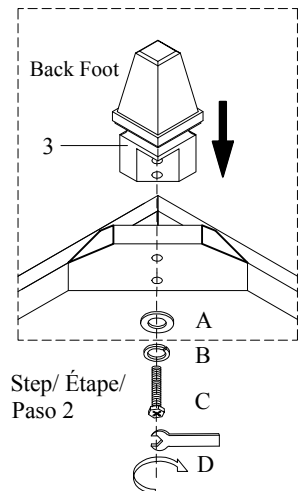
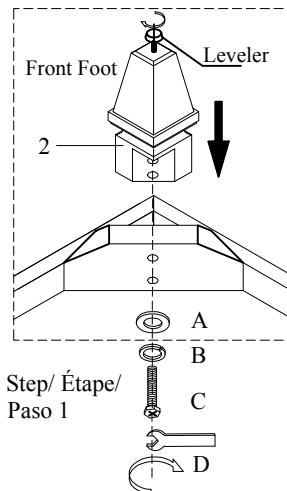

ASSEMBLY INSTRUCTIONS

INSTRUCTIONS DE MONTAGE

INSTRUCCIONES DE MONTAJE

DRAWER CHEST





CAUTION: PLEASE READ ALL INSTRUCTIONS BEFORE STARTING THE ASSEMBLY OF THIS PRODUCT. THESE PIECES ARE HEAVY. IN ORDER TO PREVENT PERSONAL INJURY AND ENSURE THAT THIS PRODUCT IS NOT DAMAGED DURING THE ASSEMBLY PROCESS, IT IS STRONGLY RECOMMENDED TO ENLIST THE ASSISTANCE OF ONE OR MORE PERSONS. IN CASE OF EXCESS STAIN, WIPE THE BOTTOM OF THE UNIT BEFORE PLACING ON ANY SURFACE.

ATTENTION: VEUILLEZ LIRE TOUTES LES INSTRUCTIONS AVANT DE COMMENCER L'ASSEMBLAGE DE CE PRODUIT. LES PIECES SONT LOURDES. POUR EVITER TOUTE BLESSURE ET POUR VOUS ASSURER QUE LE PRODUIT N'EST PAS ENDOMMAGE' PENDANT L'ASSEMBLAGE, NOUS VOUS RECOMMANDONS DE FAIRE APPEL A UNE OU PLUSIEURS AUTRES PERSONNES. EN CAS DE TACHE EXCESSIVE, ESSUYEZ LE FOND DE L'UNITE' AVANT LE PLACEMENT SUR N'IMPORTE QUELLE SURFACE.



CUIDADO: FAVOR DE LEER TODAS LAS INSTRUCCIONES ANTES DE ENSAMBLAR SU PRODUCTO, ESTAS PIEZAS SON PESADAS. PARA PREVENIR HERIDAS PERSONALES Y ASEGURAR QUE SU PRODUCTO NO SEA DAN ADO MIENTRAS ES ENSAMBLADO. SE RECOMIENDA LA ASISTENCIA DE UNA O MAUS PERSONAS.

WARNING: PROTECTIVE GLIDE IS PLACED UNDER EACH LEG OF THE FURNITURE TO RESIST SCRATCHES ON FLOOR SURFACE. SOME FLOOR SURFACES CAN BE EXTRA SENSITIVE TO SCRATCHES AND MARKINGS, IF YOU ARE NOT SURE CONSULT WITH YOUR DEALER. AVERTISSEMENT. LES PIEDS DES MEUBLES SONT MUNIS DE PATINS DESTINES A PROTEGER LE PLANCHER. CERTAINS REVETEMENTS DE SOL PEUVENT ETRE TRES FRAGILES. EN CAS DE DOUTE. CONSULTER LE MARCHAND.

LIST OF PARTS AND HARDWARE/ LISTE DES PIÈCES ET DU MATÉRIEL/ LISTA DE PIEZAS Y HARDWARE

NO#/ NOMBRE/ NÚMERO	DESCRIPTION/ DESCRIPTION/ DESCRIPCIÓN		QUANTITY/ QUANTITÉ/ CANTIDAD
A	Flat washer / Rondelle plate / Arandela plana	Ø5/16"	 8PCS
B	Lock washer / Rondelle de blocage / Arandela de bloqueo	Ø5/16"	 8PCS
C	Bolt / Boulon / Tornillo	Ø5/16"-18x2 3/4"L	 8PCS
D	Wrench / Clé / Llave inglesa	1/2"	 1PC
E	Tilt kit bracket / Support de trousse d'inclinaison / Kit de soporte de inclinación		

LIST OF PARTS AND HARDWARE/ LISTE DES PIÈCES ET DU MATÉRIEL/ LISTA DE PIEZAS Y HARDWARE

NO#/ NOMBRE/ NÚMERO	DESCRIPTION/ DESCRIPTION/ DESCRIPCIÓN		QUANTITY/ QUANTITÉ/ CANTIDAD
1	DRAWER CHEST		1PC
2	Front Foot / Façade Pied / frente Pie		2PCS
3	Back Foot / Dos Pied / Espalda Pie		2PCS

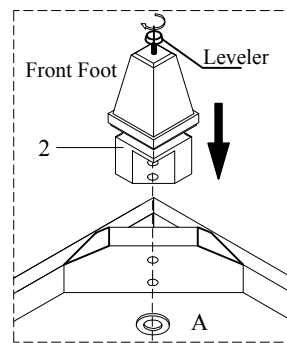

Step/ Étape/
Paso 1

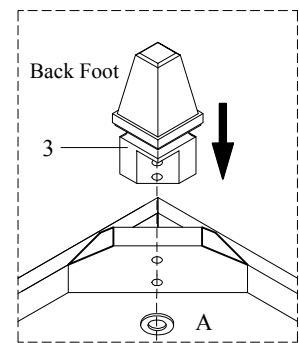

Step/ Étape/
Paso 2

NOTE:
ASSEMBLE UNIT ON A SOFT SURFACE.
ASSEMBLEZ L'UNITÉ SUR UNE SURFACE MOLLE.
ENSAMBLE LA UNIDAD EN UNA SUPERFICIE PLANA Y SUAVE.

DO NOT TIGHTEN BOLTS UNTIL THE UNIT IS COMPLETELY ASSEMBLED.
NE SERREZ PAS LES BOULONS JUSQU'À CE QUE L'UNITÉ SOIT COMPLÈTEMENT ASSEMBLÉE.
NO APRIETE LOS TORNILLOS HASTA QUE LA UNIDAD ESTE COMPLETAMENTE ENSAMBLADA.

ASSEMBLY INSTRUCTIONS INSTRUCTIONS DE MONTAGE INSTRUCCIONES DE MONTAJE

DRAWER DRESSER





CAUTION: PLEASE READ ALL INSTRUCTIONS BEFORE STARTING THE ASSEMBLY OF THIS PRODUCT. THESE PIECES ARE HEAVY. IN ORDER TO PREVENT PERSONAL INJURY AND ENSURE THAT THIS PRODUCT IS NOT DAMAGED DURING THE ASSEMBLY PROCESS, IT IS STRONGLY RECOMMENDED TO ENLIST THE ASSISTANCE OF ONE OR MORE PERSONS. IN CASE OF EXCESS STAIN, WIPE THE BOTTOM OF THE UNIT BEFORE PLACING ON ANY SURFACE.

ATTENTION: VEUILLEZ LIRE TOUTES LES INSTRUCTIONS AVANT DE COMMENCER L'ASSEMBLAGE DE CE PRODUIT. LES PIECES SONT LOURDES. POUR EVITER TOUTE BLESSURE ET POUR VOUS ASSURER QUE LE PRODUIT N'EST PAS ENDOMMAGE' PENDANT L'ASSEMBLAGE, NOUS VOUS RECOMMANDONS DE FAIRE APPEL A UNE OU PLUSIEURS AUTRES PERSONNES. EN CAS DE TACHE EXCESSIVE, ESSUYEZ LE FOND DE L'UNITE' AVANT LE PLACEMENT SUR N'IMPORTE QUELLE SURFACE.





CUIDADO: FAVOR DE LEER TODAS LAS INSTRUCCIONES ANTES DE ENSAMBLAR SU PRODUCTO, ESTAS PIEZAS SON PESADAS. PARA PREVENIR HERIDAS PERSONALES Y ASEGURAR QUE SU PRODUCTO NO SEA DAN ADO MIENTRAS ES ENSAMBLADO. SE RECOMIENDA LA ASISTENCIA DE UNA O MAUS PERSONAS.

WARNING: PROTECTIVE GLIDE IS PLACED UNDER EACH LEG OF THE FURNITURE TO RESIST SCRATCHES ON FLOOR SURFACE. SOME FLOOR SURFACES CAN BE EXTRA SENSITIVE TO SCRATCHES AND MARKINGS, IF YOU ARE NOT SURE CONSULT WITH YOUR DEALER. AVERTISSEMENT. LES PIEDS DES MEUBLES SONT MUNIS DE PATINS DESTINES A PROTEGER LE PLANCHER. CERTAINS REVETEMENTS DE SOL PEUVENT ETRE TRES FRAGILES. EN CAS DE DOUTE. CONSULTER LE MARCHAND.

LIST OF PARTS AND HARDWARE/ LISTE DES PIÈCES ET DU MATÉRIEL/ LISTA DE PIEZAS Y HARDWARE

NO#/ NOMBRE/ NÚMERO	DESCRIPTION/ DESCRIPTION/ DESCRIPCIÓN		QUANTITY/ QUANTITÉ/ CANTIDAD
A	Flat washer / Rondelle plate / Arandela plana	Ø5/16"	 8PCS
B	Lock washer / Rondelle de blocage / Arandela de bloqueo	Ø5/16"	 8PCS
C	Bolt / Boulon / Tornillo	Ø5/16"-18x2 3/4"L	 8PCS
D	Wrench / Clé / Llave inglesa	1/2"	 1PC
E	Tilt kit bracket / Support de trousse d'inclinaison / Kit de soporte de inclinación		 1PC

LIST OF PARTS AND HARDWARE/ LISTE DES PIÈCES ET DU MATÉRIEL/ LISTA DE PIEZAS Y HARDWARE

NO#/ NOMBRE/ NÚMERO	DESCRIPTION/ DESCRIPTION/ DESCRIPCIÓN		QUANTITY/ QUANTITÉ/ CANTIDAD
1	DRAWER DRESSER		1PC
2	Front Foot / Façade Pied / frente Pie		2PCS
3	Back Foot / Dos Pied / Espalda Pie		2PCS
4	SUPPORT LEG/ JAMBE D'APPUI PIERNA DE APOYO	 121x38x38mm	2PCS

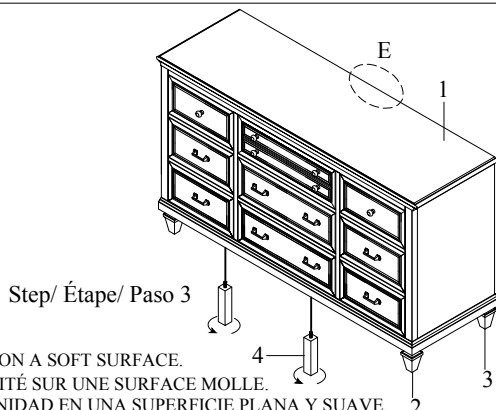

NOTE:
ASSEMBLE UNIT ON A SOFT SURFACE.
ASSEMBLEZ L'UNITÉ SUR UNE SURFACE MOLLE.
ENSAMBLE LA UNIDAD EN UNA SUPERFICIE PLANA Y SUAVE.

DO NOT TIGHTEN BOLTS UNTIL THE UNIT IS COMPLETELY ASSEMBLED.
NE SERREZ PAS LES BOULONS JUSQU'À CE QUE L'UNITÉ SOIT COMPLÈTEMENT ASSEMBLÉE.
NO APRIETE LOS TORNILLOS HASTA QUE LA UNIDAD ESTE COMPLETAMENTE ENSAMBLADA.

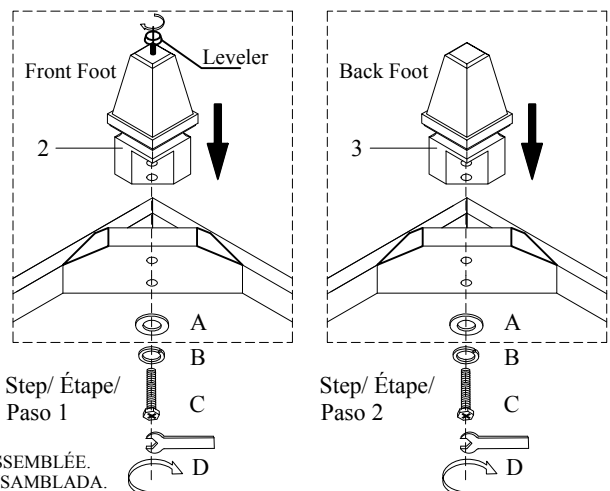

ASSEMBLY INSTRUCTIONS

INSTRUCTIONS DE MONTAGE

INSTRUCCIONES DE MONTAJE

GENTLEMAN'S CHEST





CAUTION: PLEASE READ ALL INSTRUCTIONS BEFORE STARTING THE ASSEMBLY OF THIS PRODUCT. THESE PIECES ARE HEAVY. IN ORDER TO PREVENT PERSONAL INJURY AND ENSURE THAT THIS PRODUCT IS NOT DAMAGED DURING THE ASSEMBLY PROCESS, IT IS STRONGLY RECOMMENDED TO ENLIST THE ASSISTANCE OF ONE OR MORE PERSONS. IN CASE OF EXCESS STAIN, WIPE THE BOTTOM OF THE UNIT BEFORE PLACING ON ANY SURFACE.

ATTENTION: VEUILLEZ LIRE TOUTES LES INSTRUCTIONS AVANT DE COMMENCER L'ASSEMBLAGE DE CE PRODUIT. LES PIECES SONT LOURDES. POUR EVITER TOUTE BLESSURE ET POUR VOUS ASSURER QUE LE PRODUIT N'EST PAS ENDOMMAGE' PENDANT L'ASSEMBLAGE, NOUS VOUS RECOMMANDONS DE FAIRE APPEL A UNE OU PLUSIEURS AUTRES PERSONNES. EN CAS DE TACHE EXCESSIVE, ESSUYEZ LE FOND DE L'UNITE' AVANT LE PLACEMENT SUR N'IMPORTE QUELLE SURFACE.





CUIDADO: FAVOR DE LEER TODAS LAS INSTRUCCIONES ANTES DE ENSAMBLAR SU PRODUCTO, ESTAS PIEZAS SON PESADAS. PARA PREVENIR HERIDAS PERSONALES Y ASEGURAR QUE SU PRODUCTO NO SEA DAN ADO MIENTRAS ES ENSAMBLADO. SE RECOMIENDA LA ASISTENCIA DE UNA O MAUS PERSONAS.

WARNING: PROTECTIVE GLIDE IS PLACED UNDER EACH LEG OF THE FURNITURE TO RESIST SCRATCHES ON FLOOR SURFACE. SOME FLOOR SURFACES CAN BE EXTRA SENSITIVE TO SCRATCHES AND MARKINGS, IF YOU ARE NOT SURE CONSULT WITH YOUR DEALER. AVERTISSEMENT. LES PIEDS DES MEUBLES SONT MUNIS DE PATINS DESTINES A PROTEGER LE PLANCHER. CERTAINS REVETEMENTS DE SOL PEUVENT ETRE TRES FRAGILES. EN CAS DE DOUTE. CONSULTER LE MARCHAND.

LIST OF PARTS AND HARDWARE/ LISTE DES PIÈCES ET DU MATÉRIEL/ LISTA DE PIEZAS Y HARDWARE

NO#/ NOMBRE/ NÚMERO	DESCRIPTION/ DESCRIPTION/ DESCRIPCIÓN		QUANTITY/ QUANTITÉ/ CANTIDAD
A	Flat washer / Rondelle plate / Arandela plana	Ø5/16"	 8PCS
B	Lock washer / Rondelle de blocage / Arandela de bloqueo	Ø5/16"x	 8PCS
C	Bolt / Boulon / Tornillo	Ø5/16"-18x2 3/4"L	 8PCS
D	Wrench / Clé / Llave inglesa	1/2"	 1PC
E	Tilt kit bracket / Support de trousse d'inclinaison / Kit de soporte de inclinación		1PC
F	Felt pad	Ø5/8"x1/8"	 4PCS

LIST OF PARTS AND HARDWARE/ LISTE DES PIÈCES ET DU MATÉRIEL/ LISTA DE PIEZAS Y HARDWARE

NO#/ NOMBRE/ NÚMERO	DESCRIPTION/ DESCRIPTION/ DESCRIPCIÓN		QUANTITY/ QUANTITÉ/ CANTIDAD
1	GENTLEMAN'S CHEST		1PC
2	Front Foot / Façade Pied / frente Pie		2PCS
3	Back Foot / Dos Pied / Espalda Pie		2PCS
4	Sliding door / Porte coulissante / puerta corredera		1PC
5	Support Leg / Jambe d'appui / pierna de apoyo	 138x38x38mm	1PC

NOTE:
ASSEMBLE UNIT ON A SOFT SURFACE.
ASSEMBLEZ L'UNITÉ SUR UNE SURFACE MOLLE.
ENSAMBLE LA UNIDAD EN UNA SUPERFICIE PLANA Y SUAVE.

DO NOT TIGHTEN BOLTS UNTIL THE UNIT IS COMPLETELY ASSEMBLED.
NE SERREZ PAS LES BOULONS JUSQU'À CE QUE L'UNITÉ SOIT COMPLÈTEMENT ASSEMBLÉE.
NO APRIETE LOS TORNILLOS HASTA QUE LA UNIDAD ESTE COMPLETAMENTE ENSAMBLADA.

ASSEMBLY INSTRUCTIONS INSTRUCTIONS DE MONTAGE INSTRUCCIONES DE MONTAJE

GENTLEMAN'S CHEST

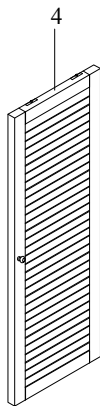
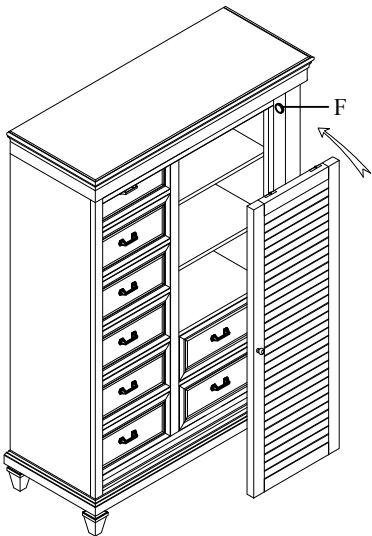
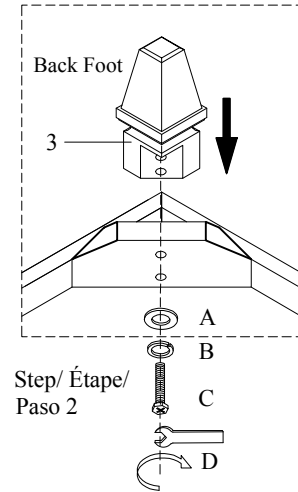
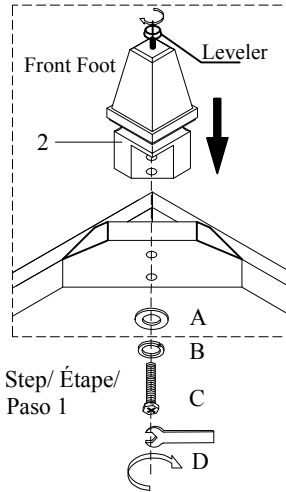
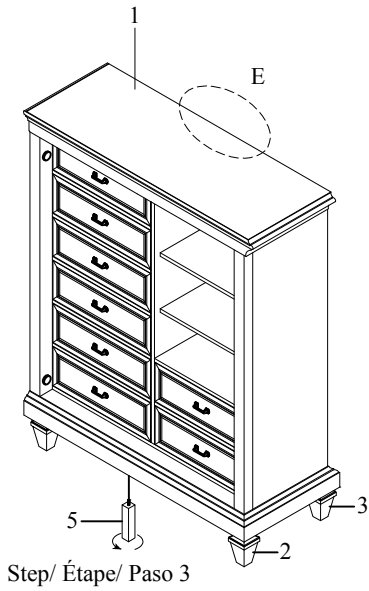

Step/ Étape/ Paso 4

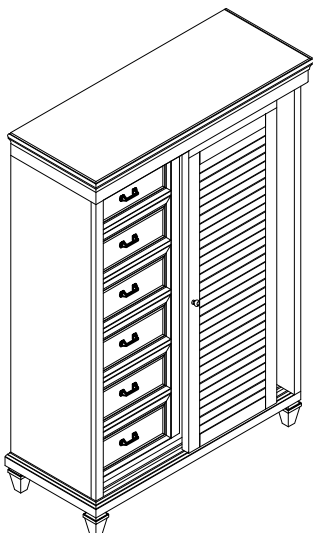
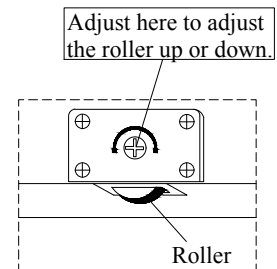
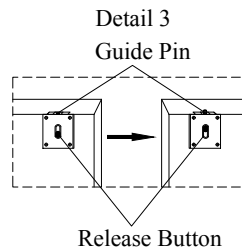

Install the door (if necessary):

Push the guide pins down so they are inside the door. Place the roller on the metal track so the door rolls smoothly. Place the top of the door underneath the track so when you push the release button (Detail 3) the pins go up in to the track.

Remove the door (if necessary):

Push the guide pins down so they are inside the door, and take the door off.

ASSEMBLY INSTRUCTIONS INSTRUCTIONS DE MONTAGE INSTRUCCIONES DE MONTAJE

WARDROBE





CAUTION: PLEASE READ ALL INSTRUCTIONS BEFORE STARTING THE ASSEMBLY OF THIS PRODUCT. THESE PIECES ARE HEAVY. IN ORDER TO PREVENT PERSONAL INJURY AND ENSURE THAT THIS PRODUCT IS NOT DAMAGED DURING THE ASSEMBLY PROCESS, IT IS STRONGLY RECOMMENDED TO ENLIST THE ASSISTANCE OF ONE OR MORE PERSONS. IN CASE OF EXCESS STAIN, WIPE THE BOTTOM OF THE UNIT BEFORE PLACING ON ANY SURFACE.

ATTENTION: VEUILLEZ LIRE TOUTES LES INSTRUCTIONS AVANT DE COMMENCER L'ASSEMBLAGE DE CE PRODUIT. LES PIECES SONT LOURDES. POUR EVITER TOUTE BLESSURE ET POUR VOUS ASSURER QUE LE PRODUIT N'EST PAS ENDOMMAGE' PENDANT L'ASSEMBLAGE, NOUS VOUS RECOMMANDONS DE FAIRE APPEL A UNE OU PLUSIEURS AUTRES PERSONNES. EN CAS DE TACHE EXCESSIVE, ESSUYEZ LE FOND DE L'UNITE' AVANT LE PLACEMENT SUR N'IMPORTE QUELLE SURFACE.



CUIDADO: FAVOR DE LEER TODAS LAS INSTRUCCIONES ANTES DE ENSAMBLAR SU PRODUCTO, ESTAS PIEZAS SON PESADAS. PARA PREVENIR HERIDAS PERSONALES Y ASEGURAR QUE SU PRODUCTO NO SEA DAN ADO MIENTRAS ES ENSAMBLADO. SE RECOMIENDA LA ASISTENCIA DE UNA O MAUS PERSONAS.

WARNING: PROTECTIVE GLIDE IS PLACED UNDER EACH LEG OF THE FURNITURE TO RESIST SCRATCHES ON FLOOR SURFACE. SOME FLOOR SURFACES CAN BE EXTRA SENSITIVE TO SCRATCHES AND MARKINGS, IF YOU ARE NOT SURE CONSULT WITH YOUR DEALER. AVERTISSEMENT. LES PIEDS DES MEUBLES SONT MUNIS DE PATINS DESTINES A PROTEGER LE PLANCHER. CERTAINS REVETEMENTS DE SOL PEUVENT ETRE TRES FRAGILES. EN CAS DE DOUTE. CONSULTER LE MARCHAND.

LIST OF PARTS AND HARDWARE/ LISTE DES PIÈCES ET DU MATÉRIEL/ LISTA DE PIEZAS Y HARDWARE

NO#/ NOMBRE/ NÚMERO	DESCRIPTION/ DESCRIPTION/ DESCRIPCIÓN		QUANTITY/ QUANTITÉ/ CANTIDAD
A	Flat washer / Rondelle plate / Arandela plana	Ø5/16"	 8PCS
B	Lock washer / Rondelle de blocage / Arandela de bloqueo	Ø5/16"	 8PCS
C	Bolt / Boulon / Tornillo	Ø5/16"-18x2 3/4"L	 8PCS
D	Wrench / Clé / Llave inglesa	1/2"	 1PC
E	Tilt kit bracket / Support de trousse d'inclinaison / Kit de soporte de inclinación		 1PC

LIST OF PARTS AND HARDWARE/ LISTE DES PIÈCES ET DU MATÉRIEL/ LISTA DE PIEZAS Y HARDWARE

NO#/ NOMBRE/ NÚMERO	DESCRIPTION/ DESCRIPTION/ DESCRIPCIÓN		QUANTITY/ QUANTITÉ/ CANTIDAD
1	WARDROBE		1PC
2	Front Foot / Façade Pied / frente Pie		2PCS
3	Back Foot / Dos Pied / Espalda Pie		2PCS

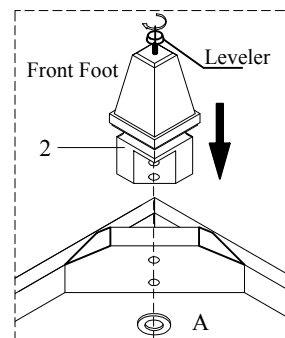
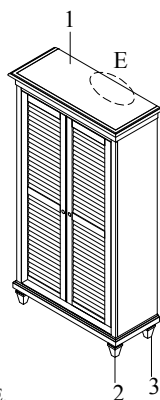

Step/ Étape/
Paso 1

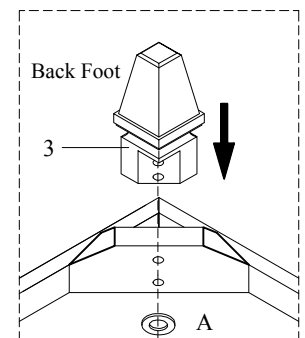

Step/ Étape/
Paso 2

NOTE:
ASSEMBLE UNIT ON A SOFT SURFACE.
ASSEMBLEZ L'UNITÉ SUR UNE SURFACE MOLLE.
ENSAMBLE LA UNIDAD EN UNA SUPERFICIE PLANA Y SUAVE.

DO NOT TIGHTEN BOLTS UNTIL THE UNIT IS COMPLETELY ASSEMBLED.
NE SERREZ PAS LES BOULONS JUSQU'À CE QUE L'UNITÉ SOIT COMPLÈTEMENT ASSEMBLÉE.
NO APRIETE LOS TORNILLOS HASTA QUE LA UNIDAD ESTE COMPLETAMENTE ENSAMBLADA.

ASSEMBLY INSTRUCTIONS INSTRUCTIONS DE MONTAGE INSTRUCCIONES DE MONTAJE

MEDIA CHEST





CAUTION: PLEASE READ ALL INSTRUCTIONS BEFORE STARTING THE ASSEMBLY OF THIS PRODUCT. THESE PIECES ARE HEAVY. IN ORDER TO PREVENT PERSONAL INJURY AND ENSURE THAT THIS PRODUCT IS NOT DAMAGED DURING THE ASSEMBLY PROCESS, IT IS STRONGLY RECOMMENDED TO ENLIST THE ASSISTANCE OF ONE OR MORE PERSONS. IN CASE OF EXCESS STAIN, WIPE THE BOTTOM OF THE UNIT BEFORE PLACING ON ANY SURFACE.

ATTENTION: VEUILLEZ LIRE TOUTES LES INSTRUCTIONS AVANT DE COMMENCER L'ASSEMBLAGE DE CE PRODUIT. LES PIECES SONT LOURDES. POUR EVITER TOUTE BLESSURE ET POUR VOUS ASSURER QUE LE PRODUIT N'EST PAS ENDOMMAGE PENDANT L'ASSEMBLAGE, NOUS VOUS RECOMMANDONS DE FAIRE APPEL A UNE OU PLUSIEURS AUTRES PERSONNES. EN CAS DE TACHE EXCESSIVE, ESSUYEZ LE FOND DE L'UNITE AVANT LE PLACEMENT SUR N'IMPORTE QUELLE SURFACE.



CUIDADO: FAVOR DE LEER TODAS LAS INSTRUCCIONES ANTES DE ENSAMBLAR SU PRODUCTO, ESTAS PIEZAS SON PESADAS. PARA PREVENIR HERIDAS PERSONALES Y ASEGURAR QUE SU PRODUCTO NO SEA DANADO MIENTRAS ES ENSAMBLADO. SE RECOMIENDA LA ASISTENCIA DE UNA O MAS PERSONAS.

WARNING: PROTECTIVE GLIDE IS PLACED UNDER EACH LEG OF THE FURNITURE TO RESIST SCRATCHES ON FLOOR SURFACE. SOME FLOOR SURFACES CAN BE EXTRA SENSITIVE TO SCRATCHES AND MARKINGS, IF YOU ARE NOT SURE CONSULT WITH YOUR DEALER. AVERTISSEMENT. LES PIEDS DES MEUBLES SONT MUNIS DE PATINS DESTINES A PROTEGER LE PLANCHER. CERTAINS REVETEMENTS DE SOL PEUVENT ETRE TRES FRAGILES. EN CAS DE DOUTE CONSULTER LE MARCHAND.

LIST OF PARTS AND HARDWARE/ LISTE DES PIÈCES ET DU MATÉRIEL/ LISTA DE PIEZAS Y HARDWARE

NO#/ NOMBRE/ NÚMERO	DESCRIPTION/ DESCRIPTION/ DESCRIPCIÓN		QUANTITY/ QUANTITÉ/ CANTIDAD
A	Flat washer/ Rondelle plate/ Arandela plana	Ø5/16"	 8PCS
B	Lock washer/ Rondelle de blocage/ Arandela de bloqueo	Ø5/16"	 8PCS
C	Bolt/ Boulon/ Tornillo	Ø5/16"-18x2 3/4"L	 8PCS
D	Wrench/ Clé/ Llave inglesa	1/2"	 1PC
E	Tilt kit bracket/ Support de trousse d'inclinaison/ Kit de soporte de inclinación		 1PC

LIST OF PARTS AND HARDWARE/ LISTE DES PIÈCES ET DU MATÉRIEL/ LISTA DE PIEZAS Y HARDWARE

NO#/ NOMBRE/ NÚMERO	DESCRIPTION/ DESCRIPTION/ DESCRIPCIÓN		QUANTITY/ QUANTITÉ/ CANTIDAD
1	MEDIA CHEST		1PC
2	Front Foot / Façade Pied / frente Pie		2PCS
3	Back Foot / Dos Pied / Espalda Pie		2PCS

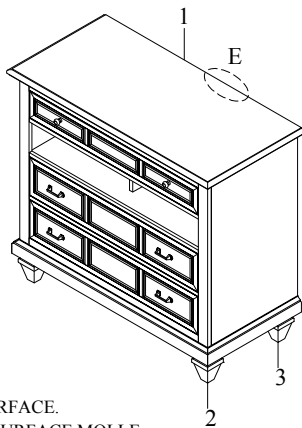

NOTE:
ASSEMBLE UNIT ON A SOFT SURFACE.
ASSEMBLEZ L'UNITÉ SUR UNE SURFACE MOLLE.
ENSAMBLE LA UNIDAD EN UNA SUPERFICIE PLANA Y SUAVE.

DO NOT TIGHTEN BOLTS UNTIL THE UNIT IS COMPLETELY ASSEMBLED.
NE SERREZ PAS LES BOULONS JUSQU'À CE QUE L'UNITÉ SOIT COMPLÈTEMENT ASSEMBLÉE.
NO APRIETE LOS TORNILLOS HASTA QUE LA UNIDAD ESTE COMPLETAMENTE ENSAMBLADA.

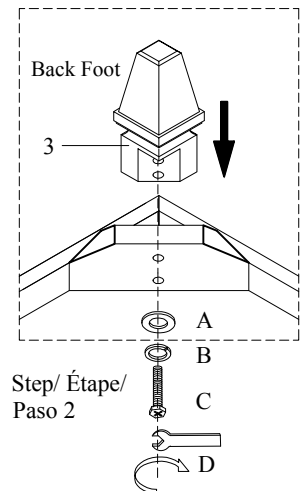
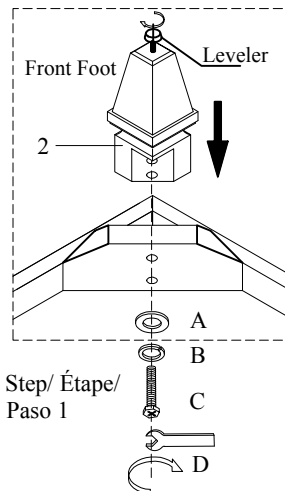

ASSEMBLY INSTRUCTIONS INSTRUCTIONS DE MONTAGE INSTRUCCIONES DE MONTAJE









KING SHUTTER PANEL BED HB
KING SHUTTER PANEL BED FB
QUEEN/KING SHUTTER PANEL BED RS

CAUTION: PLEASE READ ALL INSTRUCTIONS BEFORE STARTING THE ASSEMBLY OF THIS PRODUCT. THESE PIECES ARE HEAVY. IN ORDER TO PREVENT PERSONAL INJURY AND ENSURE THAT THIS PRODUCT IS NOT DAMAGED DURING THE ASSEMBLY PROCESS, IT IS STRONGLY RECOMMENDED TO ENLIST THE ASSISTANCE OF ONE OR MORE PERSONS. IN CASE OF EXCESS STAIN, WIPE THE BOTTOM OF THE UNIT BEFORE PLACING ON ANY SURFACE.

ATTENTION: VEUILLEZ LIRE TOUTES LES INSTRUCTIONS AVANT DE COMMENCER L'ASSEMBLAGE DE CE PRODUIT. LES PIECES SONT LOURDES. POUR EVITER TOUTE BLESSURE ET POUR VOUS ASSURER QUE LE PRODUIT N'EST PAS ENDOMMAGE' PENDANT L'ASSEMBLAGE, NOUS VOUS RECOMMANDONS DE FAIRE APPEL A UNE OU PLUSIEURS AUTRES PERSONNES. EN CAS DE TACHE EXCESSIVE, ESSUYEZ LE FOND DE L'UNITE' AVANT LE PLACEMENT SUR N'IMPORTE QUELLE SURFACE.

CUIDADO: FAVOR DE LEER TODAS LAS INSTRUCCIONES ANTES DE ENSAMBLAR SU PRODUCTO, ESTAS. PIEZAS SON PESADAS. PARA PREVENIR HERIDAS PERSONALES Y ASEGURAR QUE SU PRODUCTO NO SEA DAN ADO MIENTRAS ES ENSAMBLADO. SE RECOMIENDA LA ASISTENCIA DE UNA O MAUS PERSONAS.

WARNING: PROTECTIVE GLIDE IS PLACED UNDER EACH LEG OF THE FURNITURE TO RESIST SCRATCHES ON FLOOR SURFACE. SOME FLOOR SURFACES CAN BE EXTRA SENSITIVE TO SCRATCHES AND MARKINGS, IF YOU ARE NOT SURE CONSULT WITH YOUR DEALER. AVERTISSEMENT. LES PIEDS DES MEUBLES SONT MUNIS DE PATINS DESTINES A PROTEGER LE PLANCHER. CERTAINS REVETEMENTS DE SOL PEUVENT ETRE TRES FRAGILES. EN CAS DE DOUTE. CONSULTER LE MARCHAND.

LIST OF PARTS AND HARDWARE/ LISTE DES PIÈCES ET DU MATÉRIEL/ LISTA DE PIEZAS Y HARDWARE				
NO#/ NOMBRE/ NÚMERO	DESCRIPTION/ DESCRIPTION/ DESCRIPCIÓN			QUANTITY/ QUANTITÉ/ CANTIDAD
A	Bolt / Boulon / Tornillo	Ø5/16"-18x4 1/2"L		8PCS
B	Lock washer "C" / Rondelle de blocage "C" / Arandela de bloqueo "C"	Ø5/16"		8PCS
C	Nut / Écrou / Nuez	Ø5/16"		8PCS
D	Flat washer / Rondelle plate / Arandela plana	Ø5/16"		14PCS
E	Lock washer / Rondelle de blocage / Arandela de bloqueo	Ø5/16"		14PCS
F	Bolt / Boulon / Tornillo	Ø5/16"-18x2"L		10PCS
G	Bolt / Boulon / Tornillo	Ø5/16"-18x3 1/4"L		4PCS
H	Wrench / Clé / Llave inglesa	1/2"		1PCS
I	Screw / Vis / tornillo de punta	M4-8x1"		8PCS

LIST OF PARTS AND HARDWARE/ LISTE DES PIÈCES ET DU MATÉRIEL/ LISTA DE PIEZAS Y HARDWARE			
NO#/ NOMBRE/ NÚMERO	DESCRIPTION/ DESCRIPTION/ DESCRIPCIÓN		QUANTITY/ QUANTITÉ/ CANTIDAD
1	KING SHUTTER PANEL BED HEADBOARD		1PC
2L	Left Leg / Patte gauche / Pierna izquierda		1PC
2R	Right Leg / Patte droite / Pierna derecha		1PC
3	Bottom Rail / Rail inférieur / Riel inferior		1PC
4	Mending plate / Plaque de réparation / Placa de reparación		2PCS
5	KING SHUTTER PANEL BED FOOTBOARD		1PC
6	QUEEN/KING SHUTTER PANEL BED RAILS		2PCS



NOTE:
ASSEMBLE UNIT ON A SOFT SURFACE.
ASSEMBLEZ L'UNITÉ SUR UNE SURFACE MOLLE.
ENSAMBLE LA UNIDAD EN UNA SUPERFICIE PLANA Y SUAVE.

DO NOT TIGHTEN BOLTS UNTIL THE UNIT IS COHMPLETELY ASSEMBLED.
NE SERREZ PAS LES BOULONS JUSQU'À CE QUE L'UNITÉ SOIT COHMPLÈTEMENT ASSEMBLÉE.
NO APRIETE LOS TORNILLOS HASTA QUE LA UNIDAD ESTE COHMPLETAMENTE ENSAMBLADA.

ASSEMBLY INSTRUCTIONS INSTRUCTIONS DE MONTAGE INSTRUCCIONES DE MONTAJE

KING SHUTTER PANEL BED HB
KING SHUTTER PANEL BED FB
QUEEN/KING SHUTTER PANEL BED RS

LIST OF PARTS AND HARDWARE/ LISTE DES PIÈCES ET DU MATÉRIEL/ LISTA DE PIEZAS Y HARDWARE

NO#/ NOMBRE/ NÚMERO	DESCRIPTION/ DESCRIPTION/ DESCRIPCIÓN		QUANTITY/ QUANTITÉ/ CANTIDAD
7	Slat / Latte / Listón	 1952x76x18mm	4PCS
8	Slat Support / Support de lattes / soporte de lamas	 221x34x34mm	12PCS

Note:

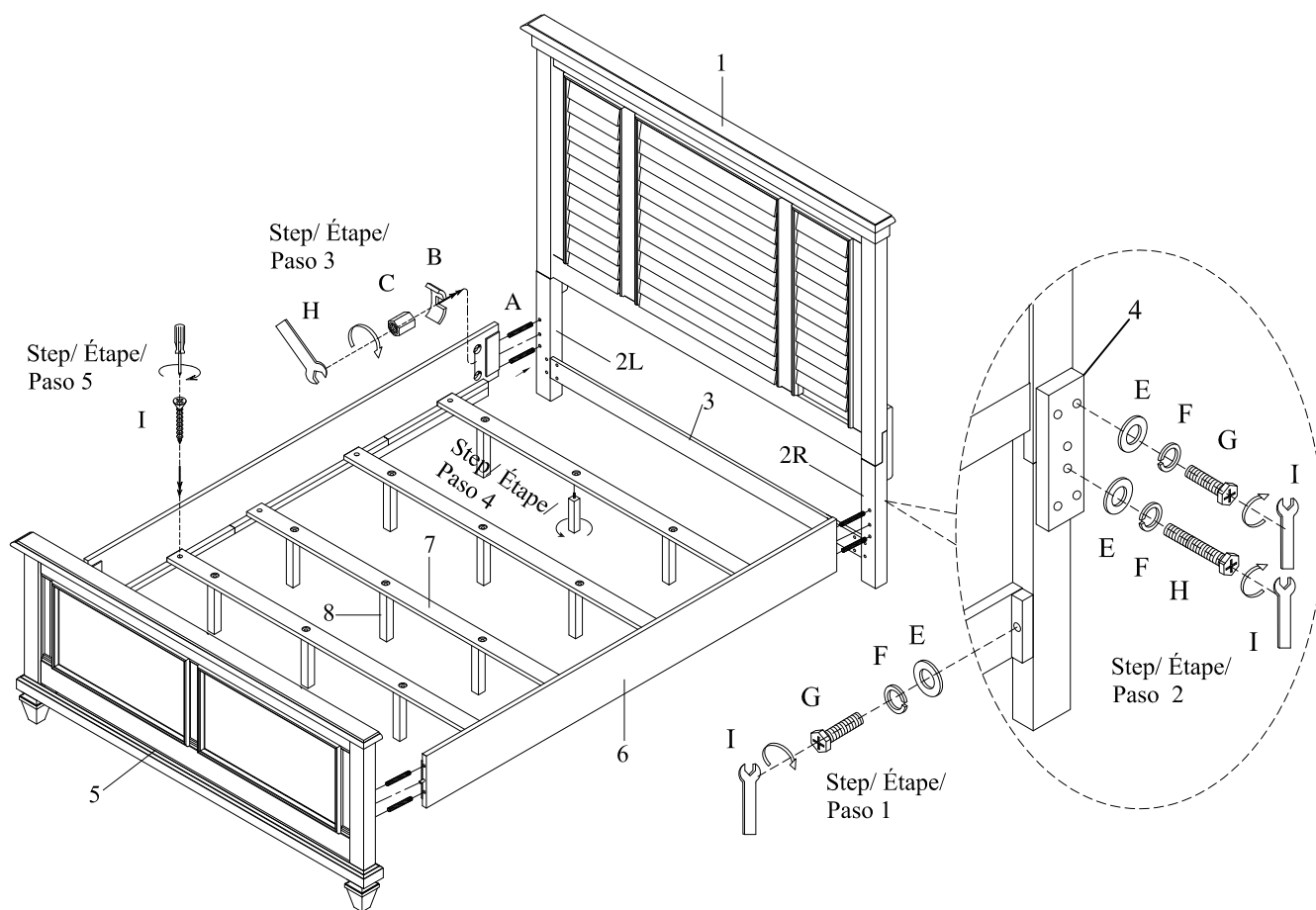
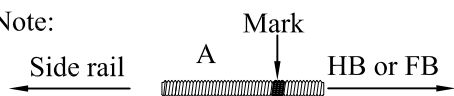

ASSEMBLY INSTRUCTIONS INSTRUCTIONS DE MONTAGE INSTRUCCIONES DE MONTAJE

QUEEN SHUTTER PANEL BED HB
QUEEN SHUTTER PANEL BED HB
QUEEN/KING SHUTTER PANEL BED RS









CAUTION: PLEASE READ ALL INSTRUCTIONS BEFORE STARTING THE ASSEMBLY OF THIS PRODUCT. THESE PIECES ARE HEAVY. IN ORDER TO PREVENT PERSONAL INJURY AND ENSURE THAT THIS PRODUCT IS NOT DAMAGED DURING THE ASSEMBLY PROCESS, IT IS STRONGLY RECOMMENDED TO ENLIST THE ASSISTANCE OF ONE OR MORE PERSONS. IN CASE OF EXCESS STAIN, WIPE THE BOTTOM OF THE UNIT BEFORE PLACING ON ANY SURFACE.

ATTENTION: VEUILLEZ LIRE TOUTES LES INSTRUCTIONS AVANT DE COMMENCER L'ASSEMBLAGE DE CE PRODUIT. LES PIECES SONT LOURDES. POUR EVITER TOUTE BLESSURE ET POUR VOUS ASSURER QUE LE PRODUIT N'EST PAS ENDOMMAGE' PENDANT L'ASSEMBLAGE, NOUS VOUS RECOMMANDONS DE FAIRE APPEL A UNE OU PLUSIEURS AUTRES PERSONNES. EN CAS DE TACHE EXCESSIVE, ESSUYEZ LE FOND DE L'UNITE' AVANT LE PLACEMENT SUR N'IMPORTE QUELLE SURFACE.







CUIDADO: FAVOR DE LEER TODAS LAS INSTRUCCIONES ANTES DE ENSAMBLAR SU PRODUCTO, ESTAS. PIEZAS SON PESADAS. PARA PREVENIR HERIDAS PERSONALES Y ASEGURAR QUE SU PRODUCTO NO SEA DAN ADO MIENTRAS ES ENSAMBLADO. SE RECOMIENDA LA ASISTENCIA DE UNA O MAUS PERSONAS.

WARNING: PROTECTIVE GLIDE IS PLACED UNDER EACH LEG OF THE FURNITURE TO RESIST SCRATCHES ON FLOOR SURFACE. SOME FLOOR SURFACES CAN BE EXTRA SENSITIVE TO SCRATCHES AND MARKINGS, IF YOU ARE NOT SURE CONSULT WITH YOUR DEALER. AVERTISSEMENT. LES PIEDS DES MEUBLES SONT MUNIS DE PATINS DESTINES A PROTEGER LE PLANCHER. CERTAINS REVETEMENTS DE SOL PEUVENT ETRE TRES FRAGILES. EN CAS DE DOUTE. CONSULTER LE MARCHAND.

LIST OF PARTS AND HARDWARE/ LISTE DES PIÈCES ET DU MATÉRIEL/ LISTA DE PIEZAS Y HARDWARE

NO#/ NOMBRE/ NÚMERO	DESCRIPTION/ DESCRIPTION/ DESCRIPCIÓN		QUANTITY/ QUANTITÉ/ CANTIDAD
A	Bolt/ Boulon/ Tornillo	Ø5/16"-18x4 1/2"L	 8PCS
B	Lock washer "C" / Rondelle de blocage "C" / Arandela de bloqueo "C"	Ø5/16"	 8PCS
C	Nut/ Écrou /Nuez	Ø5/16"	 8PCS
D	Flat washer/ Rondelle plate/ Arandela plana	Ø5/16"	 14PCS
E	Lock washer/ Rondelle de blocage/ Arandela de bloqueo	Ø5/16"	 14PCS
F	Bolt/ Boulon/ Tornillo	Ø5/16"-18x2"L	 10PCS
G	Bolt/ Boulon/ Tornillo	Ø5/16"-18x3 1/4"L	 4PCS
H	Wrench / Clé/ Llave inglesa	1/2"	 1PCS
I	Screw / Vis / tornillo de punta	M4-8x1"	 8PCS

LIST OF PARTS AND HARDWARE/ LISTE DES PIÈCES ET DU MATÉRIEL/ LISTA DE PIEZAS Y HARDWARE

NO#/ NOMBRE/ NÚMERO	DESCRIPTION/ DESCRIPTION/ DESCRIPCIÓN		QUANTITY/ QUANTITÉ/ CANTIDAD
1	QUEEN SHUTTER PANEL BED HEADBOARD		1PC
2L	Left Leg / Patte gauche / Pierna izquierda		1PC
2R	Right Leg / Patte droite / Pierna derecha		1PC
3	Bottom Rail / Rail inférieur / Riel inferior		1PC
4	Mending plate / Plaque de réparation / Placa de reparación		2PCS
5	QUEEN SHUTTER PANEL BED FOOTBOARD		1PC
6	QUEEN/KING SHUTTER PANEL BED RAILS		2PCS



NOTE:
ASSEMBLE UNIT ON A SOFT SURFACE.
ASSEMBLEZ L'UNITÉ SUR UNE SURFACE MOLLE.
ENSAMBLE LA UNIDAD EN UNA SUPERFICIE PLANA Y SUAVE.

DO NOT TIGHTEN BOLTS UNTIL THE UNIT IS COHMPLETELY ASSEMBLED.
NE SERREZ PAS LES BOULONS JUSQU'À CE QUE L'UNITÉ SOIT COHMPLÈTEMENT ASSEMBLÉE.
NO APRIETE LOS TORNILLOS HASTA QUE LA UNIDAD ESTE COHMPLETAMENTE ENSAMBLADA.

ASSEMBLY INSTRUCTIONS INSTRUCTIONS DE MONTAGE INSTRUCCIONES DE MONTAJE

QUEEN SHUTTER PANEL BED HB
QUEEN SHUTTER PANEL BED HB
QUEEN/KING SHUTTER PANEL BED RS

LIST OF PARTS AND HARDWARE/ LISTE DES PIÈCES ET DU MATÉRIEL/ LISTA DE PIEZAS Y HARDWARE

NO#/ NOMBRE/ NÚMERO	DESCRIPTION/ DESCRIPTION/ DESCRIPCIÓN		QUANTITY/ QUANTITÉ/ CANTIDAD
7	Slat / Latte / Listón	 1545x76x18mm	4PCS
8	Slat Support / Support de lattes / soporte de lamas	 221x34x34mm	4PCS

Note:

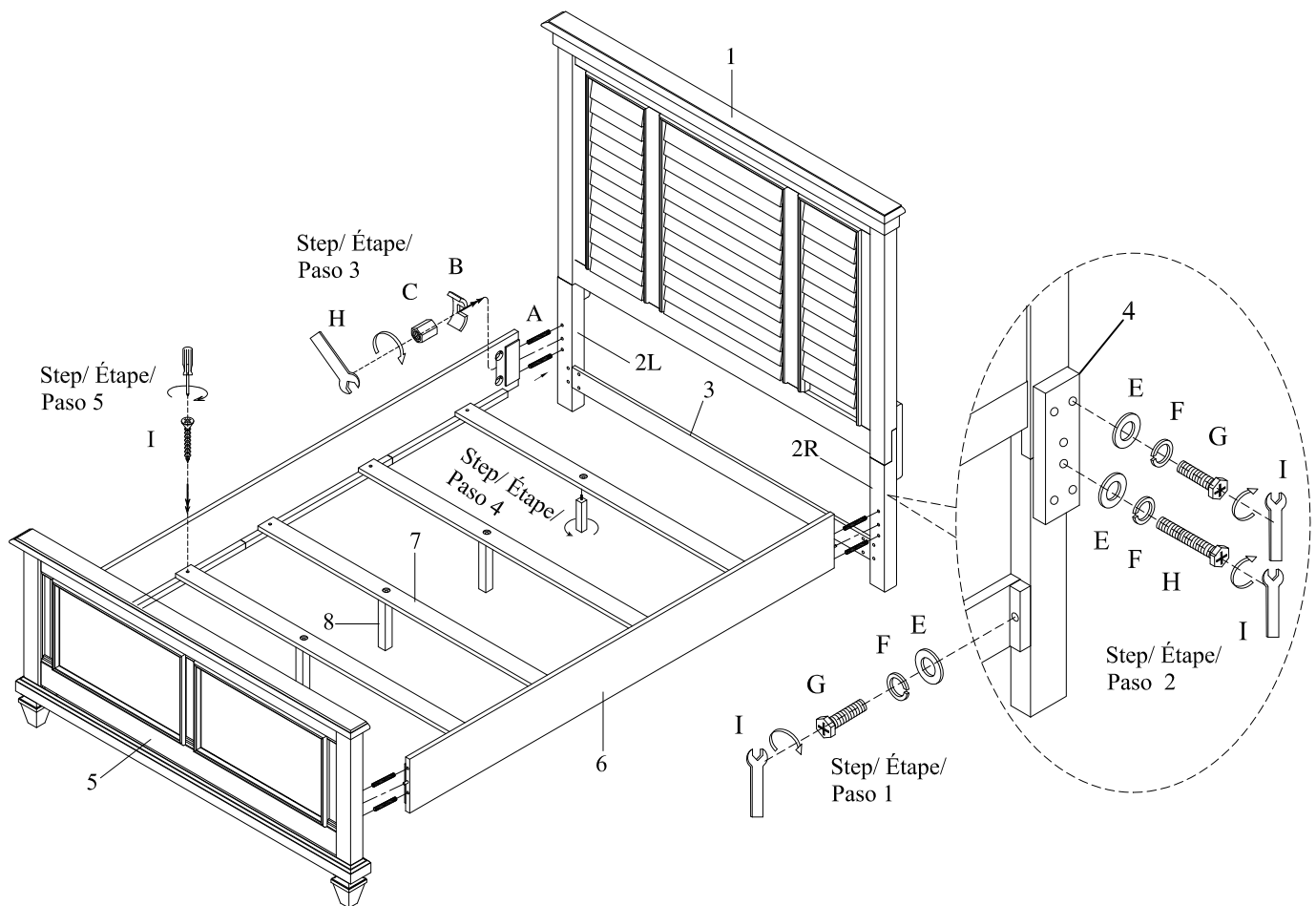
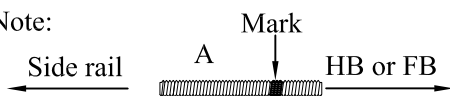

ASSEMBLY INSTRUCTIONS INSTRUCTIONS DE MONTAGE INSTRUCCIONES DE MONTAJE

DRAWER DRESSER MIRROR





CAUTION: PLEASE READ ALL INSTRUCTIONS BEFORE STARTING THE ASSEMBLY OF THIS PRODUCT. THESE PIECES ARE HEAVY. IN ORDER TO PREVENT PERSONAL INJURY AND ENSURE THAT THIS PRODUCT IS NOT DAMAGED DURING THE ASSEMBLY PROCESS, IT IS STRONGLY RECOMMENDED TO ENLIST THE ASSISTANCE OF ONE OR MORE PERSONS. IN CASE OF EXCESS STAIN, WIPE THE BOTTOM OF THE UNIT BEFORE PLACING ON ANY SURFACE.

ATTENTION: VEUILLEZ LIRE TOUTES LES INSTRUCTIONS AVANT DE COMMENCER L'ASSEMBLAGE DE CE PRODUIT. LES PIÉCES SONT LOURDES. POUR ÉVITER TOUTE BLESSURE ET POUR VOUS ASSURER QUE LE PRODUIT N'EST PAS ENDOMMAGÉ PENDANT L'ASSEMBLAGE, NOUS VOUS RECOMMANDONS DE FAIRE APPEL À UNE OU PLUSIEURS AUTRES PERSONNES. EN CAS DE TACHE EXCESSIVE, ESSUYEZ LE FOND DE L'UNITÉ AVANT LE PLACEMENT SUR N'IMPORTE QUELLE SURFACE.



CUIDADO: FAVOR DE LEER TODAS LAS INSTRUCCIONES ANTES DE ENSAMBLAR SU PRODUCTO, ESTAS PIEZAS SON PESADAS. PARA PREVENIR HERIDAS PERSONALES Y ASEGURAR QUE SU PRODUCTO NO SEA DAÑADO MIENTRAS ES ENSAMBLADO. SE RECOMIENDA LA ASISTENCIA DE UNA O MÁS PERSONAS.

WARNING: PROTECTIVE GLIDE IS PLACED UNDER EACH LEG OF THE FURNITURE TO RESIST SCRATCHES ON FLOOR SURFACE. SOME FLOOR SURFACES CAN BE EXTRA SENSITIVE TO SCRATCHES AND MARKINGS, IF YOU ARE NOT SURE CONSULT WITH YOUR DEALER. AVERTISSEMENT. LES PIEDS DES MEUBLES SONT MUNIS DE PATINS DESTINÉS À PROTÉGER LE PLANCHER. CERTAINS REVÊTEMENTS DE SOL PEUVENT ÊTRE TRÈS FRAGILES. EN CAS DE DOUTE, CONSULTER LE MARCHAND.

LIST OF PARTS AND HARDWARE/ LISTE DES PIÈCES ET DU MATÉRIEL/ LISTA DE PIEZAS Y HARDWARE

No#/ NOMBRE/ NÚMERO	DESCRIPTION/ DESCRIPTION/ DESCRIPCIÓN		QUANTITY/ QUANTITÉ/ CANTIDAD
A	Flat washer/ Rondelle plate/ Arandela plana	Ø1/4"	 8PCS
B	Lock washer/ Rondelle de blocage/ Arandela de bloqueo	Ø1/4"	 8PCS
C	Bolt/ Boulon/ Tornillo	Ø1/4"-20x2"L	 8PCS
D	Allen Key / Clé Allen / Llave Allen	1/6"	 1PC

LIST OF PARTS AND HARDWARE/ LISTE DES PIÈCES ET DU MATÉRIEL/ LISTA DE PIEZAS Y HARDWARE

No#/ NOMBRE/ NÚMERO	DESCRIPTION/ DESCRIPTION/ DESCRIPCIÓN		QUANTITY/ QUANTITÉ/ CANTIDAD
1	MIRROR		1PC
2	Mirror Support Rail / Rail de soutien du miroir / soporte para espejo		2PCS
3	DRAWER DRESSER		1PC

NOTE:
ASSEMBLE UNIT ON A SOFT SURFACE.
ASSEMBLEZ L'UNITÉ SUR UNE SURFACE MOLLE.
ENSAMBLE LA UNIDAD EN UNA SUPERFICIE PLANA Y SUAVE.

DO NOT TIGHTEN BOLTS UNTIL THE UNIT IS COMPLETELY ASSEMBLED.
NE SERREZ PAS LES BOULONS JUSQU'À CE QUE L'UNITÉ SOIT COMPLÈTEMENT ASSEMBLÉE.
NO APRIETE LOS TORNILLOS HASTA QUE LA UNIDAD ESTE COMPLETAMENTE ENSAMBLADA.

ASSEMBLY INSTRUCTIONS
INSTRUCTIONS DE MONTAGE
INSTRUCCIONES DE MONTAJE
DRAWER DRESSER
MIRROR

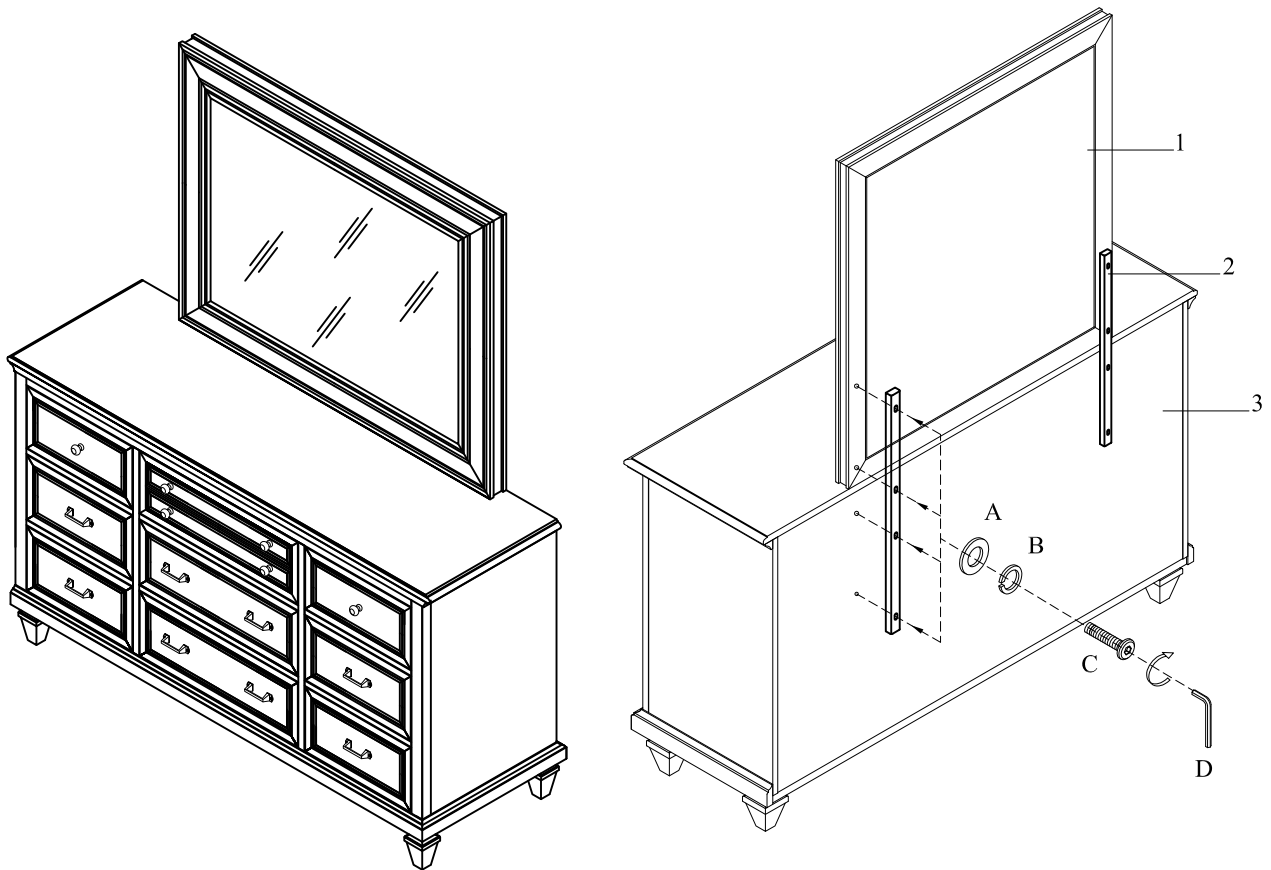

ASSEMBLY INSTRUCTIONS INSTRUCTIONS DE MONTAGE INSTRUCCIONES DE MONTAJE









QUEEN PANEL BED HEADBOARD
QUEEN PANEL BED FOOTBOARD
QUEEN/KING PANEL BED RAILS



CAUTION: PLEASE READ ALL INSTRUCTIONS BEFORE STARTING THE ASSEMBLY OF THIS PRODUCT. THESE PIECES ARE HEAVY. IN ORDER TO PREVENT PERSONAL INJURY AND ENSURE THAT THIS PRODUCT IS NOT DAMAGED DURING THE ASSEMBLY PROCESS, IT IS STRONGLY RECOMMENDED TO ENLIST THE ASSISTANCE OF ONE OR MORE PERSONS. IN CASE OF EXCESS STAIN, WIPE THE BOTTOM OF THE UNIT BEFORE PLACING ON ANY SURFACE.

ATTENTION: VEUILLEZ LIRE TOUTES LES INSTRUCTIONS AVANT DE COMMENCER L'ASSEMBLAGE DE CE PRODUIT. LES PIECES SONT LOURDES. POUR EVITER TOUTE BLESSURE ET POUR VOUS ASSURER QUE LE PRODUIT N'EST PAS ENDOMMAGE' PENDANT L'ASSEMBLAGE, NOUS VOUS RECOMMANDONS DE FAIRE APPEL A UNE OU PLUSIEURS AUTRES PERSONNES. EN CAS DE TACHE EXCESSIVE, ESSUYEZ LE FOND DE L'UNITE' AVANT LE PLACEMENT SUR N'IMPORTE QUELLE SURFACE.

CUIDADO: FAVOR DE LEER TODAS LAS INSTRUCCIONES ANTES DE ENSAMBLAR SU PRODUCTO, ESTAS. PIEZAS SON PESADAS. PARA PREVENIR HERIDAS PERSONALES Y ASEGURAR QUE SU PRODUCTO NO SEA DAN ADO MIENTRAS ES ENSAMBLADO. SE RECOMIENDA LA ASISTENCIA DE UNA O MAUS PERSONAS.

WARNING: PROTECTIVE GLIDE IS PLACED UNDER EACH LEG OF THE FURNITURE TO RESIST SCRATCHES ON FLOOR SURFACE. SOME FLOOR SURFACES CAN BE EXTRA SENSITIVE TO SCRATCHES AND MARKINGS, IF YOU ARE NOT SURE CONSULT WITH YOUR DEALER. AVERTISSEMENT. LES PIEDS DES MEUBLES SONT MUNIS DE PATINS DESTINES A PROTEGER LE PLANCHER. CERTAINS REVETEMENTS DE SOL PEUVENT ETRE TRES FRAGILES. EN CAS DE DOUTE. CONSULTER LE MARCHAND.

LIST OF PARTS AND HARDWARE/ LISTE DES PIÈCES ET DU MATÉRIEL/ LISTA DE PIEZAS Y HARDWARE				
NO#/ NOMBRE/ NÚMERO	DESCRIPTION/ DESCRIPTION/ DESCRIPCIÓN			QUANTITY/ QUANTITÉ/ CANTIDAD
A	Bolt/ Boulon/ Tornillo	Ø5/16"-18x4 1/2"L		8PCS
B	Nut/ Écrou /Nuez	Ø5/16"		8PCS
C	Lock washer "C" / Rondelle de blocage "C" / Arandela de bloqueo "C"	Ø5/16"		8PCS
D	Screw / Vis / tornillo de punta	M4-8x1"		8PCS
E	Flat washer/ Rondelle plate/ Arandela plana	Ø5/16"		14PCS
F	Lock washer/ Rondelle de blocage/ Arandela de bloqueo	Ø5/16"		14PCS
G	Bolt/ Boulon/ Tornillo	Ø5/16"-18x2"L		10PCS
H	Bolt/ Boulon/ Tornillo	Ø5/16"-18x3 1/4"L		4PCS
I	Wrench / Clé/ Llave inglesa	1/2"		1PC

LIST OF PARTS AND HARDWARE/ LISTE DES PIÈCES ET DU MATÉRIEL/ LISTA DE PIEZAS Y HARDWARE				
NO#/ NOMBRE/ NÚMERO	DESCRIPTION/ DESCRIPTION/ DESCRIPCIÓN			QUANTITY/ QUANTITÉ/ CANTIDAD
1	QUEEN PANEL BED HEADBOARD			1PC
2L	Left Leg / Patte gauche / Pierna izquierda			1PC
2R	Right Leg / Patte droite / Pierna derecha			1PC
3	QUEEN PANEL BED FOOTBOARD			1PC
4	QUEEN/KING PANEL BED RAILS			2PCS
5	Slat / Latte / Listón	1545x76x18mm		4PCS
6	Slat Support / Support de lattes / soporte de lamas	221x34x34mm		4PCS



NOTE:
ASSEMBLE UNIT ON A SOFT SURFACE.
ASSEMBLEZ L'UNITÉ SUR UNE SURFACE MOLLE.
ENSAMBLE LA UNIDAD EN UNA SUPERFICIE PLANA Y SUAVE.

DO NOT TIGHTEN BOLTS UNTIL THE UNIT IS COHMPLETELY ASSEMBLED.
NE SERREZ PAS LES BOULONS JUSQU'À CE QUE L'UNITÉ SOIT COHMPLÈTEMENT ASSEMBLÉE.
NO APRIETE LOS TORNILLOS HASTA QUE LA UNIDAD ESTE COHMPLETAMENTE ENSAMBLADA.

ASSEMBLY INSTRUCTIONS INSTRUCTIONS DE MONTAGE INSTRUCCIONES DE MONTAJE

QUEEN PANEL BED HEADBOARD
QUEEN PANEL BED FOOTBOARD
QUEEN/KING PANEL BED RAILS

LIST OF PARTS AND HARDWARE/ LISTE DES PIÈCES ET DU MATÉRIEL/ LISTA DE PIEZAS Y HARDWARE

NO#/ NOMBRE/ NÚMERO	DESCRIPTION/ DESCRIPTION/ DESCRIPCIÓN		QUANTITY/ QUANTITÉ/ CANTIDAD
7	Bottom Rail / Rail inférieur / Riel inferior		1PC
8	Mending plate / Plaque de réparation / Placa de reparación		2PCS

Note:

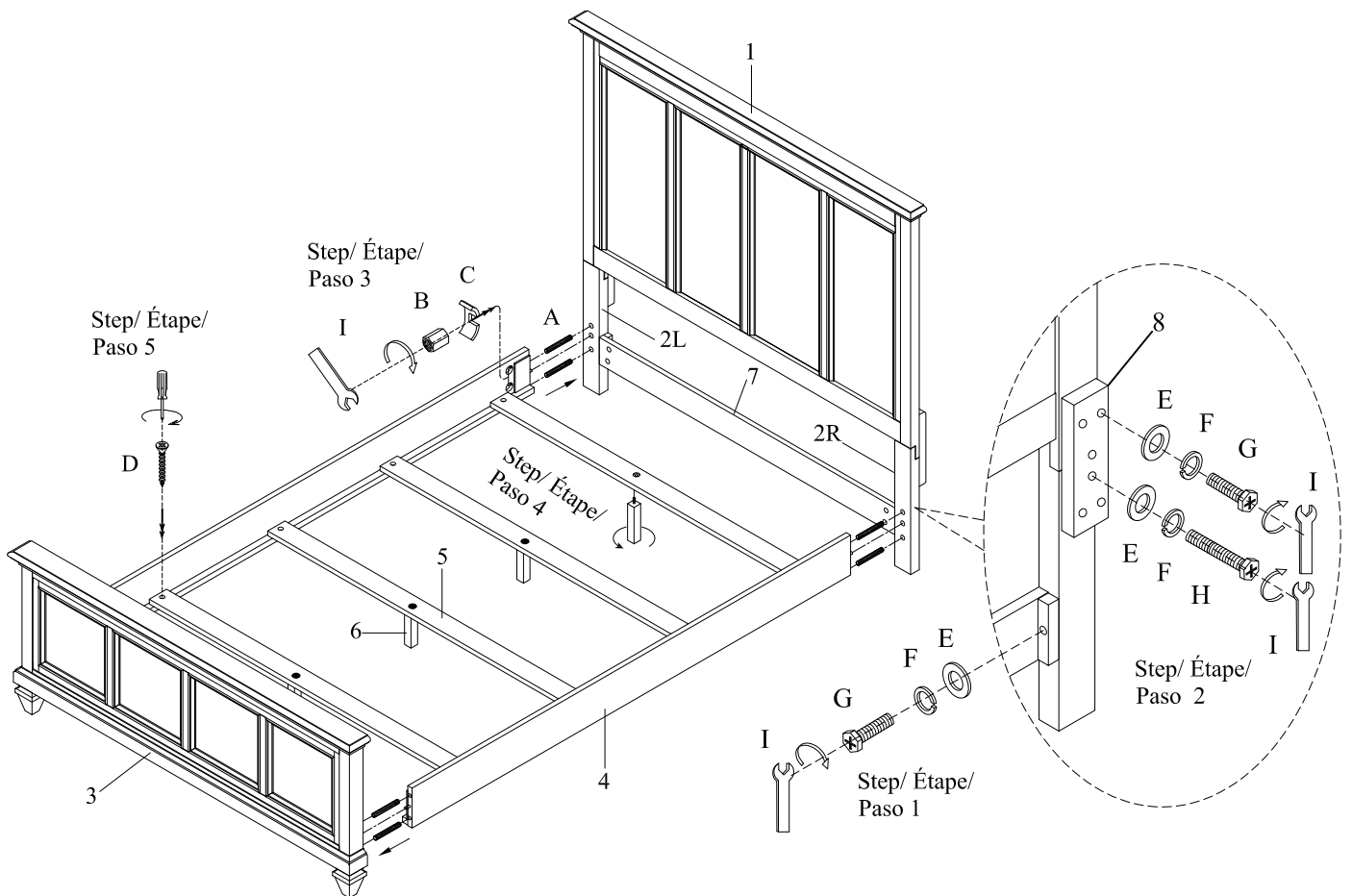
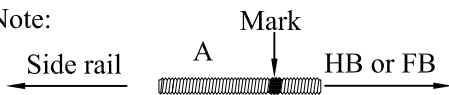

ASSEMBLY INSTRUCTIONS INSTRUCTIONS DE MONTAGE INSTRUCCIONES DE MONTAJE

KING PANEL BED HEADBOARD
KING PANEL BED FOOTBOARD
QUEEN/KING PANEL BED RAILS









CAUTION: PLEASE READ ALL INSTRUCTIONS BEFORE STARTING THE ASSEMBLY OF THIS PRODUCT. THESE PIECES ARE HEAVY. IN ORDER TO PREVENT PERSONAL INJURY AND ENSURE THAT THIS PRODUCT IS NOT DAMAGED DURING THE ASSEMBLY PROCESS, IT IS STRONGLY RECOMMENDED TO ENLIST THE ASSISTANCE OF ONE OR MORE PERSONS. IN CASE OF EXCESS STAIN, WIPE THE BOTTOM OF THE UNIT BEFORE PLACING ON ANY SURFACE.

ATTENTION: VEUILLEZ LIRE TOUTES LES INSTRUCTIONS AVANT DE COMMENCER L'ASSEMBLAGE DE CE PRODUIT. LES PIECES SONT LOURDES. POUR EVITER TOUTE BLESSURE ET POUR VOUS ASSURER QUE LE PRODUIT N'EST PAS ENDOMMAGE' PENDANT L'ASSEMBLAGE, NOUS VOUS RECOMMANDONS DE FAIRE APPEL A UNE OU PLUSIEURS AUTRES PERSONNES. EN CAS DE TACHE EXCESSIVE, ESSUYEZ LE FOND DE L'UNITE' AVANT LE PLACEMENT SUR N'IMPORTE QUELLE SURFACE.







CUIDADO: FAVOR DE LEER TODAS LAS INSTRUCCIONES ANTES DE ENSAMBLAR SU PRODUCTO, ESTAS. PIEZAS SON PESADAS. PARA PREVENIR HERIDAS PERSONALES Y ASEGURAR QUE SU PRODUCTO NO SEA DAN ADO MIENTRAS ES ENSAMBLADO. SE RECOMIENDA LA ASISTENCIA DE UNA O MAUS PERSONAS.

WARNING: PROTECTIVE GLIDE IS PLACED UNDER EACH LEG OF THE FURNITURE TO RESIST SCRATCHES ON FLOOR SURFACE. SOME FLOOR SURFACES CAN BE EXTRA SENSITIVE TO SCRATCHES AND MARKINGS, IF YOU ARE NOT SURE CONSULT WITH YOUR DEALER. AVERTISSEMENT. LES PIEDS DES MEUBLES SONT MUNIS DE PATINS DESTINES A PROTEGER LE PLANCHER. CERTAINS REVETEMENTS DE SOL PEUVENT ETRE TRES FRAGILES. EN CAS DE DOUTE. CONSULTER LE MARCHAND.

LIST OF PARTS AND HARDWARE/ LISTE DES PIÈCES ET DU MATÉRIEL/ LISTA DE PIEZAS Y HARDWARE

NO#/ NOMBRE/ NÚMERO	DESCRIPTION/ DESCRIPTION/ DESCRIPCIÓN		QUANTITY/ QUANTITÉ/ CANTIDAD
A	Bolt/ Boulon/ Tornillo	Ø5/16"-18x4 1/2"L	 8PCS
B	Nut/ Écrou /Nuez	Ø5/16"	 8PCS
C	Lock washer "C" / Rondelle de blocage "C" / Arandela de bloqueo "C"	Ø5/16"	 8PCS
D	Screw / Vis / tornillo de punta	M4-8x1"	 8PCS
E	Flat washer/ Rondelle plate/ Arandela plana	Ø5/16"	 14PCS
F	Lock washer/ Rondelle de blocage/ Arandela de bloqueo	Ø5/16"	 14PCS
G	Bolt/ Boulon/ Tornillo	Ø5/16"-18x2"L	 10PCS
H	Bolt/ Boulon/ Tornillo	Ø5/16"-18x3 1/4"L	 4PCS
I	Wrench / Clé/ Llave inglesa	1/2"	 1PC

LIST OF PARTS AND HARDWARE/ LISTE DES PIÈCES ET DU MATÉRIEL/ LISTA DE PIEZAS Y HARDWARE

NO#/ NOMBRE/ NÚMERO	DESCRIPTION/ DESCRIPTION/ DESCRIPCIÓN		QUANTITY/ QUANTITÉ/ CANTIDAD
1	KING PANEL BED HEADBOARD		1PC
2L	Left Leg / Patte gauche / Pierna izquierda		1PC
2R	Right Leg / Patte droite / Pierna derecha		1PC
3	KING PANEL BED FOOTBOARD		1PC
4	QUEEN/KING PANEL BED RAILS		2PCS
5	Slat / Latte / Listón	 1952x76x18mm	4PCS
6	Slat Support / Support de lattes / soporte de lamas	 221x34x34mm	12PCS



NOTE:
ASSEMBLE UNIT ON A SOFT SURFACE.
ASSEMBLEZ L'UNITÉ SUR UNE SURFACE MOLLE.
ENSAMBLE LA UNIDAD EN UNA SUPERFICIE PLANA Y SUAVE.

DO NOT TIGHTEN BOLTS UNTIL THE UNIT IS COHMPLETELY ASSEMBLED.
NE SERREZ PAS LES BOULONS JUSQU'À CE QUE L'UNITÉ SOIT COHMPLÈTEMENT ASSEMBLÉE.
NO APRIETE LOS TORNILLOS HASTA QUE LA UNIDAD ESTE COHMPLETAMENTE ENSAMBLADA.

ASSEMBLY INSTRUCTIONS INSTRUCTIONS DE MONTAGE INSTRUCCIONES DE MONTAJE

KING PANEL BED HEADBOARD
KING PANEL BED FOOTBOARD
QUEEN/KING PANEL BED RAILS

LIST OF PARTS AND HARDWARE/ LISTE DES PIÈCES ET DU MATÉRIEL/ LISTA DE PIEZAS Y HARDWARE

NO#/ NOMBRE/ NÚMERO	DESCRIPTION/ DESCRIPTION/ DESCRIPCIÓN		QUANTITY/ QUANTITÉ/ CANTIDAD
7	Bottom Rail / Rail inférieur / Riel inferior		1PC
8	Mending plate / Plaque de réparation / Placa de reparación		2PCS

Note:

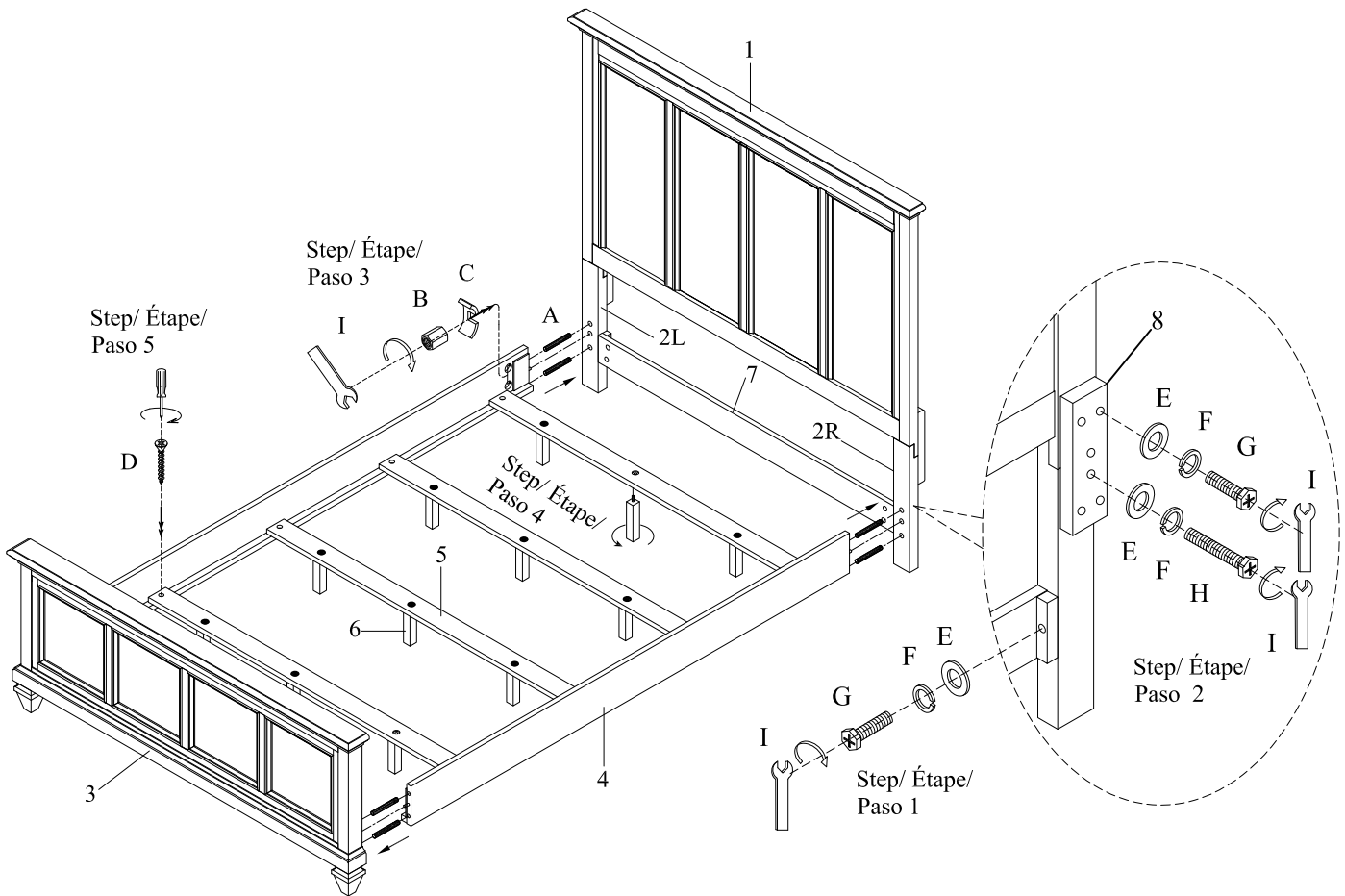
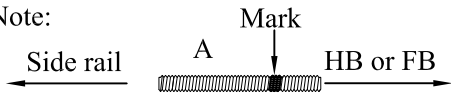

ASSEMBLY INSTRUCTIONS INSTRUCTIONS DE MONTAGE INSTRUCCIONES DE MONTAJE

KING PANEL BED HEADBOARD
KING PANEL BED FOOTBOARD
CAL. KING PANEL BED









CAUTION: PLEASE READ ALL INSTRUCTIONS BEFORE STARTING THE ASSEMBLY OF THIS PRODUCT. THESE PIECES ARE HEAVY. IN ORDER TO PREVENT PERSONAL INJURY AND ENSURE THAT THIS PRODUCT IS NOT DAMAGED DURING THE ASSEMBLY PROCESS, IT IS STRONGLY RECOMMENDED TO ENLIST THE ASSISTANCE OF ONE OR MORE PERSONS. IN CASE OF EXCESS STAIN, WIPE THE BOTTOM OF THE UNIT BEFORE PLACING ON ANY SURFACE.

ATTENTION: VEUILLEZ LIRE TOUTES LES INSTRUCTIONS AVANT DE COMMENCER L'ASSEMBLAGE DE CE PRODUIT. LES PIECES SONT LOURDES. POUR EVITER TOUTE BLESSURE ET POUR VOUS ASSURER QUE LE PRODUIT N'EST PAS ENDOMMAGE' PENDANT L'ASSEMBLAGE, NOUS VOUS RECOMMANDONS DE FAIRE APPEL A UNE OU PLUSIEURS AUTRES PERSONNES. EN CAS DE TACHE EXCESSIVE, ESSUYEZ LE FOND DE L'UNITE' AVANT LE PLACEMENT SUR N'IMPORTE QUELLE SURFACE.







CUIDADO: FAVOR DE LEER TODAS LAS INSTRUCCIONES ANTES DE ENSAMBLAR SU PRODUCTO, ESTAS. PIEZAS SON PESADAS. PARA PREVENIR HERIDAS PERSONALES Y ASEGURAR QUE SU PRODUCTO NO SEA DAN ADO MIENTRAS ES ENSAMBLADO. SE RECOMIENDA LA ASISTENCIA DE UNA O MAUS PERSONAS.

WARNING: PROTECTIVE GLIDE IS PLACED UNDER EACH LEG OF THE FURNITURE TO RESIST SCRATCHES ON FLOOR SURFACE. SOME FLOOR SURFACES CAN BE EXTRA SENSITIVE TO SCRATCHES AND MARKINGS, IF YOU ARE NOT SURE CONSULT WITH YOUR DEALER. AVERTISSEMENT. LES PIEDS DES MEUBLES SONT MUNIS DE PATINS DESTINES A PROTEGER LE PLANCHER. CERTAINS REVETEMENTS DE SOL PEUVENT ETRE TRES FRAGILES. EN CAS DE DOUTE. CONSULTER LE MARCHAND.

LIST OF PARTS AND HARDWARE/ LISTE DES PIÈCES ET DU MATÉRIEL/ LISTA DE PIEZAS Y HARDWARE

NO#/ NOMBRE/ NÚMERO	DESCRIPTION/ DESCRIPTION/ DESCRIPCIÓN		QUANTITY/ QUANTITÉ/ CANTIDAD
A	Bolt/ Boulon/ Tornillo	Ø5/16"-18x4 1/2"L	 8PCS
B	Nut/ Écrou /Nuez	Ø5/16"	 8PCS
C	Lock washer "C" / Rondelle de blocage "C" / Arandela de bloqueo "C"	Ø5/16"	 8PCS
D	Screw / Vis / tornillo de punta	M4-8x1"	 8PCS
E	Flat washer/ Rondelle plate/ Arandela plana	Ø5/16"	 14PCS
F	Lock washer/ Rondelle de blocage/ Arandela de bloqueo	Ø5/16"	 14PCS
G	Bolt/ Boulon/ Tornillo	Ø5/16"-18x2"L	 10PCS
H	Bolt/ Boulon/ Tornillo	Ø5/16"-18x3 1/4"L	 4PCS
I	Wrench / Clé/ Llave inglesa	1/2"	 1PC

LIST OF PARTS AND HARDWARE/ LISTE DES PIÈCES ET DU MATÉRIEL/ LISTA DE PIEZAS Y HARDWARE

NO#/ NOMBRE/ NÚMERO	DESCRIPTION/ DESCRIPTION/ DESCRIPCIÓN		QUANTITY/ QUANTITÉ/ CANTIDAD
1	KING PANEL BED HEADBOARD		1PC
2L	Left Leg / Patte gauche / Pierna izquierda		1PC
2R	Right Leg / Patte droite / Pierna derecha		1PC
3	KING PANEL BED FOOTBOARD		1PC
4	CAL. KING PANEL BED		2PCS
5	Slat / Latte / Listón	 1952x76x18mm	4PCS
6	Slat Support / Support de lattes / soporte de lamas	 221x34x34mm	12PCS



NOTE:
ASSEMBLE UNIT ON A SOFT SURFACE.
ASSEMBLEZ L'UNITÉ SUR UNE SURFACE MOLLE.
ENSAMBLE LA UNIDAD EN UNA SUPERFICIE PLANA Y SUAVE.

DO NOT TIGHTEN BOLTS UNTIL THE UNIT IS COHMPLETELY ASSEMBLED.
NE SERREZ PAS LES BOULONS JUSQU'À CE QUE L'UNITÉ SOIT COHMPLÈTEMENT ASSEMBLÉE.
NO APRIETE LOS TORNILLOS HASTA QUE LA UNIDAD ESTE COHMPLETAMENTE ENSAMBLADA.

ASSEMBLY INSTRUCTIONS INSTRUCTIONS DE MONTAGE INSTRUCCIONES DE MONTAJE

KING PANEL BED HEADBOARD
KING PANEL BED FOOTBOARD
CAL. KING PANEL BED

LIST OF PARTS AND HARDWARE/ LISTE DES PIÈCES ET DU MATÉRIEL/ LISTA DE PIEZAS Y HARDWARE

NO#/ NOMBRE/ NÚMERO	DESCRIPTION/ DESCRIPTION/ DESCRIPCIÓN		QUANTITY/ QUANTITÉ/ CANTIDAD
7	Bottom Rail / Rail inférieur / Riel inferior		1PC
8	Mending plate / Plaque de réparation / Placa de reparación		2PCS

Note:

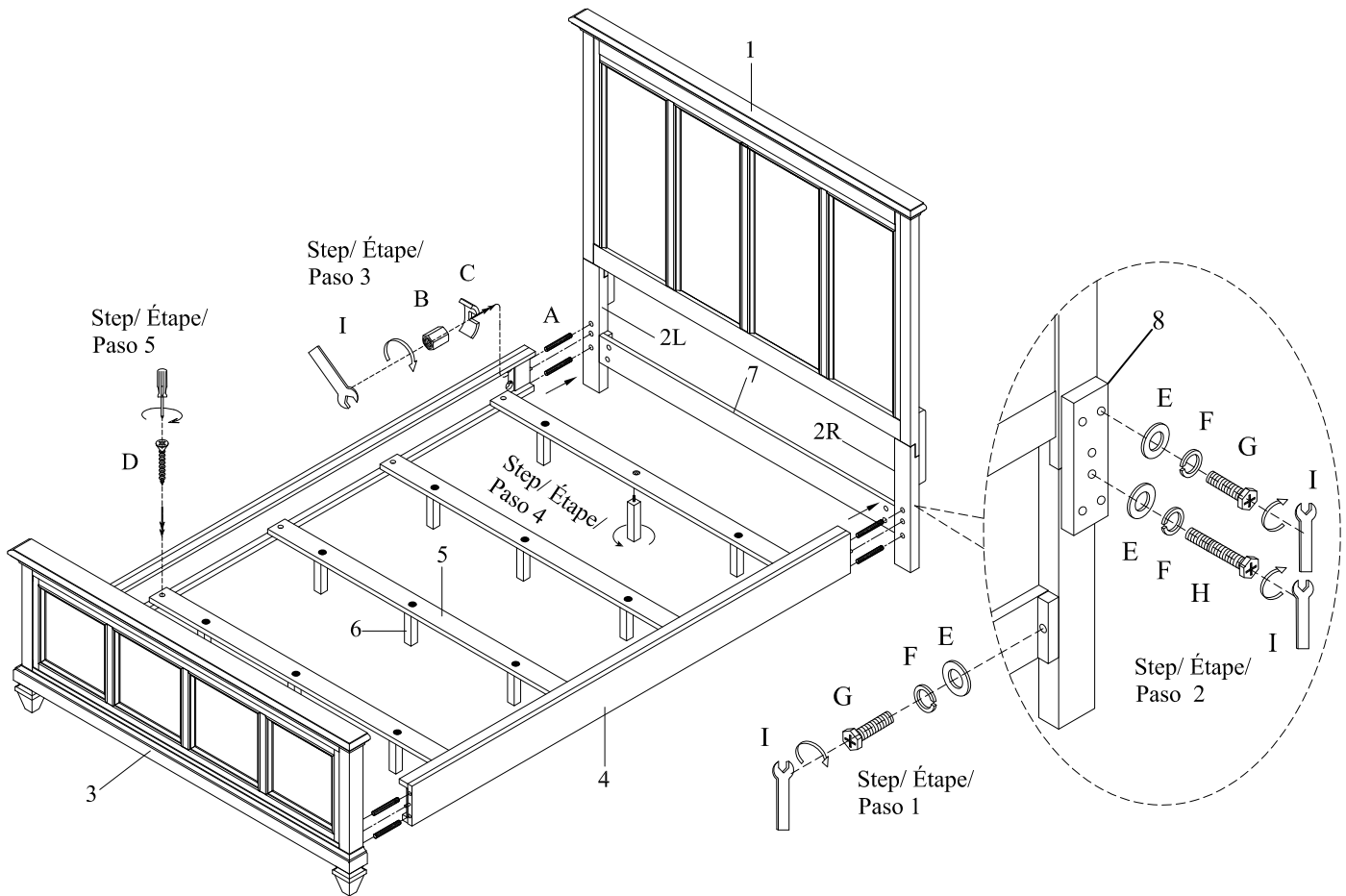
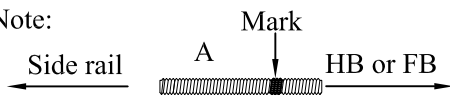

ASSEMBLY INSTRUCTIONS INSTRUCTIONS DE MONTAGE INSTRUCCIONES DE MONTAJE

KING SHUTTER PANEL BED HB
KING SHUTTER PANEL BED FB
CAL KING SHUTTER PANEL BED RS









CAUTION: PLEASE READ ALL INSTRUCTIONS BEFORE STARTING THE ASSEMBLY OF THIS PRODUCT. THESE PIECES ARE HEAVY. IN ORDER TO PREVENT PERSONAL INJURY AND ENSURE THAT THIS PRODUCT IS NOT DAMAGED DURING THE ASSEMBLY PROCESS, IT IS STRONGLY RECOMMENDED TO ENLIST THE ASSISTANCE OF ONE OR MORE PERSONS. IN CASE OF EXCESS STAIN, WIPE THE BOTTOM OF THE UNIT BEFORE PLACING ON ANY SURFACE.

ATTENTION: VEUILLEZ LIRE TOUTES LES INSTRUCTIONS AVANT DE COMMENCER L'ASSEMBLAGE DE CE PRODUIT. LES PIECES SONT LOURDES. POUR EVITER TOUTE BLESSURE ET POUR VOUS ASSURER QUE LE PRODUIT N'EST PAS ENDOMMAGE' PENDANT L'ASSEMBLAGE, NOUS VOUS RECOMMANDONS DE FAIRE APPEL A UNE OU PLUSIEURS AUTRES PERSONNES. EN CAS DE TACHE EXCESSIVE, ESSUYEZ LE FOND DE L'UNITE' AVANT LE PLACEMENT SUR N'IMPORTE QUELLE SURFACE.







CUIDADO: FAVOR DE LEER TODAS LAS INSTRUCCIONES ANTES DE ENSAMBLAR SU PRODUCTO, ESTAS. PIEZAS SON PESADAS. PARA PREVENIR HERIDAS PERSONALES Y ASEGURAR QUE SU PRODUCTO NO SEA DAN ADO MIENTRAS ES ENSAMBLADO. SE RECOMIENDA LA ASISTENCIA DE UNA O MAUS PERSONAS.

WARNING: PROTECTIVE GLIDE IS PLACED UNDER EACH LEG OF THE FURNITURE TO RESIST SCRATCHES ON FLOOR SURFACE. SOME FLOOR SURFACES CAN BE EXTRA SENSITIVE TO SCRATCHES AND MARKINGS, IF YOU ARE NOT SURE CONSULT WITH YOUR DEALER. AVERTISSEMENT. LES PIEDS DES MEUBLES SONT MUNIS DE PATINS DESTINES A PROTEGER LE PLANCHER. CERTAINS REVETEMENTS DE SOL PEUVENT ETRE TRES FRAGILES. EN CAS DE DOUTE. CONSULTER LE MARCHAND.

LIST OF PARTS AND HARDWARE/ LISTE DES PIÈCES ET DU MATÉRIEL/ LISTA DE PIEZAS Y HARDWARE

NO#/ NOMBRE/ NÚMERO	DESCRIPTION/ DESCRIPTION/ DESCRIPCIÓN		QUANTITY/ QUANTITÉ/ CANTIDAD
A	Bolt / Boulon / Tornillo	Ø5/16"-18x4 1/2"L	 8PCS
B	Lock washer "C" / Rondelle de blocage "C" / Arandela de bloqueo "C"	Ø5/16"	 8PCS
C	Nut / Écrou / Nuez	Ø5/16"	 8PCS
D	Flat washer / Rondelle plate / Arandela plana	Ø5/16"	 14PCS
E	Lock washer / Rondelle de blocage / Arandela de bloqueo	Ø5/16"	 14PCS
F	Bolt / Boulon / Tornillo	Ø5/16"-18x2"L	 10PCS
G	Bolt / Boulon / Tornillo	Ø5/16"-18x3 1/4"L	 4PCS
H	Wrench / Clé / Llave inglesa	1/2"	 1PCS
I	Screw / Vis / tornillo de punta	M4-8x1"	 8PCS

LIST OF PARTS AND HARDWARE/ LISTE DES PIÈCES ET DU MATÉRIEL/ LISTA DE PIEZAS Y HARDWARE

NO#/ NOMBRE/ NÚMERO	DESCRIPTION/ DESCRIPTION/ DESCRIPCIÓN		QUANTITY/ QUANTITÉ/ CANTIDAD
1	KING SHUTTER PANEL BED HEADBOARD		1PC
2L	Left Leg / Patte gauche / Pierna izquierda		1PC
2R	Right Leg / Patte droite / Pierna derecha		1PC
3	Bottom Rail / Rail inférieur / Riel inferior		1PC
4	Mending plate / Plaque de réparation / Placa de reparación		2PCS
5	KING SHUTTER PANEL BED FOOTBOARD		1PC
6	CAL. KING SHUTTER PANEL BED RAILS		2PCS



NOTE:
ASSEMBLE UNIT ON A SOFT SURFACE.
ASSEMBLEZ L'UNITÉ SUR UNE SURFACE MOLLE.
ENSAMBLE LA UNIDAD EN UNA SUPERFICIE PLANA Y SUAVE.

DO NOT TIGHTEN BOLTS UNTIL THE UNIT IS COMPLETELY ASSEMBLED.
NE SERREZ PAS LES BOULONS JUSQU'À CE QUE L'UNITÉ SOIT COMPLÈTEMENT ASSEMBLÉE.
NO APRIETE LOS TORNILLOS HASTA QUE LA UNIDAD ESTE COMPLETAMENTE ENSAMBLADA.

ASSEMBLY INSTRUCTIONS INSTRUCTIONS DE MONTAGE INSTRUCCIONES DE MONTAJE

KING SHUTTER PANEL BED HB
KING SHUTTER PANEL BED FB
CAL. KING SHUTTER PANEL BED RS

LIST OF PARTS AND HARDWARE/ LISTE DES PIÈCES ET DU MATÉRIEL/ LISTA DE PIEZAS Y HARDWARE

NO#/ NOMBRE/ NÚMERO	DESCRIPTION/ DESCRIPTION/ DESCRIPCIÓN		QUANTITY/ QUANTITÉ/ CANTIDAD
7	Slat / Latte / Listón	 1952x76x18mm	4PCS
8	Slat Support / Support de lattes / soporte de lamas	 221x34x34mm	12PCS

Note:

