

INSTRUCTIONS

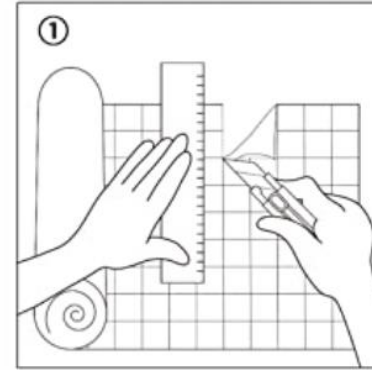

Get rid of foreign substances or dust from the surface, measuring and cutting

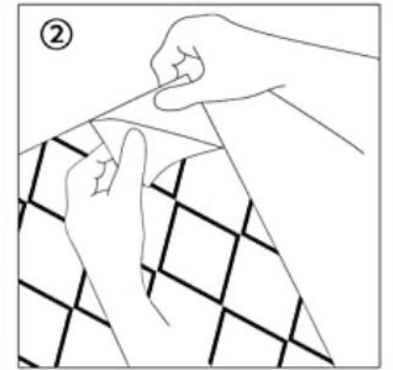

Peel off the backing paper and paste it onto the wall

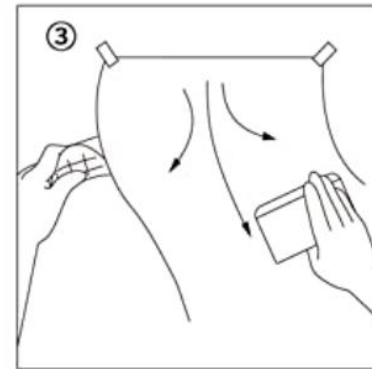

Paste while tearing off the lining paper

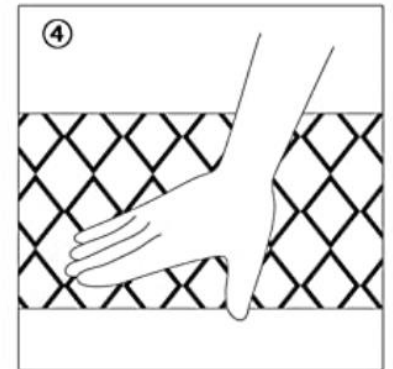

Use a needle or knife point to remove air bubbles

Pattern Information



Straight Match

Instruction For Use:

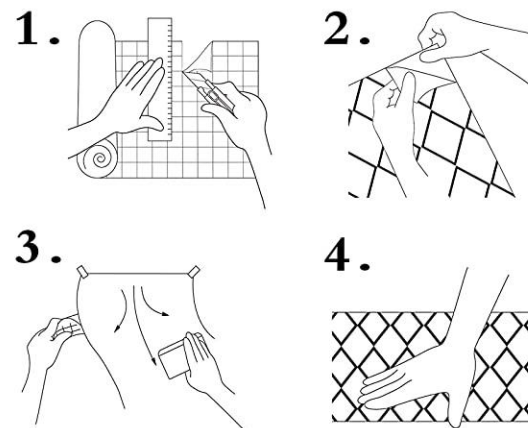
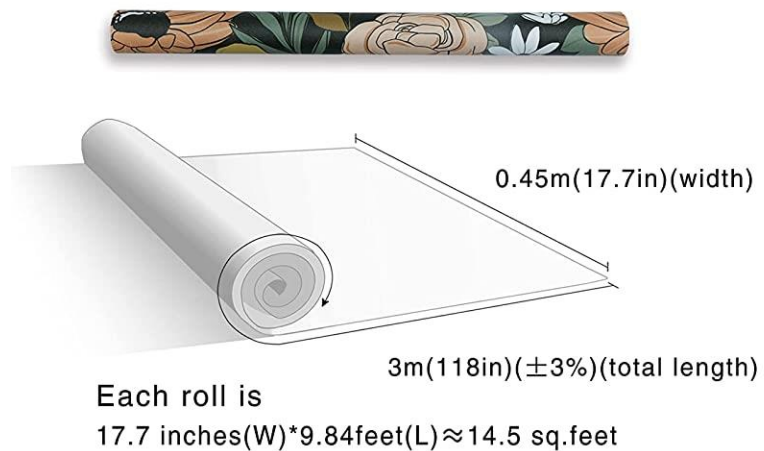

Waterproof

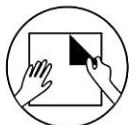

Removable



Easy Installation



Easy DIY



Safty