

READ AND SAVE THESE INSTRUCTIONS

INSTALLATION INSTRUCTIONS

Weight of Fan: 4.7 Kgs

1. TOOLS AND MATERIALS REQUIRED

- Philips screw driver
- Blade screw driver
- Step ladder
- Wire cutters

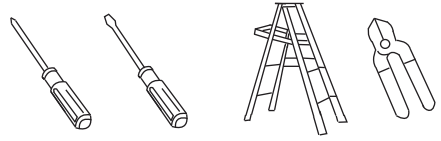

2. PACKAGE CONTENTS

Unpack your fan and check the contents. You should have the following items:

- a. Blade set (3)
 - b. Hanger bracket
 - c. Canopy
 - d. Canopy cover
 - e. Downrod assembly
 - f. Coupling cover
 - g. Fan motor assembly
 - h. LED light kit
 - i. Transmitter assembly
 - j. Receiver
 - k. Package hardware
- Mounting hardware:
- 2 Wood screws
 - 2 Lock washers
 - 2 Washers
 - 1 Blade screw (extra)

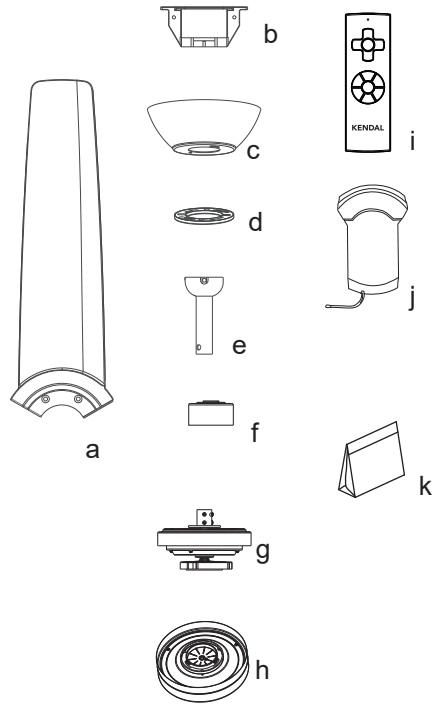

3. SAFETY RULES

1. To reduce the risk of electric shock, insure electricity has been turned off at the circuit breaker or fuse box before beginning.
2. All wiring must be in accordance with the National Electrical Code and local electrical codes. Electrical installation should be performed by a qualified licensed electrician.
3. **WARNING:** To reduce the risk of shock, this fan must be installed with an isolating wall control/switch.
4. **WARNING:** To reduce the risk of fire, electric shock, or other personal injury, mount fan only on an outlet box or supporting system marked acceptable for fan support of 35 lbs (15.9 kg) or less and use mounting screws provided with the outlet box. Most outlet boxes commonly used for the support of lighting fixtures are not acceptable for fan support and may need to be replaced. Consult a qualified electrician if in doubt.
5. The outlet box and support structure must be securely mounted and capable of reliably supporting a minimum of 50 pounds. Use only CUL Listed outlet boxes marked **"FOR FAN SUPPORT"**.
6. The fan must be mounted with a minimum of 7 feet clearance from the trailing edge of the blades to the floor.
7. For fans with manual reverse, do not operate reversing switch while fan blades are in motion. Fan must be turned off and blades stopped before reversing blade direction.
8. Avoid placing objects in the path of the blades.
9. To avoid personal injury or damage to the fan and other items, be cautious when working around or cleaning the fan.
10. Do not use water or detergents when cleaning the fan or fan blades. A dry dust cloth or lightly dampened cloth will be suitable for most cleaning.
11. After marking electrical connections, spliced conductors should be turned upward and pushed carefully up into outlet box. The wires should be spread apart with the grounded conductor and the equipment-grounding conductor on one side of the outlet box.
12. Electrical diagrams are reference only. Light kit that are not packed with the fan must be CUL Listed and marked suitable for use with the model fan you are installing. Switches must be CUL General Use Switches. Refer to the Instructions packaged with the light kits and switches for proper assembly.

WARNING
TO REDUCE THE RISK OF FIRE, ELECTRIC SHOCK OR PERSONAL INJURY, MOUNT FAN TO OUTLET BOX MARKED "ACCEPTABLE FOR FAN SUPPORT".

WARNING
TO REDUCE THE RISK OF PERSONAL INJURY, DO NOT BEND THE BLADE BRACKETS (ALSO REFERRED TO AS FLANGES) DURING ASSEMBLY OR AFTER INSTALLATION. DO NOT INSERT OBJECTS IN THE PATH OF THE BLADES.

4. MOUNTING OPTIONS

If there isn't an existing CUL listed mounting box, then read the following instructions. Disconnect the power by removing fuses or turning off circuit breakers.

Secure the outlet box directly to the building structure. Use appropriate fasteners and building materials. The outlet box and its support must be able to fully support the moving weight of the fan (at least 50 lbs). Do not use plastic outlet boxes.

Figures 1, 2 and 3 are examples of different ways to mount the outlet box.

Note: You may need a longer downrod to maintain proper blade clearance when installing on a steep, sloped ceiling. (Fig. 3)

To hang your fan where there is an existing fixture but no ceiling joist, you may need an installation hanger bar as shown in Figure 4.

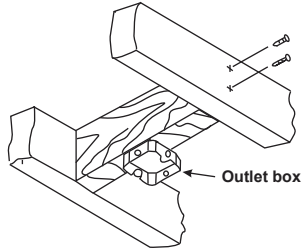

Figure 1

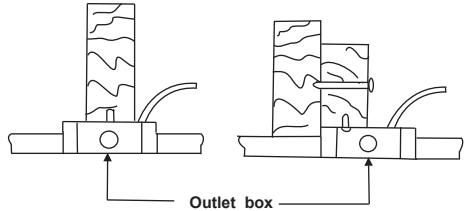

Figure 2

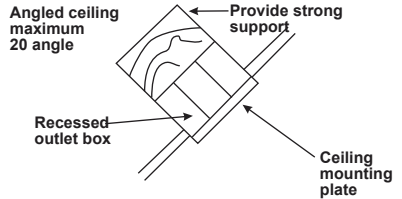

Figure 3

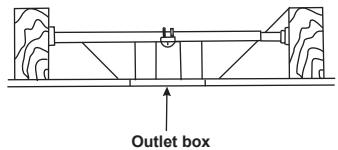

Figure 4

5. HANGING THE FAN

REMEMBER to turn off the power. Follow the steps below to hang your fan properly:

Step 1. Pass the 120-volt supply wires through the center hole in the ceiling hanger bracket as shown in Fig. 5.

Step 2. Secure the hanger bracket to the ceiling outlet box with the screws and washers provided.

Step 3. Remove the hanger pin, locking pin from the downrod assembly, and remove the set screws from the top of the motor. (Fig. 6)

Step 4. Route wires exiting from the top of the fan motor through the coupling cover, canopy cover and canopy, then through the ball/downrod. (Fig. 6)

Step 5. Align the holes at the bottom of the downrod with the holes in the collar on top of the motor housing (Fig. 6). Carefully insert the hanger pin through the holes in the collar and downrod. Be careful not to jam the pin against the wiring inside the downrod. Insert the locking pin through the hole near the end of the hanger pin until it snaps into its locked position, as noted in the circle inset of Fig. 6.

Step 6. Tighten two set screws against the downrod on top of the fan motor firmly. (Fig. 6)

Step 7. Place the downrod ball into the hanger bracket socket. (Fig. 7) And rotate fan and downrod assembly until tab on bracket lines up with slot on ball.

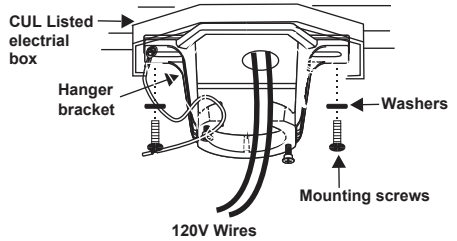

Figure 5

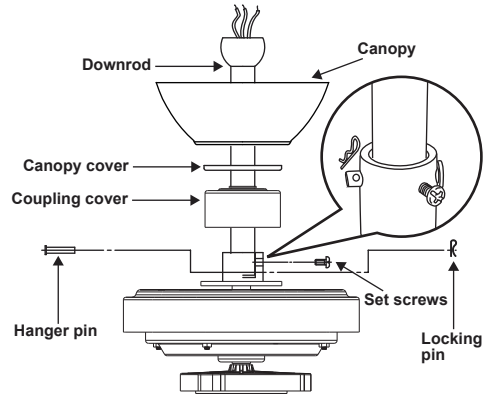

Figure 6

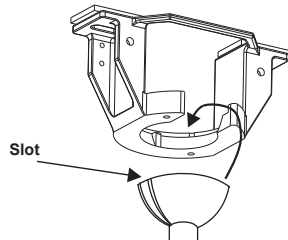

Figure 7

6. MAKE THE ELECTRIC CONNECTIONS

WARNING: To avoid possible electrical shock, be sure electricity is turned off at the main fuse box before wiring.

Step 1. (Fig. 8) Insert the receiver into the hanger bracket with the flat side of the receiver facing the ceiling.

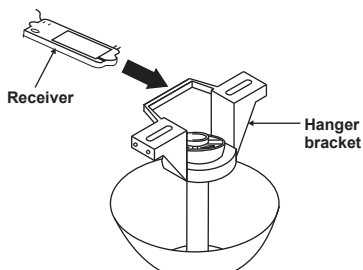

Figure 8

Step 2. (Fig. 9) Motor to Receiver Electrical Connections: Connect the Red wire from the fan to Red wire from the receiver. Connect the Yellow wire from the fan to the Yellow wire from the receiver. Connect the Gray wire from the fan to the Gray wire from the receiver. Connect the Blue wire from the fan to the Blue wire marked "For Light" from the receiver. Connect the White wire from the fan to the White wire marked "For Light" from the receiver. Secure wire connections with the plastic wire nuts provided.

Step 3. (Fig. 9) Receiver to House Supply Wires Electrical Connections: Connect the Black (hot) wire from the ceiling to the black wire marked "AC in L" from the receiver. Connect the white (neutral) wire from the ceiling to the white wire marked "AC in N" from the Receiver. Secure the wire connections with the plastic wire nuts provided.

Step 4. (Figure 9) If your outlet box has a ground wire (green or bare copper) connect it to the fan ground wires and the receiver ground wire; otherwise connect the hanging bracket ground wire to the fan and the receiver ground wire. Secure the wire connection with a plastic nut provided. After connecting the wires, spread them apart so that the green and white wires are on one side of the outlet box and other wires are on the other side. Carefully tuck the wire connections up into the outlet box.

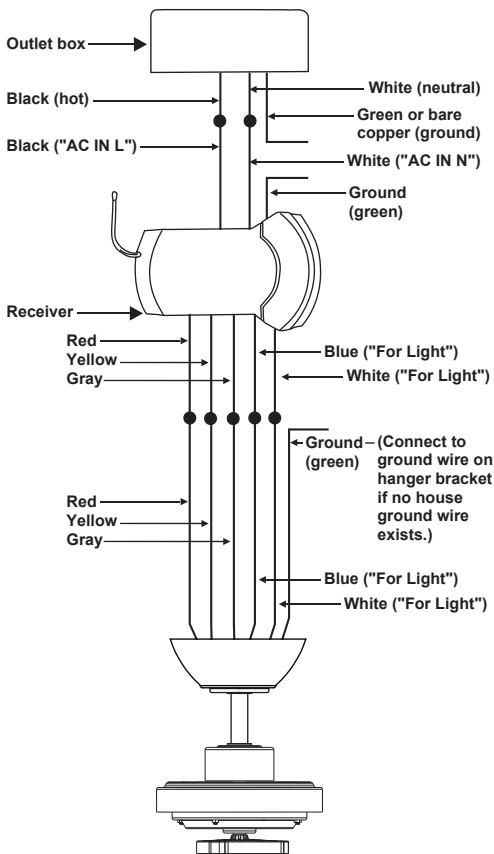

Figure 9

Note: Fan must be installed at a maximum distance of 20 feet from the transmitting unit for proper signal transmission between the transmitting unit and the fan's receiving unit.

7. INSTALLATION OF SAFETY SUPPORT

An additional safety cable is provided to prevent the fan from falling. Secure the safety cable to the ceiling joist with screw and washer, as illustrated in Figure 10.

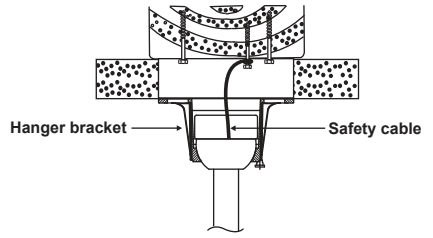

Figure 10

8. FINISHING THE INSTALLATION

Step 1. Tuck connections neatly into ceiling outlet box.

Step 2. Slide the canopy up to hanger bracket and place the key hole on the canopy over the screw on the hanger bracket, turn canopy until it locks in place at the narrow section of the key holes. (Fig.11)

Step 3. Align the circular hole on canopy with the remaining hole on the hanger bracket, secure by tightening the two screws.

Note: Adjust the canopy screws as necessary until the canopy and canopy cover are snug.

WARNING: Make sure tab at bottom of hanger bracket is properly seated in groove of hanger ball before attaching canopy to bracket. Failure to properly seat tab in groove could cause damage to electrical wiring.

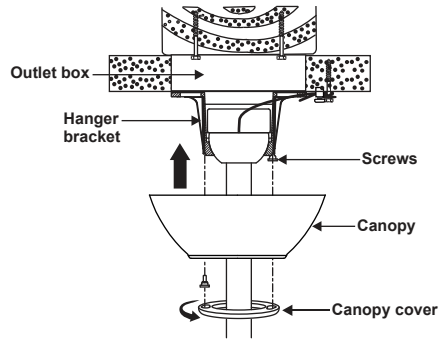

Figure 11

9. ATTACHING THE FAN BLADES

Step 1. Remove the six blade screws from the fan motor assembly. (Fig. 12)

Step 2. Attach the blade to the fan motor assembly using two blade screws. Attach the other blades to the fan motor assembly. (Fig. 13)

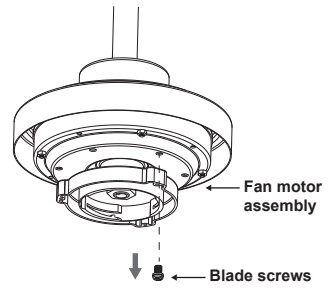

Figure 12

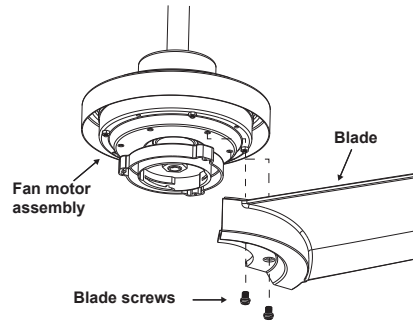

Figure 13

10. ATTACHING THE LED LIGHT KIT

NOTE: Before starting installation, disconnect the power by turning off the circuit breaker or removing the fuse at fuse box. Turning power off using the fan switch is not sufficient to prevent electric shock.

Step 1. While holding the LED light kit under your fan, firmly snap the wire connection plugs together.

Step 2. Attach the LED light kit to the switch box by twisting left tightly.

Note: This is an integrated LED light kit assembly and should not be disassembled to prevent electric shock.

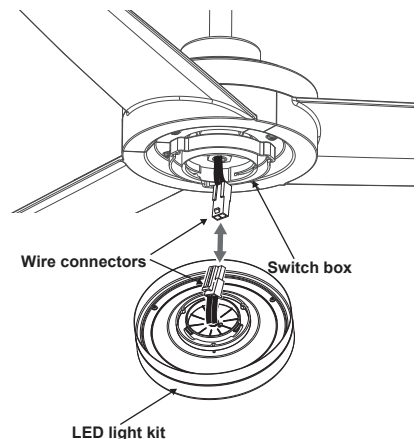



Figure 14

11. INSTALLING THE BATTERY

Remove the back cover on the transmitter and install a 12V battery included with the remote control. (Fig. 15)

12. LEARNING PROCESS

NOTE: After turning the AC power back on, do not press any other button on the remote control before pressing the  button. Doing so will cause the learning procedure to fail and the power to the fan will have to be turned off again to start over.

Turn main power to fan back on and within 30 seconds press and hold the  button on the remote for 5 seconds to sync the transmitter to the fan.

Once the fan has detected the remote, the light on the fan will blink twice to indicate your fan is now ready to use.

Fans without light-kits have no indicator but will be ready to use after holding the button for the 5 seconds.

12a. ADDING EXTRA REMOTE (OPTIONAL)

Turn main power to the fan off and repeat learning process above using the new remote.

13. INSTALLING THE TRANSMITTER HOLDER

Attach the remote control holder with the two remote control holder mounting screws. (Fig.17)

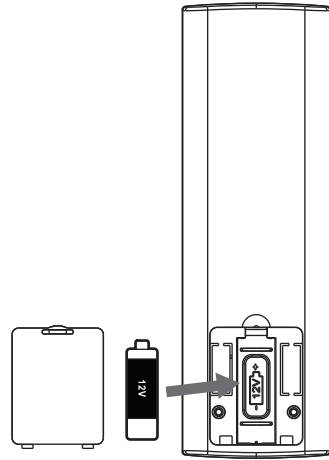

Figure 15

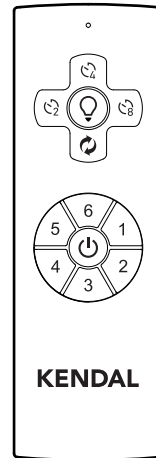

Figure 16

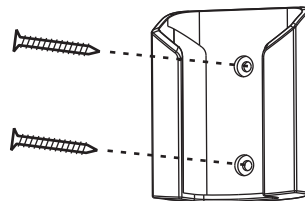

Figure 17

14. OPERATING YOUR TRANSMITTER

Restore power to ceiling fan and test for proper operation.

A. 1,2,3,4,5,6 buttons:

These six buttons are used to set the fan speed as follows:

- 1 = low speed 2 = medium low speed
- 3 = medium speed 4 = medium high speed
- 5 = high speed 6 = Extra high speed



B.  button:

This button turns the fan off. Hitting any speed button turns fan on.

C.  button:

This button controls the light. Press and release the button to turn the light ON or OFF. Press and hold the button to set the desired brightness. The light key has an auto-resume, it will stay at the same brightness as the last time it was turned off.

D.  button:

Pressing the ( /  / ) button will automatically turn fan off after 2, 4 or 8 hours.

E.  button:

Fan reverse button

NOTE: To operate the reverse function on this fan, press the reverse button while the fan is running at any speed.

Speed settings for warm or cool weather depend on factors such as the room size. Ceiling height, number of fans and so on.

Warm weather - (Forward) A downward airflow creates a cooling effect as shown in Fig. 18. This allows you to set your air conditioner on a warmer setting without affecting your comfort.

Cool weather - (Reverse) An upward airflow moves warm air off the ceiling area as shown in Fig. 19. This allows you to set your heating unit on a cooler setting without affecting your comfort.

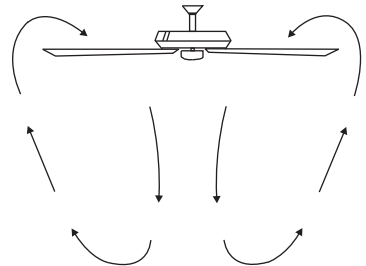

Figure 18

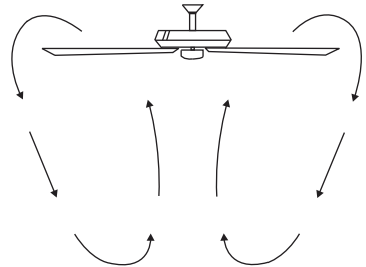

Figure 19

15. CARE OF YOUR FAN

Here are some suggestions to help maintain your fan.

1. Because of the fan's natural movement some connections may become loose. Check the support connections, brackets and blade attachments twice a year. Make sure they are secure. (It is not necessary to remove fan from the ceiling).
2. Clean your fan periodically to help maintain its new appearance over the years. Use only a soft brush or lint free cloth to avoid scratching the finish. Plated finishes are sealed with lacquer to minimize discoloration or tarnishing. Do not use water when cleaning, this could damage the motor, wood blades or possibly cause an electrical shock.
3. If your fan is provided with wood veneer blades; you can apply a light coat of furniture polish for additional protection and enhanced beauty. Cover small scratches with a light application of shoe polish.
4. Use a lint free lightly damp cloth or duster to remove dust from the blades.
5. There is no need to oil your fan. The motor has permanently lubricated bearings.
6. If your fan is provided with glass shades, clean with lukewarm soapy water and a soft cloth or sponge.

DO NOT IMMERSE GLASS SHADES IN HOT WATER. DO NOT PUT GLASS SHADES INTO AN AUTOMATIC DISHWASHER.

WARNING: Make sure the power is off at the electrical panel box before you attempt any repairs. Refer to the section, "Making Electrical Connections".

16. TROUBLESHOOTING

Problem

Solution

Fan will not start.

1. Check circuit fuses or breakers.
2. Check line wire connections to the fan and switch wire connections in the switch housing. **CAUTION:** Make sure main power is off.

Fan sounds noisy.

1. Make sure all motor housing screws are snug.
2. Make sure the screws that attach the fan blade bracket to the motor hub is tight.
3. Make sure wire nut connections are not rubbing against each other or the interior wall of the switch housing. **CAUTION:** Make sure main power is off.
4. Allow a 24-hour "breaking-in" period. Most noise associated with a new fan disappear during this time.
5. If using an optional light kit, make sure the screws securing the glassware are tight. Check that light bulb is also secure.
6. Do not connect the fan with wall mounted variable speed control(s).
7. Make sure the upper canopy is a short distance from the ceiling. It should not touch the ceiling.

Remote control malfunction.

1. Do not connect the fan with wall mounted variable speed control(s).
2. Re-do learning process.

Fan wobble.

1. Check that all blade and blade arm screws are secure.
2. Most fan wobbling problems are caused when blade levels are unequal. Check this level by selecting a point on the ceiling above the tip of one of the blades. Measure this distance. Rotate the fan until the next blade is positioned for measurement. Repeat for each blade. The distance deviation should be equal within 1/8".
3. If the blade wobble is still noticeable, interchanging two adjacent (side by side) blades can redistribute the weight and possibly result in smoother operation.

WARNING: TO REDUCE THE RISK OF PERSONAL INJURY, DO NOT BEND THE BLADE ARM WHILE INSTALLING, BALANCING THE BLADES, OR CLEANING THE FAN. DO NOT INSERT FOREIGN OBJECTS BETWEEN ROTATING FAN BLADES.