



## **Maxxus Infrared Sauna Instruction Manual**

Models: MX-J206-01/MX-J306-01  
2 and 3 Person FAR Infrared Saunas



CARBON MODEL SAUNA  
FOR INDOOR USE ONLY

MX-J206-01:120VAC 15AMP Dedicated Circuit Required

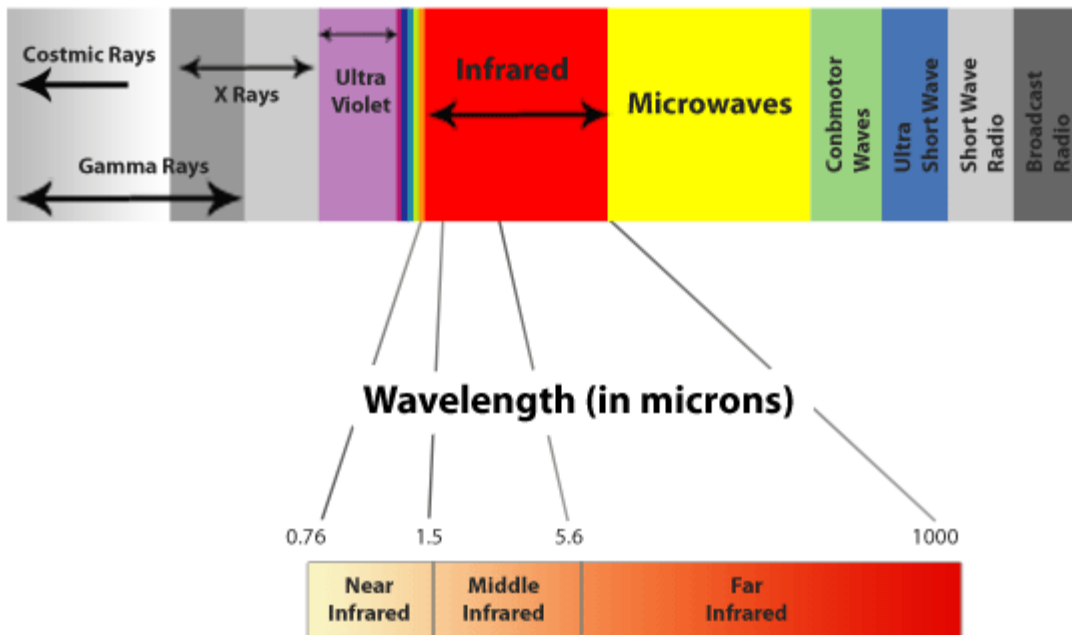
MX-J306-01: 120VAC 20AMP Dedicated Circuit Required

Carefully and thoroughly read this Owner's Manual before using/operating the sauna. We recommend keeping this Owner's Manual for regular review and future reference.

## What Are Infrared Rays?

Infrared is the band of light we perceive as heat. We cannot see this band of light with the naked eye, but we can feel this type of light in the form of heat. Our sun produces most of its energy output in the infrared segment of the spectrum. Infrared rays heat your body without having to heat the air in-between. This process is called conversion.

The infrared is divided into 3 segments by wavelengths measured in microns: Near Infrared – 0.76-1.5 microns; Middle Infrared – 1.5-5.6 microns; and Far Infrared – 5.6-1000 microns. Among these segments, Far Infrared penetrates organic substances such as the human body two to three inches so that the warming effect is very uniform.



## Health Benefits

Because infrared rays penetrate the body through conversion, there is a deep heating effect in both the muscle tissues and internal organs without putting too much burden on the heart.

Our body reacts to the increased heating through the natural cooling process of perspiring. Through the perspiration process, acid and waste residue like toxins, sodium, alcohol, nicotine, cholesterol, and the potentially carcinogenic heavy metals are removed from the cells (especially zinc, lead, nickel, cadmium, etc.). The pores of our skin open and discharge waste products shedding any old skin cells leaving the skin glowing and clean, with improved tone, elasticity, texture, and color.

## **Health Benefits Include, But Are Not Limited To:**

- \*Pain relief from Rheumatoid Arthritis
- \*Relaxes muscle spasms
- \*Increases blood circulation
- \*Cardiovascular conditioning
- \*Clears rashes, acne
- \*Reduces cellulite
- \*Removes toxins and mineral waste
- \*Reduces stress and fatigue
- \*Enhances skin tone

## **DISCLAIMER**

The infrared rays emitted by your sauna are reported to offer a wide range of possible therapeutic benefits based on research completed over the last 40 years from all around the world. These benefits are presented for reference purposes only and no implication of infrared saunas creating a cure for or treating any disease is implied nor should it be inferred. If you have a medical/health condition, are taking prescription drugs, or have acute joint injuries, please consult with your medical physician before using the sauna. Persons with surgical implants (metal pins/rods, artificial joints, silicone, or other types of surgical implants) typically do not experience any adverse effects, but should also consult their medical physician or surgeon before using the sauna room.

## **What are electric and magnetic fields?**

Electric and magnetic fields are a basic force of nature (like gravity), generated by electricity. They are found almost everywhere. Electric and magnetic fields are found in nature, where they are created by such things as lightning and static electricity. Manmade fields are found wherever people use electricity, such as near powerlines and electrical appliances. Like sound, electric and magnetic fields are made of a mixture of components and so can be described in many different ways. Both have wave-like properties such as strength and “frequency” (how often they cycle back and forth). Sound can be loud (strong) or soft (weak), high or low pitched (different frequencies), suddenly loud or constant in tone, and pure or jarring. Similarly, electric and magnetic fields are a mixture of components. They can be strong or weak, have a high or low frequency, have sudden increases in strength (“transients”) or a constant strength, and consist of one pure frequency or several (called “harmonics”). For example, the *strength* of a field can be weak and constant, as in most nighttime home environments, or it can be strong and vary from high to low every few seconds, as from an electric blanket set on high. Powerlines and wiring in buildings and appliances generate 50 and 60 Hertz fields, sometimes referred to

as “power frequency” fields. Hertz is the unit for measuring the frequency of fields in the number of wave cycles each second. The lower the frequency of a field, the lower its energy. Power frequency fields are low frequency fields and have low energy levels. Microwave and x-ray fields are high frequency fields and have high energy levels. Below are some EMF measurements.

### EMF Levels from Common Homes Sources

SOURCE	mG up to 4 inches	mG at 3 feet
Blender	50-220	0.3-3
Clothes Washer	8-200	0.1-4
Coffee Maker	6-29	0.1
Computer	4-20	2-5
Flourescent Lamp	400-4,000	0.1-5
Hair Dryer	60-20,000	0.1-6
Microwave Oven	100-500	1-25
Television	5-100	0.1-6
Vacuum Cleaner	230-1,300	3-40
Airplane	50	

Source: USA Environmental Protection Agency

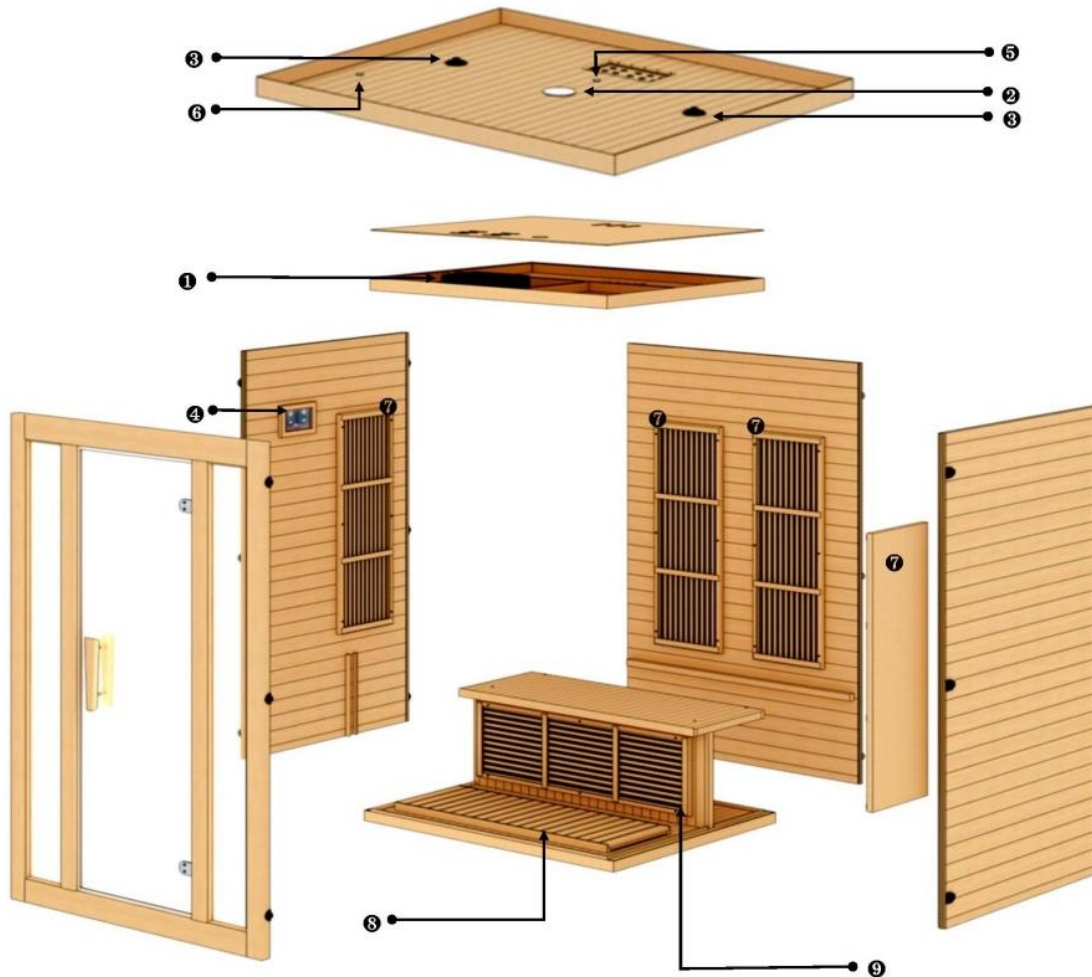
After many years and numerous studies on EMF exposure, no government body including the Occupational Safety and Health Administration (OSHA) have established permissible exposure limits (PEL). Currently, there is no consensus on the potential health hazard from any exposure to EMF. The mainstream scientific evidence suggests that low-power, low-frequency, electromagnetic radiation associated with household currents like that of the infrared sauna does not constitute a short or long term health hazard.

### Sauna Maintenance

Since infrared saunas do not require hot rocks, water, or steam to operate, they require very little maintenance. You can simply wipe it down with water – use a damp, soft, and clean cloth. **Do not use any chemical based cleaning agents** as they can be absorbed into the wood and be released into your sauna during use.

**\*PLEASE READ INSTRUCTIONS THOROUGHLY BEFORE ASSEMBLY\***

**MX-J206-01**



Electronic components			
No.	Name	No.	Name
1	power supply	2	LED lamp
3	Speaker	4	Control panel
5	Temperature sensor	6	AUX MP3

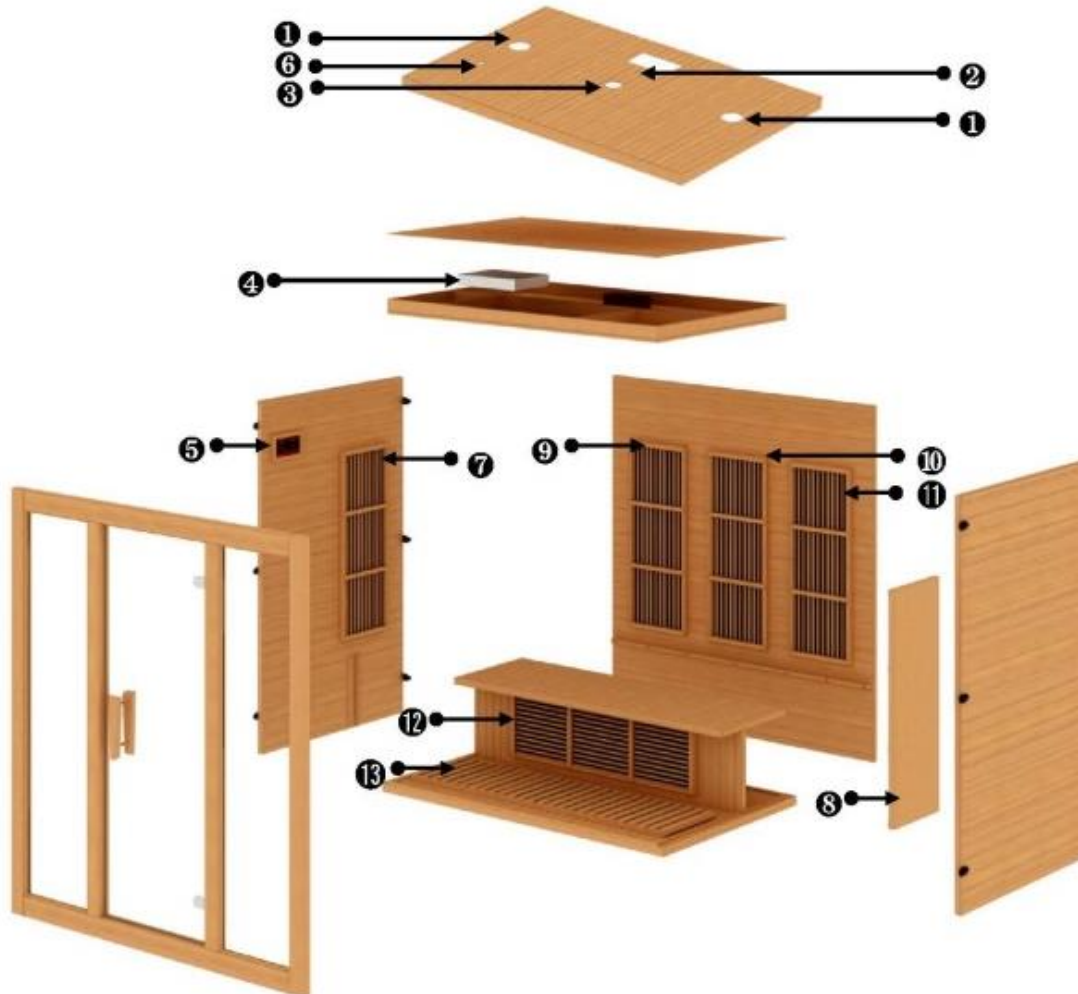
Power layout			
Location	No.	Dimension	Power
Left wall panel	7	1000*300mm=4PCS	300W
Right wall panel			
Rear wall panel			
Floor heater	8	1000*340mm=1PCS	300W
Heater bench	9	1000*300mm=1PCS	200W
Total			1700W

**\*THE ABOVE ASSEMBLY DIAGRAM IS FOR A QUICK REFERENCE VISUAL GUIDE ONLY. ALL SAUNA MODELS MAY NOT BE SHOWN. PARTS AND ACCESSORIES DO VARY AND ARE SUBJECT TO CHANGE.**



**\*PLEASE READ INSTRUCTIONS THOROUGHLY BEFORE ASSEMBLY\***

**MX-J306-01**



Electronic components			
No.	Name	No.	Name
1	Speakers	2	Sensor
3	Interior reading lamp	4	Power supply
5	Control panel with BT	6	MP3 Jack

Power layout			
Location	No.	Dimension	Power
Left panel	7	1000*300mm=6PCS	300W
Right panel	8		
	9		
Back panel	10	1000*340mm=1pcs	300W
	11		
Bench heater panel	12		
Floor panel	13		
TOTAL			2100W

**\*THE ABOVE ASSEMBLY DIAGRAM IS FOR A QUICK REFERENCE VISUAL GUIDE ONLY. ALL SAUNA MODELS MAY NOT BE SHOWN. PARTS AND ACCESSORIES DO VARY AND ARE SUBJECT TO CHANGE.**

## TABLE OF CONTENTS

Packing List	6
Highlights	7
Assembly	8
Operating the Sauna	14
Tips for Using your Sauna	17
Safety Instructions	17
Safeguards for your Sauna	19
Troubleshooting Guide	20
Warranty	22
Warranty Card	24

**WARNING: Visually inspect all heaters before assembly to make sure they are not damaged. Any excessive vibrations during transport could cause damage to the heating elements. DO NOT START the sauna if damage is detected! Contact your dealer or manufacturer for troubleshooting and replacement parts.**

### Packing List (main panels)

1pc Front Panel	1pc Back Panel	1pc Right Side Panel
1pc Left Side Panel	1pc Floor Panel	1pc Roof Panel
1pc Roof Cover	1pc Bench	1pc Bench Heat Emitter Panel

**NOTE: Your model sauna has been completely assembled and tested prior to packaging. The rear wall panel is intentional warped as part of the overall design. Two adults will be needed to assemble the sauna room.**

**CAUTION: Exit Sauna Immediately If You Feel Dizzy, Sleepy, Or Any Discomfort.**

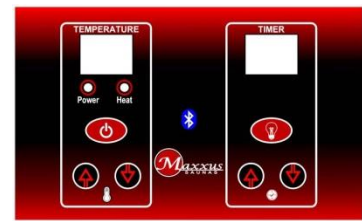
# Highlights

- A. High quality craftsmanship
- B. Temperature control
- C. Timer
- D. Infrared carbon heat emitter panels
- E. Control Panel:

MX-J206-01



MX-J306-01



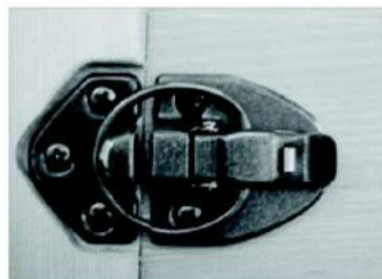
- F. Power supply:



- G. MP3 Jack:



- H. Buckles:





## Assembly

Please note the following:

- A. You will need a Philips screwdriver, ladder, and two adults to assemble.
- B. Do not plug any other appliances into the power supply of the sauna room other than the designated sauna connections/plugs.
- C. Assemble the sauna room on a completely level surface.
- D. Do not spray or get water on the exterior/interior walls of the sauna room. If the floor which the sauna will sit on is damp or wet, install a barrier between your floor and the sauna floor to keep the sauna's floor from becoming damp or wet.
- E. Do not store flammable objects or chemical substances near the sauna.
- F. 1-person and 2-person saunas are packed into two cartons. For example - C/NO: 002 1 OF 2 and C/NO: 002 2 OF 2. 3-person sauna and 4-person saunas are packed in three cartons. For example - C/NO: 002 1 OF 3, C/NO: 002 2 OF 3, and C/NO: 002 3 OF 3. (see FIG-2.1 & 2.2)

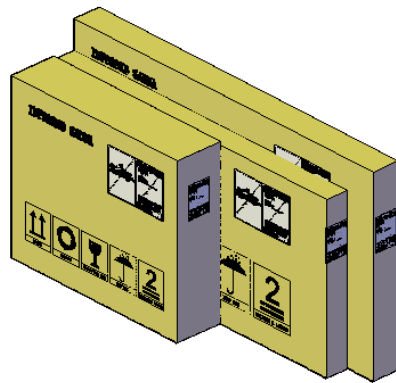


FIG-2.1 Cartons

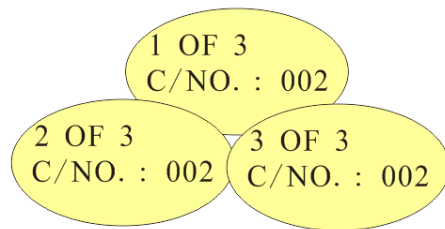


FIG-2.2 C/No.

1. Place the Floor Panel on a smooth/flat/level surface and make sure which side is the front and which side is the back. The front of the floor has **no** quarter round trim molding as do the other three sides. (see FIG 3)

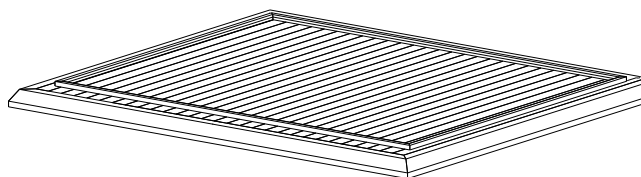
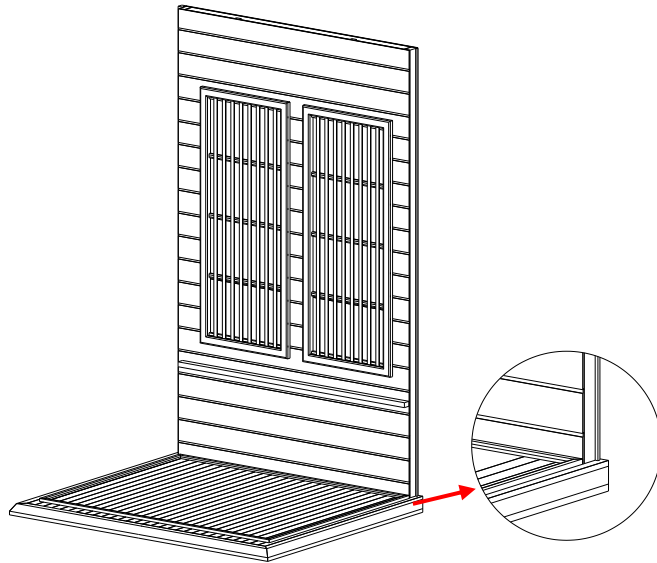


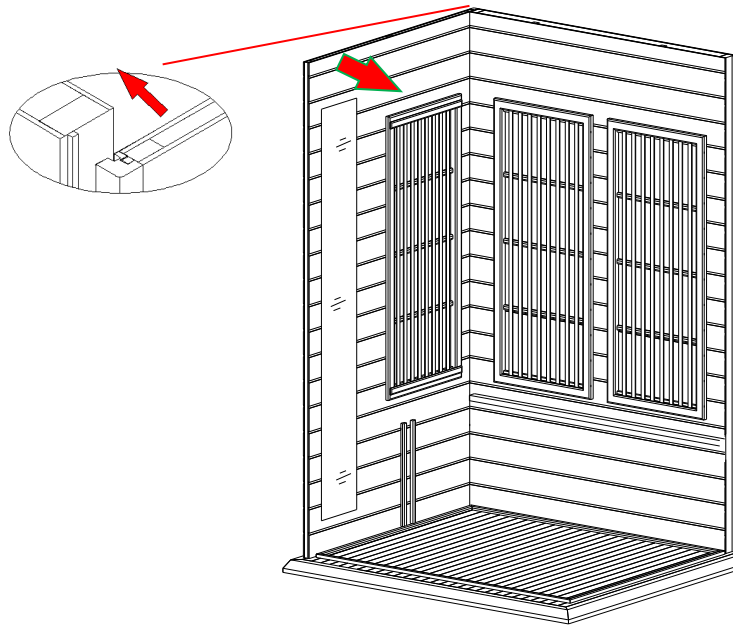
FIG 3 Placing Floor Panel

2. Align the Back Panel with the Floor Panel's corresponding wood pattern; make sure the wood pattern is flowing in the same direction. One person should hold the Back Panel while the other person continues to the next step. (see FIG 4)



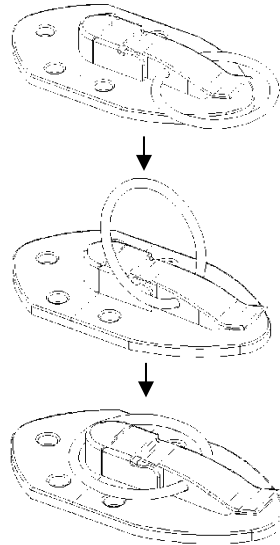
**FIG 4 Assembling Back Panel**

3. Align the Left Side Panel with the Floor Panel's corresponding wood pattern. Make sure the Left Side Panel fits flush into the Back Panel. (see FIG 5)



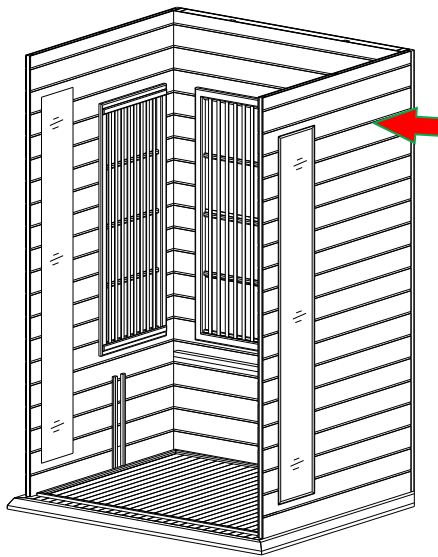
**FIG 5 Assembling Left Side Panel**

4. For all other models, latch the Left Side Panel with the Back Panel. The buckle has a guide tab that must be placed in the guide slot for alignment. When the Back Panel and the Side Panel is attached together on the floor panel, make sure all the buckles are latched. (see **Figure 6**)

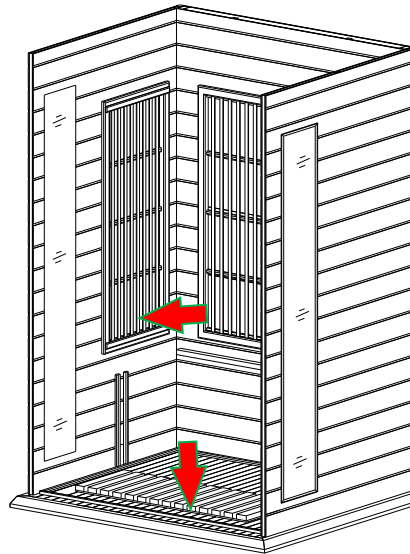


**FIG 6 Buckle**

5. Align the Right Side Panel with the Floor Panel's corresponding patterns. Make sure the Right Panel fits flush into the Back Panel and latch together. (see **FIG 7** and **FIG 8**)



**FIG 7 Assembling Right Panel**



**FIG 8 Placing Floor Heater**

6. Place the Floor Heater on the Floor Panel making sure that the Floor Heater is in front of the Bench Heat Emitter Panel. Please note there is a pre-cut small hole under the Bench Heat Emitter Panel which is provided for the Floor Heater cord. This cord will connect the Floor Heater to the plug outlet on the Left Side Panel. (see FIG 8 and 8.1)

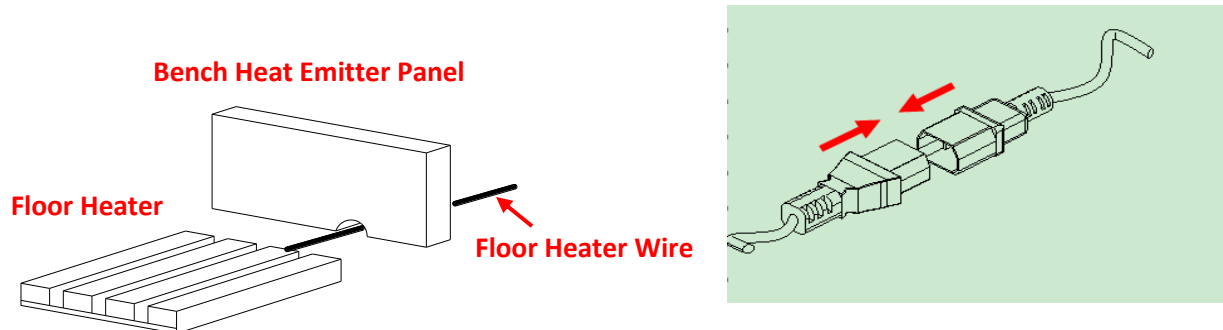


FIG 8.1 Connect Floor Heater

7. Make sure to slide the Bench Heat Emitter Panel all the way down (vertically) into the slot provided on both the Left and Right Side Panels. Connect the Bench Heat Emitter Panel cord with the outlet on the Back Panel and then place the Bench on top of the Bench Heat Emitter Panel and slide it into place. (see FIG 9 and 10) **Please Note: Make sure the cords are connected snug and tight.**

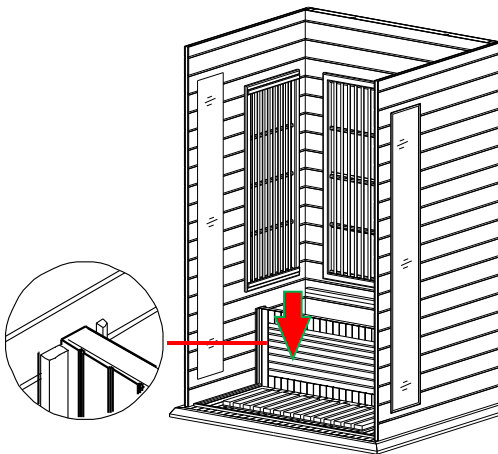


FIG 9 Connecting Cord

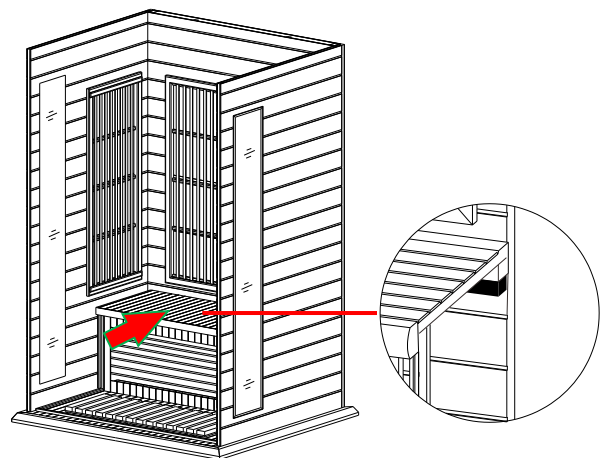
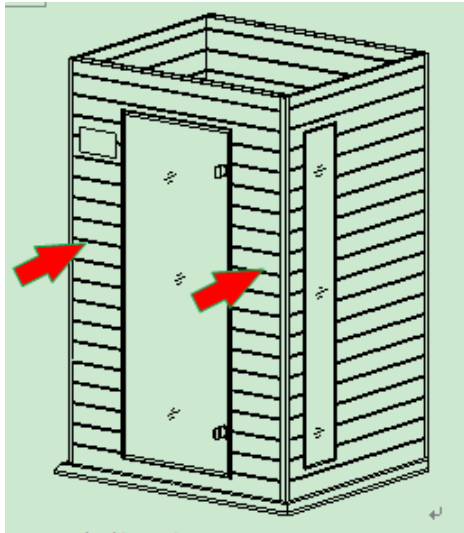


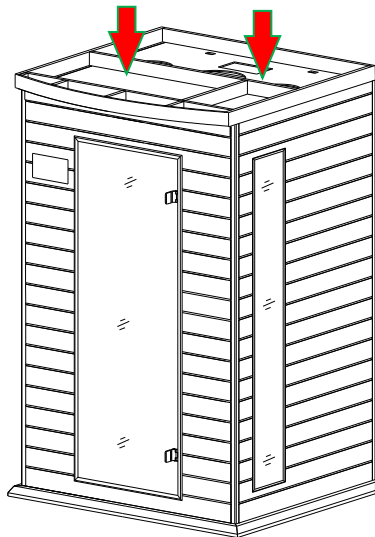
FIG 10 Installing Bench

8. Align the Front Panel with the Floor Panel's corresponding patterns. Make sure the wood pattern is flowing in the same direction. Next, latch the Front Panel with the Left and Right Side Panels respectively. Note: Be cautious with the glass door to avoid breakage. See FIG 11.

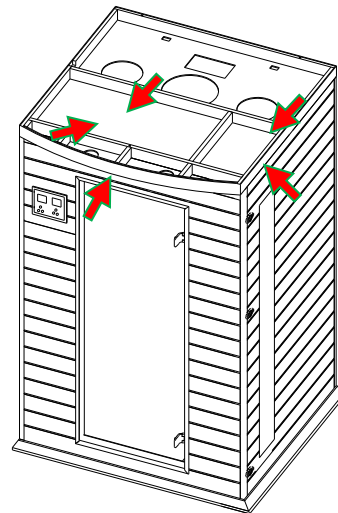


**FIG 11 Assembling Front Panel**

9. Place cords/wires of Front Panel and Back Panel into the sauna room area to avoid damaging the cords/wires during the roof installation. Open the door, lift the Roof Panel up and over the sauna room, and gently lower it into place resting it on the wall panels. (see FIG 12) Make sure that all cords/wires are slipped through the corresponding holes in the Roof Panel. Proceed in screwing the Roof Panel down. (see FIG 13)

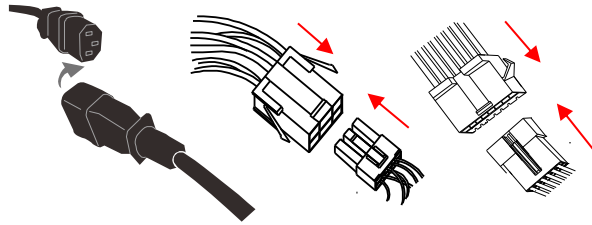


**FIG 12 Installing Roof Cover**



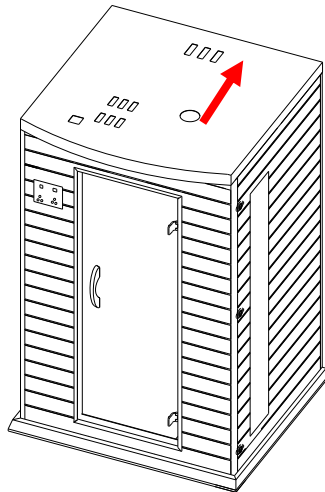
**FIG 13 Slip cords/wires through corresponding holes**

10. Connect all the wires and connectors to the corresponding outlets on the Roof Panel. Be sure all the plugs are connected snug and tight. (see FIG-14)



**FIG-14 Connecting cords/wires connectors**

11. Make sure all steps are completed correctly. Next, plug in the power cord to your wall outlet. Turn on the sauna at the control panel to confirm that the control panel is responding. If the control panel responds accordingly, then proceed in putting the Roof Cover onto the Roof Panel. Make sure to pull the power cord through the corresponding hole in the Roof Cover. Proceed in screwing down the Roof Cover to the Roof Panel. (see FIG 19)



**FIG 19 Slip the power cord through Roof Cover**

12. Attach the door handle and screw into place. If your unit came with any accessories such as the cup holder or magazine rack, you can screw down to the interior wall panel.
13. Enter the sauna and remove the protective masking tape from the TEMPERATURE SENSOR. Situate the TEMPERATURE SENSOR so that it is vertical, pointing downward. (see FIG 20)





FIG 19 Temperature Sensor

**Installation Completed.**

## Operating the Sauna

**MX-J206-01**



**MX-J306-01**



### 1. Precautions

- A. Please make sure your wall outlet meets the specifications required. Failure to meet the requirements may cause safety risks.
- B. Set the temperature and time to a comfortable level. Please keep in mind that you can either preheat the sauna to the set temperature before entering or sit inside the sauna as the temperature rises. Please note that you will increase the time it takes for the sauna to reach the set temperature if you enter the sauna room before it has reached the set temperature. Also, the most commonly used temperature setting is between 118 degrees Fahrenheit / 48 degrees Celsius and 122




degrees Fahrenheit / 50 degrees Celsius. The way the sauna room works is when you set the Control Panel to say 120 degrees F / 49 degrees C, the heat emitters will turn off when that set temperature is reached. And even though the sauna does allow the user to set the Control Panel to 150 degrees F/65 degrees C, this is specifically for those users who do not want the heat emitters to ever turn off as the sauna room will most likely never achieve 150 degrees F / 65 degrees C (depending on your room ambient temperature). Please further not that if the ambient temperature is below 72°F, the sauna will take longer to pre-heat. It is not recommended to use the sauna in an environment with an ambient temperature below 60°F.


- C. Drink water prior to, during, and after your sauna session to replenish body fluids.
- D. After 3 hours of continuous use, the sauna needs to be shut down for one hour.
- E. To avoid burns, do not touch the heating element.

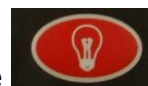
## 2. Operating The Sauna

- A. Review the electrical label on the sauna and then plug the sauna into the proper wall outlet. No other appliance can be operated on the same electrical breaker as the sauna when the sauna is in use. Proceed in turning on the sauna room using the ON/OFF button to activate the sauna.
- B. The sauna should be **unplugged** when not in use.





- C. **To set the temperature**, press the  temperature buttons to increase or decrease the temperature to the desired temperature. If the "Heat" light is on, the temperature setting will increase one degree every time the  button is pressed. If pressed for three seconds, the setting will increase quickly. Decrease the temperature in the same manner by pressing the  button. After the sauna reaches the desired temperature, the "Heat" light will turn off.

- D. Press the  button to turn the light ON. If you want to use the **Color Light Therapy System**:

- A. While the interior light is ON, press and hold down the  button for 2 seconds. You will notice "2n" in the LED display. This indicates you are in the "light" mode. If you do not press any buttons for approximately 15 seconds, the "2n" will change back to the Timer mode.

- B. While the "2n" is displayed, you can now turn the exterior light ON/OFF by pressing the  button in the  section of the control panel.

- C. You can also turn the interior light ON/OFF by pressing the  button in the  section of the control panel.

4. While the interior light is on and the “2n” is still displayed in the LED display,



you can press the button to scroll through the different colors within the Color Light Therapy System. You will notice that you have two selections for “white”:

- A. The first selection for “white” will allow the colors to go through a sequence of the different shades of colors.
- B. The second selection for “white” will continue to display the white light.



To return back to the Timer mode, press the button.

- E. You can operate the sauna with the ceiling vent in the open or closed position.
- F. After your sauna session is over, you can turn the control panel off by pressing the ON/OFF button. You can unplug the sauna cord if the sauna will not be used for an extended period of time.



- G. To set the time, press the buttons. Press ‘ and buttons to set the timer from 5 to 60 minutes. If pressed for three seconds, the timer will increase/decrease quickly. When the timer display shows “05”, the timer will buzz and the sauna will shut off automatically after 5 minutes. To extend the sauna



session, reset the timer again by pressing the



- H. The Fahrenheit and Centigrade display can be switched by pressing and holding

the temperature button and at the same time and then pressing the



- I. The Bluetooth function (MX-J306-01) is built into the Control Panel. For the Bluetooth function, you first will need to pair your device with the sauna room. Open your device’s Settings Menu and then locate and open Bluetooth. You will find **BT-AUDIO**. Now you can pair your device. Once pairing is successful, your device will be connected. You will control the volume and choose the music on your device.
- J. The MP3 Jack will allow you to connect your musical device using the AUX wire. Plug one end of the AUX wire into your musical device and the other end into the MP3 Jack at the ceiling. Do not leave the AUX wire connected at the ceiling when not using this function as it may cause static interference at the speakers. You will control the volume and choose the music on your device. When you disconnect the MP3 wire, the sound system will automatically return back to the Bluetooth mode.

**CAUTION: Exit sauna immediately if you feel dizzy, sleepy, or any discomfort.**

## Tips for using Your Sauna

1. If you take a hot/warm shower or bath before using your sauna, you may perspire more and experience more comfort.
2. Drink water prior to, during, and after your sauna session to replenish body fluids.
3. To regulate the set temperature inside the sauna to your comfort level, use the movable roof vent or leave the door slightly open. The roof vent is installed on the sauna and used based on personal preference.
4. Use 2 towels during your sauna session. Fold the first towel several times and place it on the bench. As you sit on this towel, it will absorb a majority of your perspiration while adding comfort as you sit on the bench. Use the second towel to constantly wipe the perspiration from your body to perspire faster and also to avoid having too much perspiration dripping onto the floor heater. If your legs become cold, you can use a third towel to drape over your legs to trap the heat.
5. At the first sign of a cold or flu, increasing your sauna sessions may be beneficial in boosting your immune system and decreasing the reproductive rate of the virus.
6. To help relieve sore and tense muscles, massage the affected areas during your sauna session.
7. To treat your ankles and feet more effectively, you can elevate them and move them close to one of the heat emitters to achieve a deep heating effect.
8. To utilize the sauna's heat therapy effect, put oil and treatment into your hair and wrap it with a towel. After your sauna session is over, rinse your hair thoroughly.
9. The peaceful and relaxed state rendered by a sauna session may help you to sleep easier and deeper.
10. To conserve energy consumption, please unplug your sauna when not in use – especially if you do not plan on using the sauna for an extended period of time.
11. After the sauna session is over, do not jump into the shower or bath immediately. Because your body was heated up during the sauna session, it will continue to perspire even after the heat emitters are off. Sit in the sauna with the door slightly opened and let your body cool down. Once your body has cooled down and you feel comfortable, you can exit the sauna. After about fifteen minutes and when your body has completely cooled down, you can take a shower or bath to clean your body.

## Safety Instructions

1. Read and follow all instructions carefully before using the sauna.
2. When assembling and using the electrical equipment, safety precautions should always be followed.
3. To reduce the risk of injury, do not allow children to use the sauna unless they are closely supervised at all times by an adult. Children should not use the sauna unless prescribed or advised by their medical doctor.
4. Do not use the sauna immediately following strenuous exercises. Wait at least 30 minutes to allow the body to cool down completely.

5. Pregnant or possibly pregnant women should contact their medical physician prior to using the sauna. Excessive temperatures have a high potential for causing fetal harm during pregnancy.
6. **Hyperthermia Danger:** The normal body temperature can't rise above 103°F (39°C). Symptoms of excessive hyperthermia include dizziness, lethargy, drowsiness, and/or fainting. The effects of excessive hyperthermia may include, but are not limited to failure to perceive heat, physical inability to exit the sauna, unawareness of impending hazards, unconsciousness, and/or fetal harm in pregnant women. Hyperthermia could make your body's core temperature rise. Setting the desired temperature to an excessively high temperature is not recommended.
7. The use of alcohol, drugs, or medications (prescribed or non-prescribed) prior to or during the sauna session may lead to unconsciousness and/or other harmful physical injuries.
8. Persons suffering from obesity or with a medical history of heart disease, low or high blood pressure, circulatory system problems, diabetes, or other medical conditions should consult with a medical physician prior to using the sauna.
9. Persons using medications should consult with a medical physician before using the sauna. Some medications may induce drowsiness while other may affect the heart rate, blood pressure, and/or blood circulation.
10. Use care when exercising before and after sauna use.
11. Never sleep inside the sauna
12. Do not use any type of cleaning agents on the interior of the sauna. Only wipe down the sauna room with water and a damp cloth. Never use any chemical based cleaners.
13. Do not stack or store any objects on top of or inside the sauna.
14. If the power supply cord becomes damaged, it must be replaced immediately by the manufacturer or its agent. If you find the power cord is too hot (normally it will become warm) or that the electrical equipment may be experiencing technical problems, please contact the manufacturer or its agent immediately to avoid hazardous situations.
15. Make sure that the electrical outlet is in good working order. A common problem with electrical outlets is loose wiring on the connection points of the terminals of the outlet. A loose wire will also make for a bad connection and cause an unusual amount of heat buildup. Loose connections can also cause sparking in the junction box that can result in arcing. You'll likely see burn marks around the terminals if this occurs. If this happens, do not use the sauna and have the outlet replaced by a certified electrician. If the power cord is damaged, please contact Customer Support.
16. Do not use the sauna during an electrical storm to avoid risk of shock or injury.
17. Do not continuously switch the power ON and OFF excessively as it will compromise the life of the electrical components.
18. Your hands must be dry and free of moisture before plugging and unplugging cords and wiring harnesses from the power supply and circuit boards. Never operate the sauna with wet hands or wet feet to avoid the risk of electrical shock or injury. Never touch the metal prongs of the plug.

19. Do not attempt to make any repairs yourself unless authorized by the manufacturer or its agent. If a problem occurs with the sauna, please contact the manufacturer or its agent immediately to avoid safety risks. Unauthorized repair attempts will void the manufacturer's warranty.
20. Please make sure the outlet power supply meets the specifications required. Failure to meet the requirements may cause safety risks.
21. Some sauna models are equipped with reading and/or roof lamps. Because the lamp temperature will become very hot once powered ON, do not attempt to touch the lamp to avoid being burned. Do not attempt to touch it for at least 20 minutes or until it cools down completely if a need to touch it arises.
22. Do not pour water or any other liquids onto the infrared heat emitters. Do not bump, hit, or break the heating elements as it may cause an electrical short and pose a safety risk.
23. Do not make any modifications to the sauna, the sauna structure, or the sauna components.
24. Prior to each sauna session, the sauna room is to be inspected for correct operation. If for any reason your sauna does not seem to be operating properly, discontinue use and contact Customer Service.

## **Safeguards For Your Sauna**

1. Do not install the sauna near water, near a bathtub (if water will splash on the sauna), near a shower (if water will splash on the sauna), in a wet basement, or near a swimming pool (if water will splash on the sauna).
2. Do not use liquid cleaners or aerosol cleaners on the sauna. Unplug the sauna from the wall outlet before cleaning. Use plain water and a soft damp cloth for cleaning.
3. The power supply cord should be routed so that it is not walked on or pinched by any object that may be placed against it.
4. When replacement parts are required, be sure they meet the specified requirements of the manufacturer. Unauthorized substitutes may result in a fire, electrical shock, or other hazardous situations. After any repairs, please ask the service technician to perform a safety check to determine that the sauna is in good working order.
5. Do not use any wall receptacle adapter, surge protector, or extension cord between the sauna cord and wall outlet.



## Troubleshooting

	problem	possible reason	countermeasure
1	indicator light for power supply not working	The connector is not connected properly	Check the connector or replace a new one
		No power supply input	Check your circuit breaker to confirm power at the wall outlet
		Indicator light is broken	replace the circuit panel
2	Indicator light for function is not working	The heating indicator light is broken	Replace the relevant control panel
		The circuit board or components are broken	Replace the circuit board
		The temperature sensor is broken	check the connection of the temperature sensor
3	Infrared Heater not heating up	The heater is broken	Replace heater panel
		The wire junction or the heater's wire is not connected	Check that the connections are snug and tight
		The temperature sensor is broken	check the connection of the temperature sensor
		The circuit board or the relay is not working	replace the circuit board
4	Odor from the sauna	Power supply problem	Power supply may need to be replaced
5	Light bulb is not working	Light bulb is burned out	Remove burned out light bulb and replace it
		Light bulb wiring is loosen	Check connection and/or replace the lamp assembly
		Problems with electrical control panel	Replace the relevant control panel
6	Sauna is not powering up	Power cord is unplug	Plug the power cord into wall outlet
		Outlet has no power	Check your circuit breaker to confirm power at the wall outlet
		Power supply or circuit panel is broken	Replace the power supply or related circuit board
7	The temperature display shows "EP"	The connector of temperature sensor is loose, not connected, or sensor is damaged	Disconnect and reconnect the connector of temperature sensor or change to a new temperature sensor

8	The temperature display shows "H"	The temperature inside the sauna room is too high	Turn off the unit, and contact the manufacturer
9	Speaker does not work	The speaker is broken	Replace with a new one of the same specifications
		The speaker wire is loose	Disconnect and reconnect the speaker connections
		The power indicator light for CD is off	Turn on the switch to start work
10	CD-Player doesn't work	Power connector is loose or damage	Disconnect and reconnect the connection
		DC power supply has no power to the CD-player	Check DC power supply wiring or replace the power supply
		CD-player is defective	Replace the CD-player
		CD-player protection fuses is burnt out	Replace the fuses

## Maintenance

### Cleaning

Do not use liquid cleaners or aerosol cleansers inside the sauna. Unplug the sauna from the wall outlet before cleaning. Use plain water and a soft cloth for cleaning. **Do not use benzene, alcohol, or strong cleaning chemicals in or on the sauna. NOTE: Any chemical that can damage wood or be absorbed into the wood will damage the sauna.**

## Limited Lifetime Warranty

**5 Year Limited Warranty:** Golden Designs, Inc. under the Maxxus brand name warrants the wood, structure, heating elements, and electronics against defects in material and workmanship for a period of 1 to 5 years from the original date of purchase. **This sauna is for INDOOR use only. Placing your sauna outdoors will VOID this warranty. Any damage due to exposure to outdoor elements such as rain, snow, sun, wind or extreme temperatures will not be covered by this warranty. Any damages as a result of modifications made to the sauna or its components will void this warranty.**

**Extent of Warranty:** This limited warranty applies to products manufactured or distributed by Golden Designs, Inc. under the Maxxus brand name, delivered in the continental United States or Canada and extends to the original purchaser at the original site of installation only. This warranty becomes valid at time of purchase and terminates either by specified time frame listed above, owner transfer, or relocation. **Your sales receipt showing the date of purchase of the product is your proof of purchase. Warranty is not transferable.**

### Manufacturer Warranty

All Golden Designs, Inc. products are manufactured with the highest quality appliances and are warranted to be free from defects in material and workmanship at the time of delivery. The appliance warranty is extended through the manufacturer for the product including, but not limited to: stereos, CD/DVD players, etc. All exchanged parts and products replaced under this warranty will become the property of Golden Designs, Inc. Golden Designs, Inc. reserves the right to change manufactures of any part to cover any existing warranty. Any parts determined to be defective must be returned to Golden Designs, Inc. to obtain warranty service. You must prepay any shipping charges, export taxes, custom duties and taxes, or any other charges associated with the transportation of the parts. In addition you are responsible for insuring any parts shipped or returned. You must present Golden Designs, Inc. with proof of purchase documents (including the date of purchase). Any evidence of alteration, erasing or forgery of proof of purchase documents will be cause to **VOID** this limited warranty. Products on which the serial number has been defaced or removed is not eligible for warranty service. This warranty covers parts, but does not cover labor.

### Warranty Limitations

This warranty does not apply if the unit has been subject to full commercial use, negligence, alteration, modification, misuse, abuse, repairs by non-Golden Designs, Inc. authorized personnel, inappropriate installations, or any case beyond the control of Golden Designs, Inc. invalidating this warranty including but are not limited to:

- Use of lacquer or paints
- Sauna and other Golden Designs, Inc. products accessories placed on non-approved surfaces

- Outdoor applications
- Normal wear and tear or weathering
- Use of product not in accordance with instructions
- Worn out receptacle

**Surface cracks are not considered defects in material or workmanship, as they are normal characteristics of all woods. This includes minor cracks due to wood expansion and contraction. Note: Since the wood used in construction has been kiln dried, a certain amount of expansion and contraction occurs in the wood in a sauna environment.**

### **Disclaimers**

Golden Designs, Inc. shall not be liable for loss of use of sauna or other Golden Designs, Inc. products or other secondary or incidental or consequential costs, expense or damages - which may include the removal of permanent deck or other custom fixtures or the necessity for crane removal - arising directly or indirectly out of the use or inability to use the product. Any implied warranty shall have duration equal of the applicable warranty stated above. Under no circumstances shall Golden Designs, Inc. or any of its representatives be held liable for injury to any person or damage to any property, however arising. Specifications are subject to change without notice or obligation.

### **Legal Remedies**

This limited warranty gives you specific legal rights. You may have other rights, which may vary from state to state.

### **Customer Service**

For customer service, contact your authorized dealer. If you need additional information or assistance, please email Golden Designs, Inc. at [info@goldendesignsinc.com](mailto:info@goldendesignsinc.com) or call (909) 212-5555.

\*Limited Lifetime Warranty of Sauna Products is 5 years on heating elements and electronics from the date of purchase. The radio and wood structure have a 1 year limited warranty.

**WARRANTY CARD**

Congratulations on your purchase of an Infrared Sauna from Golden Designs, Inc. Please take the time to complete the following Warranty Card and mail it back to:

**Golden Designs, Inc.  
3550 Jurupa Street, Unit B  
Ontario, CA 91761**

Please include a copy of your sales receipt showing date of purchase as this will serve as proof of purchase.

**Warranty will be VOID if the following warranty card is not mailed back within 60 days of purchase date along with proof of purchase.**

**\*\*Serial number (S/N) is located on the sauna’s front panel, rear panel, or on the carton.\*\***

DETACH  
HERE



**WARRANTY CARD**

All fields must be completed to validate the

warranty. Name: \_\_\_\_\_

Address: \_\_\_\_\_

City: \_\_\_\_\_ State: \_\_\_\_\_ Zip Code: \_\_\_\_\_

Phone Number: \_\_\_\_\_

Purchase Date: \_\_\_\_\_

Purchase From: \_\_\_\_\_

Serial Number: \_\_\_\_\_